









Indhold af Motordele Inhåll av Motordelar

	Vandpumpe reparationskit138 Vattenpumpe reparationsatts138
	Boltsæt til motordæksel139 Bultsats för motorkåpa139
	Rem til oliepumpe139 Rem till oljepump139
	Oliepumpe140 Oljepump140
	Nåle lejer142 Nål lager142
	Pakningssæt, komplet, Max144 Packsats, komplet, Max144
	Pakningssæt, komplet, Centauro146 Packsats, komplet, Centauro146
	Motordæksel pakning, Max147 Motorkåpa packning, Max147
	Pakdåsesæt, motor, Max148 Packbox sats, motor, Max148
	Pakdåsesæt, motor, Centauro150 Packbox sats, motor, Centauro150
	Membranpakning, Max151 Membranpackning, Max151
	Krumtap, Max152 Vevparti, Max152
	Pejlstangkit153 Vevstakkit153
	Baghjulsaksel, Top Racing161 Bakhjulaxel, Top Racing118
	Blæserhjul for svinghjul154 Svinghjulsflækt154
	Krumtap, Top Racing156 Vevparti, Top Racing156
	Hovedlejer162 Huvudlager162
	Hovedlejer, pakdåsekit158 Huvudlager, packbox sats158
	Hjullejer163 Hjullager163
	Variator, komplet, Top Racing164 Variator, komplett, Top Racing164
	Drivremme167 Drivremmar167
	Drivremme170 Drivremmar170
	Variator ruller178 Variator rullar178
	Variator tilbehør179 Variator tillbehör179
	Koblingsplader og fjedre, Race Pro180/181 Kopplingslamellor och fjädre, Race Pro180/181
	Koblingsplader og fjedre, EBC181 Kopplingslamellor och fjädre, EBC181
	Remskive komplet med kobling182 Remskiva komplett med koppling182

	Remskive komplet med akse184 Remskiva komplett med axel184
	Remskive186 Remskiva186
	Koblingstrykfjeder, Centerkoblingsfjeder187 Tryckfjäder koppling, Centrumskopplingsfjäder187
	Remskive, racing188 Remskiva, racing188
	Centerkobling190 Centerkoppling190
	Kickpedal192 Kickpedal192
	Motordæksel ved kickstarter194 Motorkåpa vid kicken194
	Transmissionsdæksel195 Transmissionskåpa195
	Gear pedal194 Växelspark194
	Kickstarter akse196 Kickstart axel196
	Kickstarter tilbehør202 Kickstart tillbehör202
	Start kobling203 Start koppling203
	Blæser kappe204 Cylinder kåpa204
	Blæser dæksel205 Flækt kåpa205
	Køler kappe207 Kylarkåpa207
	Motordele til 4-taktere206 Motordelar till 4-taktare206



Forhandlere Återförsäljare s. 2
Stikord Sökord s. 4
Tøj/hjelme Kläder/ hjälmår s. 6
Dæk og slanger Däck och slangar s. 15
Olie / spray Olja / spray s. 26
Kæder / tandhjul Kedjor / drev s. 43
Bremse dele Bromsdelar s. 48
Låse Lås s. 93
Batteri Batteri s. 96
Cylinder / topstykke Cylinder / toplock s. 105
Motordele Motordelar s. 137
Karburator - Luftfilter Förgasare - Luftfilter s. 208
El-dele tændrør Elektriskt tændstift s. 222
Udstødning Avgassystem s. 246
Udfælg - Dæmpere - Dæmpere s. 260
Styrerør - Kabler Wire s. 272
Spejle Speglar s. 282
Blinklygter Baglygter Blinkers Baklygte s. 284
Støtteben Topboks, mm. Stödd Toppbox, mm s. 291
Rep. bøger værktøj Rep. böcker Verktyg s. 297

MÆRKE/MODEL	ÅRG.	Varenr.		
MÄRKE/MODELL	ÅRG.	Art.NR.	DKK	SEK
APRILIA				
Area 51 LC 50	98->	017600	199,-	249,-
Area 51 LC 50 (komplet)	98->	017604	199,-	249,-
RS 50 (AM6)	Alle	017603	199,-	249,-
RX 50 (AM6)	94-06	017603	199,-	249,-
Sonic LC 50	Alle	017604	199,-	249,-
SR-Racing, Stealth, Netscaper LC 50	Alle	017600	199,-	249,-
SR-Racing, Steal., Netsc. LC (kpl.) 50	Alle	017604	199,-	249,-
SR-Replica LC (Minarelli) 50	->00	017600	199,-	249,-
SR-Replica LC (Minarelli) 50 (kpl.)	->00	017604	199,-	249,-
SR-ditech 50 (Morini)	00>	017602	199,-	249,-

BETA				
Ark LC 50	Alle	017600	199,-	249,-
Komplet >		017604	199,-	249,-
RK 6 50	Alle	017603	199,-	249,-
RR 50	Alle	017603	199,-	249,-

CPI				
SM 50	Alle	017603	199,-	249,-
SX 50	Alle	017603	199,-	249,-

DERBI				
GPR 50	Alle	017606	199,-	249,-
Predator LC 50	Alle	017607	199,-	249,-
Senda 50	>06	017606	199,-	249,-

GENERIC				
Trigger SM 50	Alle	017603	199,-	249,-
Trigger X 50	Alle	017603	199,-	249,-

GILERA				
RCR 50 Off-road	>06	017606	199,-	249,-
Runner LC 50	Alle	017601	199,-	249,-
Runner SP LC 50	02->	017601	199,-	249,-
SMT 50 Motard	>06	017606	199,-	249,-

ITALJET				
Dragster 50 LC	Alle	017605	199,-	249,-

MALAGUTI				
50 LC	Alle	017600	199,-	249,-
50 LC (komplet)	Alle	017604	199,-	249,-

PEUGEOT				
XPS 50	Alle	017603	199,-	249,-
XP6 50	Alle	017603	199,-	249,-
XR 6 50	Alle	017603	199,-	249,-

RIEJU				
Alle modeller (m. AM-6 motor) 50 cc	Alle	017603	199,-	249,-

SUZUKI				
Katana 50 LC	Alle	017602	199,-	249,-

YAMAHA				
DT 50	95-03	017603	199,-	249,-
50 LC	Alle	017600	199,-	249,-
50 LC (komplet)	Alle	017604	199,-	249,-
TZR 50 (AM6)	Alle	017603	199,-	249,-

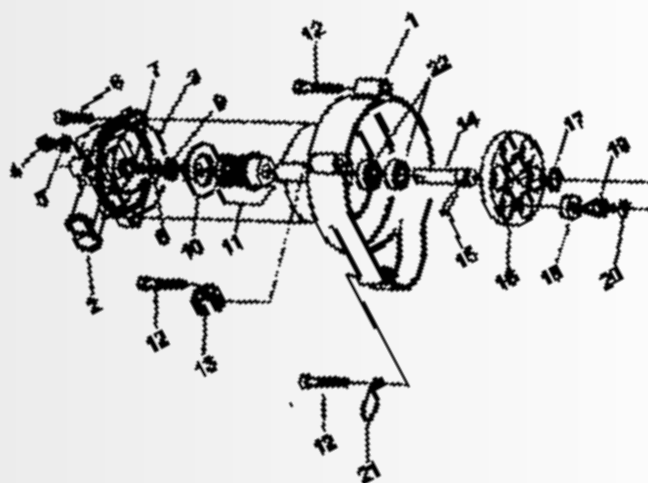
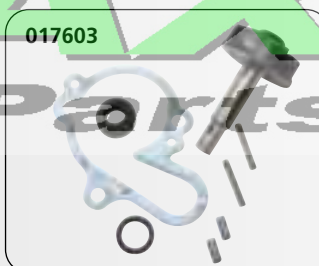

PRO COOL

En færdigblandet ugiftig kølevæske. Beskytter mod korrosion og luftbobler. Pro Cool er frostsikret ned til -35 grader C. Racer- og gadebikler kan bruge den året rundt.

Færdigblandad och ogiftig kylarvätska. Frostsäker ner till -35°C. Kan användas året runt och skyddar mot korrosion och luftbubblor.

Varenr./Art.nr. 755010010
1 liter, ks. å 6 stk. **DKK 73,-** **SEK 91,-**

Varenr./Art.nr. 755010250
25 liter **DKK 1346,-** **SEK 1683,-**



BOLTSÆT FOR MOTORDÆKSEL
BULTSATS FÖR MOTORKÅPA



M.ÆRKE/MODEL	ÅRG.	Varenr.		
MÄRKE/MODELL	ÅRG.	Art.NR.	DKK	SEK
APRILIA				
Sonic 50	Alle	111300	51,-	64,-
CPI				
Aragon 50 (Euro 2)	Alle	111300	51,-	64,-
Formula R 50 (Euro 2)	Alle	111300	51,-	64,-
Hussar 50	Alle	111300	51,-	64,-
Oliver/City 50 (Euro 2)	Alle	111300	51,-	64,-
Popcorn 50	Alle	111300	51,-	64,-
GENERIC				
Ideo 50	Alle	111300	51,-	64,-
XOR 2 50	Alle	111300	51,-	64,-
Race 50	Alle	111300	51,-	64,-
KEEWAY				
F-act 50	Alle	111300	51,-	64,-
Flash 50	Alle	111300	51,-	64,-
Focus 50	Alle	111300	51,-	64,-
Matrix 50	Alle	111300	51,-	64,-
TMP				
Baboon 50	Alle	111300	51,-	64,-
Gazelle 50	Alle	111300	51,-	64,-
YAMAHA				
Jog (CY-50)	Alle	111300	51,-	64,-

111300

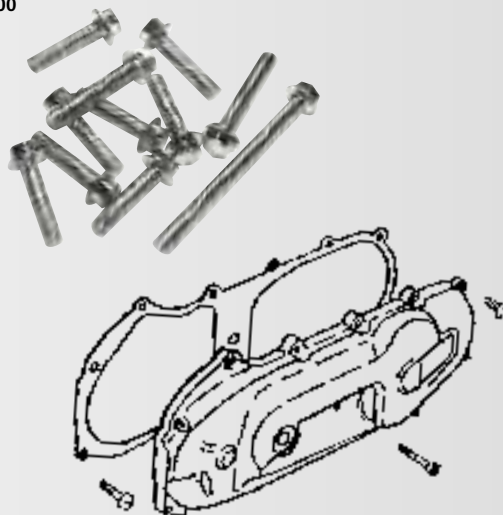

Forhandlere
Återförsäljare s. 2

Stikord
Sökord s. 4

Tøj/hjelme
Kläder/
hjälmår s. 6

Dæk og
slanger
Däck och
slangår s. 15

Olje / spray
Olja / spray s. 26

Kæder /
tandhjul
Kedjor /
drev s. 43

Bremselede
Bromsdelar s. 48

Låse
Lås s. 93

Batteri
Batteri s. 96

Cylinder /
topstykke
Cylinder /
topplock s. 105

**Motordele
Motordeklar s. 137**

Karburator
- Luftfilter
Förgasare
- Luftfilter s. 208

El-dele
tændrør
Elektriskt
tändstift s. 222

Udstødning
Avgassystem s. 246

Forgaffel
Støddæmpere
Framgaffel
Støtdämpare s. 260

Kabler
Wire s. 266

Styr og
greb
Styre och
handtag s. 272

Spejle
Speglar s. 282

Blinklygter
Baglygter
Blinkers
Baklykte s. 284

Støtteben
Topboks, mm.
Stödd
Toppbox, mm s. 291

Rep. bøger
værktøj
Rep. böcker
Verktyg s. 297



MAX
MOTORCYCLE PARTS

REM TIL OLIEPUMPE
REM TILL OLJEPUMP

Passer på **Piaggio modellerne**: Free 50, Liberty 50, NRG 50, NTT 50, Quartz 50, Sfera 50, Vespa ET2 50, Zip 50. og **Gilera modellerne**: Easy moving 50, Runner 50, Stalker 50, Storm 50, Typhoon 50.

OEMnr.: 286162

Varenr. 038200 **DKK 68,-** **SEK 85,-**

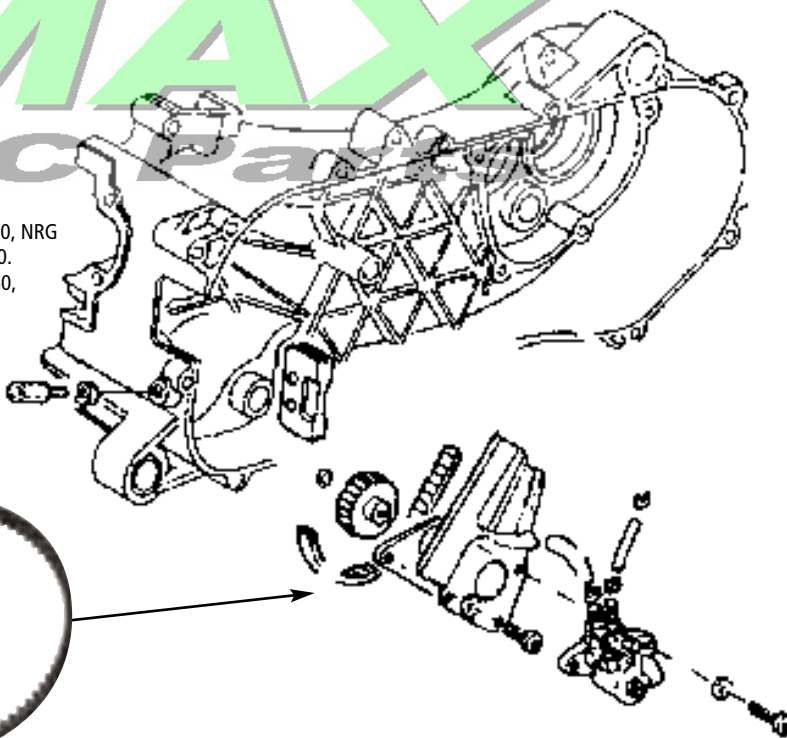

MÆRKE/MODEL	ÅRG.	Varenr.			
MÄRKE/MODELL	ÅRG.	Art.NR.	DKK	SEK	
AVANTI					
9 N 50 (4 t.)	Alle	110067	99,-	124,-	
Sport Classic 50 (4 t.)	Alle	110067	99,-	124,-	
Eagle 50 (4 t.)	Alle	110067	99,-	124,-	
Avanti Wolf 50 (4 t.)	Alle	110067	99,-	124,-	
BAOTAIN					
BT49QT-7	Alle	110067	99,-	124,-	
BT49QT-9	Alle	110067	99,-	124,-	
BT49QT-11	Alle	110067	99,-	124,-	
BT49QT-12C	Alle	110067	99,-	124,-	
BT49QT-12	Alle	110067	99,-	124,-	
BENDA					
Scout 50 (4 t.)	Alle	110067	99,-	124,-	
CPI					
Aragon 50 (Euro 2)	Alle	110075	549,-	686,-	
Formula R 50 (Euro 2)	Alle	110075	549,-	686,-	
Hussar 50	Alle	110075	549,-	686,-	
Oliver/City 50 (Euro 2)	Alle	110075	549,-	686,-	
Popcorn 50	Alle	110075	549,-	686,-	
FYM					
QT 50 (4 t.)	Alle	110067	99,-	124,-	
GENERIC					
Ideo 50	Alle	110075	549,-	686,-	
Race 50	Alle	110067	99,-	124,-	
Xor 50	Alle	110075	549,-	686,-	
GIANTCO					
G-Buddy 50 (4 t.)	Alle	110067	99,-	124,-	
Sprint 50 (4 t.)	Alle	110067	99,-	124,-	
Stealth 50 (4 t.)	Alle	110067	99,-	124,-	
Venus 50 (4 t.)	Alle	110067	99,-	124,-	
HOOPER					
One 50 (4 t.)	Alle	110067	99,-	124,-	
HYOSUNG					
SB 50 M (Cab)	99>	110096	898,-	1123,-	
SF 50 B (Racing)	00>	110096	898,-	1123,-	
SF 50 R (Rally)	00>	110096	898,-	1123,-	
KEEWAY					
F-act 50	Alle	110075	549,-	686,-	
Flash 50	Alle	110075	549,-	686,-	
Focus 50	Alle	110075	549,-	686,-	
Matrix 50	Alle	110075	549,-	686,-	

MÆRKE/MODEL	ÅRG.	Varenr.			
MÄRKE/MODELL	ÅRG.	Art.NR.	DKK	SEK	
KYMCO					
Agility 50 (4 t.)	Alle	110067	99,-	124,-	
Super 8 50 (4 t.)	Alle	110067	99,-	124,-	
PEUGEOT					
V-Clic 50 (4 t.)	Alle	110067	99,-	124,-	
PEXMA					
KDQT 50 (4 t.)	Alle	110067	99,-	124,-	
PGO					
Big Max 50	Alle	110076	427,-	534,-	
Black Magic 50	Alle	110076	427,-	534,-	
Bubu 50	Alle	110076	427,-	534,-	
Dr. Big 50	Alle	110076	427,-	534,-	
Galaxy 50	Alle	110076	427,-	534,-	
G-Max 50	Alle	110076	427,-	534,-	
Hot-50	Alle	110076	427,-	534,-	
Ligero 50	Alle	110076	427,-	534,-	
PMS 50	Alle	110076	427,-	534,-	
PMX 50	Alle	110076	427,-	534,-	
Rodoshow 50	Alle	110076	427,-	534,-	
Streetfighter 50	Alle	110076	427,-	534,-	
T-Rex 50	Alle	110076	427,-	534,-	
Tornado 50	Alle	110076	427,-	534,-	
White Magic 50	Alle	110076	427,-	534,-	
SANELI					
Bahne 50 (4 t.)	Alle	110067	99,-	124,-	
TEXAS					
Chili 50 (4 t.)	Alle	110067	99,-	124,-	
City 50 (4 t.)	Alle	110067	99,-	124,-	
Flash 50 (4 t.)	Alle	110067	99,-	124,-	
Free 50 (4 t.)	Alle	110067	99,-	124,-	
TMS					
Retro 50 (4 t.)	Alle	110067	99,-	124,-	
S3 50 (4 t.)	Alle	110067	99,-	124,-	
Z2 50 (4 t.)	Alle	110067	99,-	124,-	
YIYING					
Stranger 50 (4 t.)	Alle	110067	99,-	124,-	

110067



110075



110076





Beta
the play bike

ARK 50 TRIBE

- STEL:** Stålrørstel.
- MOTOR:** Minarellimotor.
Luftkølet. En 49 cc cylinder.
2-takt. Dell'Orto karburator.
CVT gear.
- HJUL:** For: 13" / 190 mm. bremseskive.
Bag: 13" / 110,5 mm. bremseskive.
- LÆNGDE:** 1740 mm.
- BREDDE:** 750 mm.
- SÆDEHØJDE:** 830 mm.
- TØRVÆGT:** 84 kg.
- FORGAFFEL:** 32 mm. hydraulisk.
Monodæmper bag.

30 el. 45 km/t
15.998,-
Ekskl. leveringsomkostninger

MADE IN ITALY!

Læs mere på www.betamotor.dk



Beta anbefaler
Silkolene
olie!

Importør: **SCANMI** Tlf. +45 73 15 11 00

Design og produktion 100 % italiensk!



MC Parts

generic XOR2 50CC RACE IDEO TRIGGER X **TRIGGER SM** XOR2 125CC

TRIGGER SM

30 el. 45 km/t
14.998,-
+ leveringsomkostninger

DEN INNOVATIVE SUPER MOTARD!

Det er tid til at brænde noget gummi af! TRIGGER SM er lig med avanceret og banebrydende teknologi – du er garanteret høj køreglæde og en præstation i topklasse! Udstyr, som "up-side-down" forgaffel, skivebremser, håndbeskyttere og lette alufælg, gør køreturen til en ren nydelse!

- MOTOR:** En cylinder, vandkølet, 2-takts motor.
49,6 cc. Kompression 7:1.
- TRANSMISSION:** 45 km: 6 gear, fodskifte. Kædetræk.
30 km: 3 gear, fodskifte. Kædetræk.
- STEL:** Rørramme i stål
- AFFJEDRING:** For: Upside down forgaffel
Bag: Mono shock dæmper
- BREMSER:** For: Waveskive Ø 280 mm
Bag: Waveskive Ø 220 mm
- HJUL:** For: 100/80 x 17 / Bag: 130/80 x 17
- LÆNGDE:** 2035 mm
- VÆGT:** 94 kg
- TANK:** 10 liter
- FARVE:** Sort • sort/orange • hvid/sort

Silkolene
smøremidler anbefales
af Generic Motors! ...



Gemt udstødning bag



Elektronisk instrumentbræt



Wavebremseskive for/bag

DESIGN AUSTRIA
www.genericmotor.dk

SCANMI
Importør: ScanMI ApS
Tlf. +45 73 15 11 00



Märke/model	Årg.	Varenr.	Mål d.*D.*B.		
Märke/modell	Årg.	Art.nr.	Mått d.*D.*B.	DKK	SEK
ADLY					
Cat 50	Alle	300875	10*14*12,5 mm	49,-	61:-
Jet 50	Alle	300875	10*14*12,5 mm	49,-	61:-
Silver Fox 50	Alle	300875	10*14*12,5 mm	49,-	61:-
Super Sonic 50	Alle	300875	10*14*12,5 mm	49,-	61:-
Thunder Bike 50	Alle	300875	10*14*12,5 mm	49,-	61:-
APRILIA					
Amico 50	Alle	300875	10*14*12,5 mm	49,-	61:-
Area 51 LC 50	98->	300875	10*14*12,5 mm	49,-	61:-
Classic 50	Alle	300876	12*15*16,6 mm	49,-	61:-
Gulliver 50	Alle	300875	10*14*12,5 mm	49,-	61:-
Habana AC (Morini) 50	Alle	300875	10*14*12,5 mm	49,-	61:-
MX 50	Alle	300876	12x15x16,6 mm	49,-	61:-
Rally AC 50	Alle	300875	10*14*12,5 mm	49,-	61:-
RS-50	Alle	300876	12*15*16,6 mm	49,-	61:-
RX-50	Alle	300876	12*15*16,6 mm	49,-	61:-
Scarabeo 50	Alle	300875	10*14*12,5 mm	49,-	61:-
Scarabeo Ditech (Morini) 50	02->	300878	12*16*16 mm	49,-	61:-
Sonic AC 50	98->	300875	10*14*12,5 mm	49,-	61:-
Sonic LC 50	Alle	300875	10*14*12,5 mm	49,-	61:-
SR - Ditech (Morini) 50	Alle	300878	12*16*16 mm	49,-	61:-
SR - www AC 50	97->	300875	10*14*12,5 mm	49,-	61:-
SR-50 AC	Alle	300875	10*14*12,5 mm	49,-	61:-
SR-Racing 50, Stealth, Netscaper LC	Alle	300875	10*14*12,5 mm	49,-	61:-
SR-Replica LC (Minarelli) 50	->00	300875	10*14*12,5 mm	49,-	61:-
SR-Replica-2000 LC (Morini) 50	00->	300878	12*16*16 mm	49,-	61:-
SX 50	07->	134036	12x15x15 mm	53,-	66:-
ATALA					
Carosello 50	Alle	300875	10*14*12,5 mm	49,-	61:-
Hacker AT-12 50	Alle	300878	12*16*16 mm	49,-	61:-
Hacker LC 50	Alle	300878	12*16*16 mm	49,-	61:-
Skeggia 50	Alle	300878	12*16*16 mm	49,-	61:-
BENELLI					
491 GT 50	97->	300875	10*14*12,5 mm	49,-	61:-
491 Sport 50	97->	300875	10*14*12,5 mm	49,-	61:-
K2/LC 50	Alle	300875	10*14*12,5 mm	49,-	61:-
BETA					
Ark AC 50	Alle	300875	10*14*12,5 mm	49,-	61:-
Ark LC 50	Alle	300875	10*14*12,5 mm	49,-	61:-
Enduro 50	Alle	300876	12*15*16,6 mm	49,-	61:-
Paddock 50	Alle	300876	12*15*16,6 mm	49,-	61:-
CAGIVA					
Progress (Derbi) 50	Alle	300878	12*16*16 mm	49,-	61:-
CPI					
Aragon 50 (Euro 2)	Alle	134035	12*16*13 mm	58,-	73:-
ATV 50 cc		300875	10*14*12,5 mm	49,-	61:-
Hussar 50 - (12 mm.)	Alle	134035	12*16*13 mm	58,-	73:-
Formula R 50 (Euro 2)	Alle	134035	12*16*13 mm	58,-	73:-
GTR 50					
Oliver/City 50 (Euro 2)	Alle	134035	12*16*13 mm	58,-	73:-
Popcorn 50 - (10 mm.)	Alle	300875	10*14*12,5 mm	49,-	61:-
Popcorn 50	Alle	300876	12*15*16,6 mm	49,-	61:-
Super Moto 50	Alle	300876	12*15*16,6 mm	49,-	61:-
CPI - alle nye modeller (12 mm.)	03->	134035	12*16*13 mm	58,-	73:-

Märke/model	Årg.	Varenr.	Mål d.*D.*B.		
Märke/modell	Årg.	Art.nr.	Mått d.*D.*B.	DKK	SEK
DAELIM					
S-Five 50	Alle	300879	12*17*13 mm	47,-	59:-
DERBI					
Atlantis 50	Alle	300875	10*14*12,5 mm	49,-	61:-
Atlantis 50	03->	300879	12*17*13 mm	47,-	59:-
GP1 50	03->	300879	12*17*13 mm	47,-	59:-
GPR 50	Alle	134036	12*15*15 mm	53,-	66:-
Hunter 50	Alle	300875	10*14*12,5 mm	49,-	61:-
Manhattan 50	Alle	300875	10*14*12,5 mm	49,-	61:-
MotoGP (GP1) 50	Alle	300875	10*14*12,5 mm	49,-	61:-
Paddock LC 50	Alle	300875	10*14*12,5 mm	49,-	61:-
Predator LC 50	Alle	300875	10*14*12,5 mm	49,-	61:-
Senda R 50	Alle	134036	12*15*15 mm	53,-	66:-
Senda SM X-treme 50	Alle	134036	12*15*15 mm	53,-	66:-
Vamos (Morini) 50	Alle	300875	10*14*12,5 mm	49,-	61:-
FALCON					
Big Wheel 50	Alle	300875	10*14*12,5 mm	49,-	61:-
Star-50	Alle	300875	10*14*12,5 mm	49,-	61:-
GENERIC					
Ideo 50 - (12 mm.)	Alle	134035	12*16*13 mm	58,-	73:-
Race 50	10>	134035	12*16*13 mm	58,-	73:-
Trigger SM 50	Alle	300876	12*15*16,6 mm	49,-	61:-
Trigger X 50	Alle	300876	12*15*16,6 mm	49,-	61:-
Xor 50 - (12 mm.)	Alle	134035	12*16*13 mm	58,-	73:-
GIANTCO					
G-10 50	Alle	134035	12*16*13 mm	58,-	73:-
Lambros 50	Alle	134035	12*16*13 mm	58,-	73:-
Spartan 50	Alle	134035	12*16*13 mm	58,-	73:-
GILERA					
DNA LC 50	Alle	300879	12*17*13 mm	47,-	59:-
ICE AC 50	Alle	300879	12*17*13 mm	47,-	59:-
RCR Off-road 50	Alle	300876	12*15*16,6 mm	49,-	61:-
Runner AC 50	Alle	300879	12*17*13 mm	47,-	59:-
Runner LC 50	Alle	300879	12*17*13 mm	47,-	59:-
Runner PJ 50	03->	300879	12*17*13 mm	47,-	59:-
Runner SP LC 50	02->	300879	12*17*13 mm	47,-	59:-
SMT Motard 50	Alle	134036	12*15*15 mm	53,-	66:-
Stalker 50	Alle	300879	12*17*13 mm	47,-	59:-
Storm 50	Alle	300879	12*17*13 mm	47,-	59:-
Typhoon 50	>01	300879	12*17*13 mm	47,-	59:-
Typhoon-X 50	02->	300879	12*17*13 mm	47,-	59:-
HONDA					
SFX 50	Alle	134006	12*17*14 mm	82,-	103:-
Sky 50	Alle	134006	12*17*14 mm	82,-	103:-
Vision Met In 50	Alle	300875	10*14*12,5 mm	49,-	61:-
Vision SA 50	Alle	300875	10*14*12,5 mm	49,-	61:-
Wallaroo 50	Alle	300877	12*15*16,5 mm	49,-	61:-
X8-R 50	Alle	134006	12*17*14 mm	82,-	103:-
HYOSUNG					
SB 50 M (Cab)	Alle	300875	10*14*12,5 mm	49,-	61:-
SF 50 B (Racing)	Alle	300875	10*14*12,5 mm	49,-	61:-
SF 50 R (Rally)	Alle	300875	10*14*12,5 mm	49,-	61:-

Mærke/model	Årg.	Varenr.	Mål d.*D.*B.		
Märke/modell	Årg.	Art.nr.	Mått d.*D.*B.	DKK	SEK
ITALJET					
Formula 50	Alle	300875	10*14*12,5 mm	49,-	61,-
Velocifero 50	Alle	300875	10*14*12,5 mm	49,-	61,-
KEEWAY					
F-act 50	Alle	134035	12*16*13 mm	58,-	73,-
Flash 50	Alle	134035	12*16*13 mm	58,-	73,-
Focus 50 - (12 mm.)	Alle	134035	12*16*13 mm	58,-	73,-
Hurricane 50	Alle	134035	12*16*13 mm	58,-	73,-
Matrix 50 - (12 mm.)	Alle	134035	12*16*13 mm	58,-	73,-
KREIDLER					
Easy Rider 50	Alle	300875	10*14*12,5 mm	49,-	61,-
KYMCO					
Fever ZX 50	Alle	300879	12*17*13 mm	47,-	59,-
K-12 50	Alle	300879	12*17*13 mm	47,-	59,-
NZ-50 Super Fever	03->	300879	12*17*13 mm	47,-	59,-
People 50	Alle	300879	12*17*13 mm	47,-	59,-
Super 9 50	Alle	300879	12*17*13 mm	47,-	59,-
Vitality 50	Alle	300879	12*17*13 mm	47,-	59,-
MALAGUTI					
F10 AC 50	Alle	300875	10*14*12,5 mm	49,-	61,-
F12 Phantom AC 50	Alle	300875	10*14*12,5 mm	49,-	61,-
F15 Firefox LC 50	Alle	300875	10*14*12,5 mm	49,-	61,-
PEUGEOT					
Buxy 50	94->	134036	12*15*15 mm	53,-	66,-
Elyseo 50	Alle	134036	12*15*15 mm	53,-	66,-
Elystar 50	Alle	134036	12*15*15 mm	53,-	66,-
Fox 25 50	03->	134036	12*15*15 mm	53,-	66,-
Jet Force 50	Alle	134036	12*15*15 mm	53,-	66,-
Looxor 50	Alle	134036	12*15*15 mm	53,-	66,-
Ludix 50	Alle	134036	12*15*15 mm	53,-	66,-
Ludix One 50	Alle	134036	12*15*15 mm	53,-	66,-
Ludix Classic 50	Alle	134036	12*15*15 mm	53,-	66,-
Ludix Snake 50	Alle	134036	12*15*15 mm	53,-	66,-
Speedake 50	95->	134036	12*15*15 mm	53,-	66,-
Speedfight AC/LC 50	Alle	134036	12*15*15 mm	53,-	66,-
Speedfight LC 50	Alle	134036	12*15*15 mm	53,-	66,-
Speedfight 3 50	Alle	134036	12*15*15 mm	53,-	66,-
Squab 50	95->	134036	12*15*15 mm	53,-	66,-
TKR 50	Alle	134036	12*15*15 mm	53,-	66,-
Trekker 50	98->	134036	12*15*15 mm	53,-	66,-
Trekker/Metal X 50	03->	134036	12*15*15 mm	53,-	66,-
Vivacity 50	Alle	134036	12*15*15 mm	53,-	66,-
XP 6 50	Alle	300876	12*15*16,6 mm	49,-	61,-
XR 6 50	Alle	300876	12*15*16,6 mm	49,-	61,-
Zenith 50	94->	134036	12*15*15 mm	53,-	66,-
PGO					
Big Max 50	Alle	300875	10*14*12,5 mm	49,-	61,-
Black Magic 50	Alle	300875	10*14*12,5 mm	49,-	61,-
Bubu 50	Alle	300875	10*14*12,5 mm	49,-	61,-
Comet 50	Alle	300875	10*14*12,5 mm	49,-	61,-
Dr. Big 50	Alle	300875	10*14*12,5 mm	49,-	61,-
Galaxy 50	Alle	300875	10*14*12,5 mm	49,-	61,-
G-Max 50	Alle	300875	10*14*12,5 mm	49,-	61,-
Hot-50	Alle	300875	10*14*12,5 mm	49,-	61,-
Ligero 50	Alle	300875	10*14*12,5 mm	49,-	61,-
PMS 50	Alle	300875	10*14*12,5 mm	49,-	61,-
PMX 50	Alle	300875	10*14*12,5 mm	49,-	61,-
Rodoshow 50	Alle	300875	10*14*12,5 mm	49,-	61,-
Streetfighter 50	Alle	300875	10*14*12,5 mm	49,-	61,-
T-Rex 50	Alle	300875	10*14*12,5 mm	49,-	61,-
Tornado 50	Alle	300875	10*14*12,5 mm	49,-	61,-
PIAGGIO/VESPA					
ET2 50	97->	300879	12*17*13 mm	47,-	59,-
Free 50	Alle	300879	12*17*13 mm	47,-	59,-
Fly 50	Alle	300879	12*17*13 mm	47,-	59,-
Liberty 50	Alle	300879	12*17*13 mm	47,-	59,-
NRG Extreme MC3 AC 50	Alle	300879	12*17*13 mm	49,-	59,-
NRG Extreme MC3 LC 50	Alle	300879	12*17*13 mm	49,-	59,-
NRG MC-2 LC 50	94->	300879	12*17*13 mm	49,-	59,-
Typhoon 50	Alle	300879	12*17*13 mm	49,-	59,-
Typhoon-X 50	Alle	300879	12*17*13 mm	49,-	59,-
Zip 2000 50	00->	300879	12*17*13 mm	49,-	59,-
Zip 50	93->	300879	12*17*13 mm	49,-	59,-

Mærke/model	Årg.	Varenr.	Mål d.*D.*B.		
Märke/modell	Årg.	Art.nr.	Mått d.*D.*B.	DKK	SEK
PUCH					
Maxi P-K 50	Alle	300876	12*15*16,6 mm	49,-	61,-
RIEJU					
Alle modeller 50 cc (m. AM-6 motor)	Alle	300876	12*15*16,6 mm	49,-	61,-
SUZUKI					
Adress AP-50	Alle	300875	10*14*12,5 mm	49,-	61,-
Estilete, UF-50	Alle	300875	10*14*12,5 mm	49,-	61,-
FZ-50	Alle	300878	12*16*16 mm	49,-	61,-
K 50	Alle	300878	12*16*16 mm	49,-	61,-
Katana AY-50 AC	Alle	300875	10*14*12,5 mm	49,-	61,-
Katana AY-50 LC Alstare	Alle	300878	12*16*16 mm	49,-	61,-
Katana AY-50 LC	Alle	300878	12*16*16 mm	49,-	61,-
RMX 50	Alle	300878	12*16*16 mm	49,-	61,-
SMX 50	Alle	300878	12*16*16 mm	49,-	61,-
Street Magic 50	Alle	300875	10*14*12,5 mm	49,-	61,-
TS 50 X	Alle	300878	12*16*16 mm	49,-	61,-
Zillion LC 50	Alle	300878	12*16*16 mm	49,-	61,-
SYM					
DD 50	Alle	300879	12*17*13 mm	47,-	59,-
Jet 50	Alle	300879	12*17*13 mm	47,-	59,-
Jet Euro 50	Alle	300879	12*17*13 mm	47,-	59,-
Jungle 50	Alle	300879	12*17*13 mm	47,-	59,-
Super Fancy 50	Alle	300879	12*17*13 mm	47,-	59,-
TGB/TOBI					
101 R/S 50	Alle	300875	10*14*12,5 mm	49,-	61,-
303/309 50	Alle	300875	10*14*12,5 mm	49,-	61,-
Akros 50	Alle	300875	10*14*12,5 mm	49,-	61,-
Delivery 50	Alle	300875	10*14*12,5 mm	49,-	61,-
TMP					
Baboon 50	Alle	300875	10*14*12,5 mm	49,-	61,-
Gazelle 50	Alle	300875	10*14*12,5 mm	49,-	61,-
YAMAHA					
Aerox 50	97->	300875	10*14*12,5 mm	49,-	61,-
ATV 50 cc	Alle	300875	10*14*12,5 mm	49,-	61,-
Axis 50	95->	300875	10*14*12,5 mm	49,-	61,-
Bump 50	97->	300875	10*14*12,5 mm	49,-	61,-
BW's 50	Alle	300875	10*14*12,5 mm	49,-	61,-
BW's N.G. 50	Alle	300875	10*14*12,5 mm	49,-	61,-
DT 50	Alle	300876	12*15*16,6 mm	49,-	61,-
DT-50LC	Alle	300876	12*15*16,6 mm	49,-	61,-
DT-50R	Alle	300876	12*15*16,6 mm	49,-	61,-
FS1/K/DX	Alle	300876	12*15*16,6 mm	49,-	61,-
Jog Artistic -Fine Selection	Alle	300875	10*14*12,5 mm	49,-	61,-
Jog Space Innovation 50	98->	300875	10*14*12,5 mm	49,-	61,-
Jog-R 50	03->	300875	10*14*12,5 mm	49,-	61,-
Jog-RR 50	03->	300875	10*14*12,5 mm	49,-	61,-
Neo's 50	Alle	300875	10*14*12,5 mm	49,-	61,-
Slider 50	01->	300875	10*14*12,5 mm	49,-	61,-
Spy 50	Alle	300875	10*14*12,5 mm	49,-	61,-
TZR 50	Alle	300876	12*15*16,6 mm	49,-	61,-
Why 50	99->	300875	10*14*12,5 mm	49,-	61,-

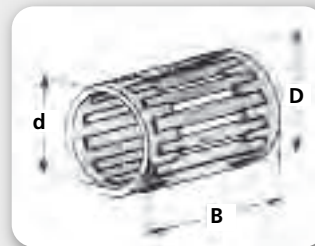

d = indiv. mål i mm.
D = udv. mål i mm.
B = Længde i mm.

Max pakningssæt er under løbende kontrol, og overholder de originale mål og kvalitetskrav, så der aldrig opstår problemer med holdbarhed. Pakningerne er pakket i kraftig beskyttet skin-pack emballage. Et godt valg!

Max pakninger kontrolleres løpende og er af original kvalitet eller bedre, så det aldrig opstår problem men holdbarheden. Pakningerne er forpackede i et kraftigt og skyddende emballage. Mycket prisvärt!

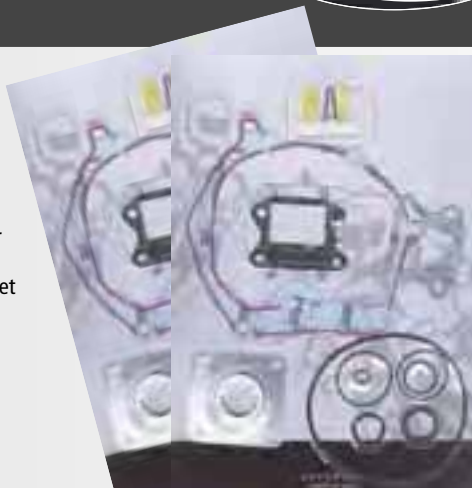

MÆRKE/MODEL	ÅRG.	Varenr.		
MÄRKE/MODELL	ÄRG.	Art.NR.	DKK	SEK
ADLY				
Cat 50	Alle	800100	99,-	124,-
Jet 50	Alle	800101	99,-	124,-
Silver Fox 50	Alle	800100	99,-	124,-
Super Sonic 50	Alle	800101	99,-	124,-
Thunder Bike 50	Alle	800101	99,-	124,-
APRILIA				
Amico 50	Alle	800102	99,-	124,-
Area 51 LC 50	Alle	800103	99,-	124,-
Classic 50	Alle	800104	99,-	124,-
Gulliver AC 50	Alle	800105	99,-	124,-
Habana AC (Morini) 50	Alle	800106	99,-	124,-
MX 50	Alle	800104	99,-	124,-
Rally AC 50	Alle	800105	99,-	124,-
RS-50	Alle	800104	99,-	124,-
RX-50	Alle	800104	99,-	124,-
Scarabeo AC 50	Alle	800105	99,-	124,-
Sonic AC 50	Alle	800108	99,-	124,-
Sonic LC 50	Alle	800103	99,-	124,-
SR 50 AC	Alle	800105	99,-	124,-
SR - www AC 50	Alle	800105	99,-	124,-
SR-Racing 50, Stealth, Netscaper LC	Alle	800103	99,-	124,-
SR-Replica LC 50 (Minarelli)	Alle	800103	99,-	124,-
SX 50	07->	800135	99,-	124,-
ATALA				
Carosello 50	Alle	800105	99,-	124,-
Hacker AT-12 50	Alle	800106	99,-	124,-
Hacker LC 50	Alle	800107	99,-	99,-
Skeggia 50	Alle	800106	99,-	124,-
AVANTI				
9 N 50 (4 t.)	Alle	800134	99,-	124,-
Sport Classic 50 (4 t.)	Alle	800134	99,-	124,-
Eagle 50 (4 t.)	Alle	800134	99,-	124,-
Avanti Wolf 50 (4 t.)	Alle	800134	99,-	124,-
BAOTAIN				
BT49QT-7 50 (4 t.)	Alle	800134	99,-	124,-
BT49QT-9 50 (4 t.)	Alle	800134	99,-	124,-
BT49QT-11 50 (4 t.)	Alle	800134	99,-	124,-
BT49QT-12C 50 (4 t.)	Alle	800134	99,-	124,-
BT49QT-12 50 (4 t.)	Alle	800134	99,-	124,-
BENDA				
Scoot 50 (4 t.)	Alle	800134	99,-	124,-
BENELLI				
491 GT 50	Alle	800105	99,-	124,-
491 Sport 50	Alle	800105	99,-	124,-
K2/LC 50	Alle	800103	99,-	124,-
BETA				
Ark AC 50	Alle	800105	99,-	124,-
Ark/LC 50	Alle	800103	99,-	124,-
CPI				
Aragon 50 (Euro 2)	Alle	800133	99,-	124,-
ATV 50 cc		800133	99,-	124,-
Formula 50 (Euro 2)	Alle	800133	99,-	124,-
GTR 50	Alle	800133	99,-	124,-
Hussar 50	Alle	800133	99,-	124,-
Oliver/City 50 (Euro 2)	Alle	800133	99,-	124,-
Popcorn 50	Alle	800133	99,-	99,-
Super Cross 50				
Super Motard 50				

MÆRKE/MODEL	ÅRG.	Varenr.		
MÄRKE/MODELL	ÄRG.	Art.NR.	DKK	SEK
DERBI				
Atlantis 50	Alle	800111	99,-	124,-
GP-1 50	Alle	800111	99,-	124,-
GPR 50	Alle	800109	99,-	124,-
Hunter 50	Alle	800111	99,-	124,-
Manhattan 50	Alle	800111	99,-	124,-
Paddock AC 50	Alle	800111	99,-	124,-
Predator 50	Alle	800111	99,-	124,-
Senda R 50	>06	800109	99,-	124,-
Senda SM X-treme 50	07>	800135	99,-	124,-
Vamos (Morini) 50	Alle	800106	99,-	124,-
FALCON				
Big Wheel 50	Alle	800105	99,-	124,-
Star-50	Alle	800105	99,-	124,-
FYM				
QT 50 (4 t.)	Alle	800134	99,-	124,-
GENERIC				
Ideo 50	Alle	800133	99,-	124,-
Race 50	Alle	800133	99,-	124,-
Xor 50	Alle	800133	99,-	124,-
GIANTCO				
G-Buddy 50 (4 t.)	Alle	800134	99,-	124,-
Sprint 50 (4 t.)	Alle	800134	99,-	124,-
Stealth 50 (4 t.)	Alle	800134	99,-	124,-
Venus 50 (4 t.)	Alle	800134	99,-	124,-
GILERA				
DNA LC 50	Alle	800110	99,-	124,-
ICE AC 50	Alle	800111	99,-	124,-
RCR Off-road 50	Alle	800109	99,-	124,-
Runner AC 50	Alle	800111	99,-	124,-
Runner LC 50	Alle	800110	99,-	124,-
Runner-SP LC 50	Alle	800110	99,-	124,-
SMT 50	>06	800109	99,-	124,-
SMT 50	07>	800135	99,-	124,-
Stalker 50	Alle	800111	99,-	124,-
Storm 50	Alle	800111	99,-	124,-
Typhoon 50	Alle	800111	99,-	124,-
Typhoon-X 50	Alle	800111	99,-	124,-
HONDA				
MB/MT 50	Alle	800112	99,-	124,-
SFX 50	Alle	800113	99,-	124,-
Sky 50	Alle	800113	99,-	124,-
Vision Met In 50	Alle	800114	99,-	124,-
Vision SA 50	Alle	800114	99,-	124,-
Wallaroo 50	Alle	800115	99,-	124,-
X8R-S 50	Alle	800116	99,-	124,-
HOOPER				
One 50 (4 t.)	Alle	800134	99,-	124,-
HYOSUNG				
SB 50 M (Cab)	Alle	800106	99,-	124,-
SF 50 B (Racing)	Alle	800106	99,-	124,-
SF 50 R (Rally)	Alle	800106	99,-	124,-
ITALJET				
Formula 50	Alle	800106	99,-	124,-
Velocifero 50	Alle	800106	99,-	124,-
KEEWAY				
F-act 50	Alle	800133	99,-	124,-

M/ÆRKE/MODEL	ÅRG.	Varenr.		
MÄRKE/MODELL	ÅRG.	Art.NR.	DKK	SEK
KEEWAY				
Flash 50	Alle	800133	99,-	124:-
Focus 50	Alle	800133	99,-	124:-
Matrix X 50	Alle	800133	99,-	124:-

KYMCO				
Agility 50 (4 t.)	Alle	800134	99,-	124:-
Fever ZX 50	Alle	800117	99,-	124:-
K-12 50	Alle	800117	99,-	124:-
NZ-50 Super Fever	Alle	800117	99,-	124:-
People 50	Alle	800117	99,-	124:-
Super 8 50 (4 t.)	Alle	800134	99,-	124:-
Super 9 50	Alle	800117	99,-	124:-

KREIDLER				
Easy Rider 50	Alle	800105	99,-	124:-

MALAGUTI				
F10 AC 50	Alle	800105	99,-	124:-
F12 Phantom AC 50	Alle	800105	99,-	124:-
F15 Firefox LC 50	Alle	800103	99,-	124:-

PEUGEOT				
Buxy 50	Alle	800118	99,-	124:-
Elyseo 50	Alle	800118	99,-	124:-
Elystar 50	Alle	800118	99,-	124:-
Fox 50	Alle	800118	99,-	124:-
Looxor 50	Alle	800118	99,-	124:-
Ludix AC 50	Alle	800137	229,-	286:-
Speedake 50	Alle	800118	99,-	124:-
Speedfight AC 50	Alle	800118	99,-	124:-
Speedfight 3 AC 50	Alle	800137	229,-	286:-
Speedfight LC 50	Alle	800119	99,-	124:-
Squab 50	Alle	800118	99,-	124:-
TKR 50	Alle	800118	99,-	124:-
Trekker 50	Alle	800118	99,-	124:-
Trekker/Metal X 50	Alle	800118	99,-	124:-
V-Clic 50 (4 t.)	Alle	800134	99,-	124:-
Vivacity 50	Alle	800118	99,-	124:-
Vivacity AC 50	Alle	800137	229,-	286:-
Zenith 50	Alle	800118	99,-	124:-

PEXMA				
KDQT 50 (4 t.)	Alle	800134	99,-	124:-

PGO				
Big Max 50	Alle	800120	99,-	124:-
Black Magic 50	Alle	800120	99,-	124:-
Bubu 50	Alle	800120	99,-	124:-
Comet 50	Alle	800121	99,-	124:-
Dr. Big 50	Alle	800120	99,-	124:-
Galaxy 50	Alle	800120	99,-	124:-
G-Max 50	Alle	800120	99,-	124:-
Hot-50	Alle	800120	99,-	124:-
Ligero 50	Alle	800120	99,-	124:-
PMS 50	Alle	800120	99,-	124:-
PMX 50	Alle	800120	99,-	124:-
Streetfighter 50	Alle	800120	99,-	124:-
T-Rex 50	Alle	800120	99,-	124:-
Tornado 50	Alle	800120	99,-	124:-

PIAGGIO/VESPA				
ET2 50	Alle	800111	99,-	124:-
Fly 50	Alle	800111	99,-	124:-
Free 50	Alle	800111	99,-	124:-
Liberty 50	Alle	800111	99,-	124:-
NRG Extreme MC3 AC 50	Alle	800111	99,-	124:-
NRG Extreme MC3 LC 50	Alle	800110	99,-	124:-
NRG MC-2 LC 50	Alle	800110	99,-	124:-
Typhoon 50	Alle	800111	99,-	124:-
Typhoon-X 50	Alle	800111	99,-	124:-
Zip 2000 50	Alle	800111	99,-	124:-
Zip 50	Alle	800111	99,-	124:-
Zip 50 (4 t.)	Alle	800136	229,-	286:-

PUCH				
MAXI 50 K		800129	99,-	124:-

RIEJU				
Alle modeller (m. AM-6 motor)	Alle	800104	99,-	124:-

SANELI				
Bahne 50 (4 t.)	Alle	800134	99,-	124:-

M/ÆRKE/MODEL	ÅRG.	Varenr.		
MÄRKE/MODELL	ÅRG.	Art.NR.	DKK	SEK
STRANGER				
X-fight 50 (4 t.)	Alle	800134	99,-	124:-

SYM				
Fancy 50	Alle	800132	99,-	124:-
Jet 50	Alle	800131	99,-	124:-

SUZUKI				
Adress AP-50	Alle	800106	99,-	124:-
DM 50 Samurai	Alle	800130	99,-	124:-
Estilete UF-50	Alle	800123	99,-	124:-
FZ-50	Alle	800124	99,-	124:-
Katana AY-50 AC	Alle	800123	99,-	124:-
Katana AY-50 Alstare	Alle	800107	99,-	124:-
Katana AY-50 LC	Alle	800107	99,-	124:-
RMX 50	Alle	800125	99,-	124:-
SMX 50	Alle	800125	99,-	124:-
TS-50	Alle	800126	99,-	124:-
Zillion LC UX-50	Alle	800107	99,-	124:-

TEXAS				
Chili 50 (4 t.)	Alle	800134	99,-	124:-
City 50 (4 t.)	Alle	800134	99,-	124:-
Flash 50 (4 t.)	Alle	800134	99,-	124:-
Free 50 (4 t.)	Alle	800134	99,-	124:-

TGB				
303/309 50	Alle	800106	99,-	124:-
Akros 50	Alle	800106	99,-	124:-

TMP				
Baboon 50	Alle	800108	99,-	124:-
Gazelle 50	Alle	800108	99,-	124:-

TMS				
Retro 50 (4 t.)	Alle	800134	99,-	124:-
S3 50 (4 t.)	Alle	800134	99,-	124:-
Z2 50 (4 t.)	Alle	800134	99,-	124:-

TOBILINER				
QT 50 (4 t.)	Alle	800134	99,-	124:-

YAMAHA				
Aerox 50	Alle	800103	99,-	124:-
Aerox R 50	Alle	800103	99,-	124:-
ATV 50 cc	Alle	800108	99,-	124:-
Axis 50	Alle	800108	99,-	124:-
Bump 50	Alle	800102	99,-	124:-
BW's 50	Alle	800102	99,-	124:-
BW's N.G. 50	Alle	800102	99,-	124:-
DT-50LC (AM-6)	Alle	800104	99,-	124:-
DT-50R (AM-6)	Alle	800104	99,-	124:-
FS1 K/DX 50	Alle	800127	99,-	124:-
Jog Artistic / Fine Selection 50	Alle	800108	99,-	124:-
Jog Space Innovation 50	Alle	800108	99,-	124:-
Jog-R AC 50	Alle	800105	99,-	124:-
Jog-RR LC 50	Alle	800103	99,-	124:-
MT 50	Alle	800128	99,-	124:-
Neo's 50	Alle	800105	99,-	124:-
Slider 50	Alle	800102	99,-	124:-
Spy 50	Alle	800102	99,-	124:-
TZR 50	Alle	800104	99,-	124:-
Why 50	Alle	800105	99,-	124:-

YIYING				
Stranger 50 (4 t.)	Alle	800134	99,-	124:-



CENTAURO

MÆRKE/MODEL	ÅRG.	Varenr.	DKK	SEK
MÆRKE/MODELL	ÅRG.	Art.NR.	DKK	SEK
APRILIA				
Amico 50	Alle	011900	139,-	174,-
Area 51 LC	Alle	011902	160,-	200,-
Classic 50	Alle	011905	232,-	200,-
Gulliver AC 50	Alle	011901	152,-	190,-
Habana AC (Morini) 50	Alle	011916	242,-	303,-
MX 50	Alle	011905	232,-	200,-
Rally AC 50	Alle	011901	152,-	190,-
RS-50	Alle	011905	232,-	290,-
RX-50	Alle	011905	232,-	290,-
Scarabeo AC 50	Alle	011901	152,-	190,-
Scarabeo Ditech (Morini) 50	Alle	011924	164,-	205,-
Sonic AC 50	Alle	011903	99,-	124,-
Sonic LC 50	Alle	011902	160,-	200,-
SR 50 AC - lodret	Alle	011900	139,-	174,-
SR - Ditech (Morini) 50	Alle	011924	164,-	205,-
SR - www AC 50	Alle	011901	152,-	190,-
SR-Racing, Stealth, Netscaper LC	Alle	011902	160,-	200,-
SR-Replica LC (Minarelli) 50	Alle	011902	160,-	200,-
SR-Replica-2000 LC (Morini) 50	Alle	011924	164,-	200,-
SX 50	07>			
ATALA				
Carosello 50	Alle	011901	152,-	190,-
Hacker AT-12 50	Alle	011909	99,-	124,-
Hacker LC 50	Alle	011924	164,-	205,-
Skeggia 50	Alle	011909	99,-	124,-
BENELLI				
491 GT 50	Alle	011901	152,-	190,-
491 Sport 50	Alle	011901	152,-	190,-
K2/LC 50	Alle	011902	160,-	200,-
BETA				
Ark AC 50	Alle	011901	152,-	190,-
Ark/LC 50	Alle	011902	160,-	200,-
CAGIVA				
City 50	Alle	011907	232,-	290,-
DERBI				
GP-1 50				
GPR 50	Alle	011908	99,-	124,-
Senda R 50	>06	011908	99,-	124,-
Senda SM X-treme 50	07>			
Vamos (Morini) 50	Alle	011909	99,-	124,-
FALCON				
Big Wheel 50	Alle	011901	152,-	190,-
Star-50	Alle	011901	152,-	190,-
GILERA				
DNA LC 50	Alle	011919	139,-	174,-
RCR Off-road 50	Alle	011908	99,-	124,-
Runner LC 50	Alle	011919	139,-	174,-
GILERA				
Runner-SP LC 50	Alle	011919	139,-	174,-
SMT Motard 50	>06	011908	99,-	124,-

MÆRKE/MODEL	ÅRG.	Varenr.	DKK	SEK
MÆRKE/MODELL	ÅRG.	Art.NR.	DKK	SEK
HONDA				
SFX 50	Alle	011911	369,-	461,-
Sky 50	Alle	011911	369,-	461,-
Vision Met In 50	Alle	011910	180,-	225,-
Vision SA 50	Alle	011910	180,-	225,-
HYOSUNG				
SB 50 M (Cab)	Alle	011909	99,-	124,-
SF 50 B (Racing)	Alle	011909	99,-	124,-
SF 50 R (Rally)	Alle	011909	99,-	124,-
ITALJET				
Formula 50	Alle	011909	99,-	124,-
Velocifero 50	Alle	011909	99,-	124,-
KREIDLER				
Easy Rider 50	Alle	011901	152,-	190,-
MALAGUTI				
F10 AC 50	Alle	011901	152,-	190,-
F12 Phantom AC 50	Alle	011901	152,-	190,-
F15 Firefox LC 50	Alle	011902	160,-	200,-
PEUGEOT				
Buxy 50	Alle	011912	157,-	196,-
Elyseo 50	Alle	011914	149,-	186,-
Looxor 50	Alle	011914	149,-	186,-
Speedake 50	Alle	011912	157,-	186,-
Speedfight AC 50	Alle	011914	149,-	186,-
Speedfight LC 50	Alle	011925	283,-	354,-
Squab 50	Alle	011912	157,-	196,-
TKR 50	Alle	011914	149,-	186,-
Trekker 50	Alle	011914	149,-	186,-
Trekker/Metal X 50	Alle	011914	149,-	186,-
Vivacity 50	Alle	011914	149,-	186,-
Zenith 50	Alle	011913	252,-	315,-
PGO				
Big Max 50	Alle	011915	335,-	419,-
Black Magic 50	Alle	011915	335,-	419,-
Bubu 50	Alle	011915	335,-	419,-
Comet 50	Alle	011927	283,-	354,-
Dr. Big 50	Alle	011915	335,-	419,-
Galaxy 50	Alle	011915	335,-	419,-
G-Max 50	Alle	011915	335,-	419,-
Hot-50	Alle	011915	335,-	419,-
Ligero 50	Alle	011915	335,-	419,-
PMS 50	Alle	011915	335,-	419,-
PMX 50	Alle	011915	335,-	419,-
Rodoshow 50	Alle	011915	335,-	419,-
Streetfighter 50	Alle	011915	335,-	419,-
T-Rex 50	Alle	011915	335,-	419,-
Tornado 50	Alle	011915	335,-	419,-
PIAGGIO/VESPA				
NRG Extreme MC3 LC 50	Alle	011919	139,-	174,-
NRG MC-2 LC 50	Alle	011919	139,-	174,-

PAKNINGSSÆT KOMPLET
KOMPLETTA PACKNINGSSÆT

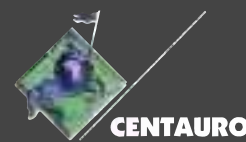

Forhandlere
Återförsäljare
s. 2

Stikord
Sökord
s. 4

Tøj/hjelme
Klæder/
hjelmar
s. 6

Dæk og
slanger
Dæk og
slanger
s. 15

Olje / spray
Olja / spray
s. 26

Kæder /
tandhjul
Kedjor /
drev
s. 43

Bremseleder
Bromsdelar
s. 48

Låse
Lås
s. 93

Batteri
Batteri
s. 96

Cylinder /
topstykke
Cylinder /
toplock
s. 105

Motordele
Motordele
s. 137

Karburator
- Luftfilter
Förgasare
- Luftfilter
s. 208

El-dele
tændrør
Elektriskt
tændstift
s. 222

Udstødning
Avgassystem
s. 246

Forgaffel
Støddæmpere
Framgaffel
Støtdämpare
s. 260

Kabler
Wire
s. 266

Styr og
greb
Styre och
handtag
s. 272

Spejle
Speglar
s. 282

Blinklygter
Baglygter
Blinkers
Baklykte
s. 284

Støtteben
Topboks, mm.
Stödd
Topbbox, mm
s. 291

Rep. bøger
værktøj
Rep. böcker
Verktyg
s. 297

MÆRKE/MODEL	ÅRG.	Varenr.		
MÄRKE/MODELL	ÅRG.	Art.NR.	DKK	SEK
RIEJU				
Alle modeller (m. AM-6 motor)	Alle	011905	232,-	290,-
SUZUKI				
Adress AP-50	Alle	011909	99,-	124,-
Estilite UF-50	Alle	011916	242,-	303,-
Katana AY-50 AC	Alle	011916	242,-	303,-
Katana AY-50 Alstare	Alle	011917	242,-	303,-
Katana AY-50 LC	Alle	011917	242,-	303,-
RMX 50	Alle	011926	164,-	205,-
SMX 50	Alle	011926	164,-	205,-
Zillion LC UX-50	Alle	011917	242,-	303,-
TGB				
303/309 50	Alle	011909	99,-	124,-
Akros 50	Alle	011909	99,-	124,-
TMP				
Baboon 50	Alle	011903	99,-	200,-
Gazelle 50	Alle	011903	99,-	200,-

MÆRKE/MODEL	ÅRG.	Varenr.		
MÄRKE/MODELL	ÅRG.	Art.NR.	DKK	SEK
YAMAHA				
Aerox 50	Alle	011902	160,-	200,-
Aerox R 50	Alle	011902	160,-	200,-
Axis 50	Alle	011903	99,-	200,-
Bump 50	Alle	011900	139,-	174,-
BW's 50	Alle	011900	139,-	174,-
BW's N.G. 50	Alle	011900	139,-	174,-
DT-50LC (AM-6)	Alle	011905	232,-	290,-
DT-50R (AM-6)	Alle	011905	232,-	290,-
Jog Artistic / Fine Selection 50	Alle	011903	99,-	124,-
Jog Space Innovation 50	Alle	011903	99,-	124,-
Jog-R AC 50	Alle	011901	152,-	190,-
Jog-RR LC 50	Alle	011902	160,-	200,-
Neo's 50	Alle	011901	152,-	190,-
Slider 50	Alle	011900	139,-	174,-
Spy 50	Alle	011900	139,-	174,-
TZR 50	Alle	011905	232,-	290,-
Why 50	Alle	011901	152,-	190,-



MOTORDÆKSEL PAKNING (10 stk)
PACKNING MOTORKÅPA (10 st)

MÆRKE/MODEL	ÅRG.	Varenr.		
MÄRKE/MODELL	ÅRG.	Art.NR.	DKK	SEK
ADLY				
Cat 50	Alle	800300	20,-	25,-
Jet 50	Alle	800300	20,-	25,-
Silver Fox 50	Alle	800300	20,-	25,-
Super Sonic 50	Alle	800300	20,-	25,-
Thunder Bike 50	Alle	800300	20,-	25,-
APRILIA				
Amico 50	Alle	800301	20,-	25,-
Area 51 LC 50	Alle	800302	20,-	25,-
Gulliver 50	Alle	800302	20,-	25,-
Rally AC 50	Alle	800302	20,-	25,-
Scarabeo 50	Alle	800302	20,-	25,-
Scarabeo Ditech (Morini) 50	Alle	800304	20,-	25,-
Sonic AC 50	Alle	800305	20,-	25,-
Sonic LC 50	Alle	800302	20,-	25,-
SR - Ditech (Morini) 50	Alle	800304	20,-	25,-
SR - www AC 50	Alle	800302	20,-	25,-
SR-50 AC 50	Alle	800302	20,-	25,-
SR-Racing 50, Stealth, Netscaper LC	Alle	800302	20,-	25,-
SR-Replica LC (Minarelli) 50	Alle	800302	20,-	25,-
SR-Replica-2000 LC (Morini) 50	Alle	800304	20,-	25,-
ATALA				
Carosello 50	Alle	800302	20,-	25,-
Hacker AT-12 50	Alle	800303	20,-	25,-
Hacker LC 50	Alle	800304	20,-	25,-
Skeggia 50	Alle	800303	20,-	25,-
BENELLI				
491 GT 50	Alle	800302	20,-	25,-
491 Sport 50	Alle	800302	20,-	25,-
K2/LC 50	Alle	800302	20,-	25,-

MÆRKE/MODEL	ÅRG.	Varenr.		
MÄRKE/MODELL	ÅRG.	Art.NR.	DKK	SEK
BETA				
Ark AC 50	Alle	800302	20,-	25,-
Ark LC 50	Alle	800302	20,-	25,-
CPI				
Aragon 50 (Euro 2)	Alle	800305	20,-	25,-
ATV 50 cc		800305	20,-	25,-
Formula R 50 (Euro 2)	Alle	800305	20,-	25,-
Hussar 50	Alle	800305	20,-	25,-
Oliver/City 50 (Euro 2)	Alle	800305	20,-	25,-
Popcorn 50	Alle	800305	20,-	25,-
DERBI				
Vamos (Morini) 50		800303	20,-	25,-
FALCON				
Big Wheel 50	Alle	800302	20,-	25,-
Star-50	Alle	800302	20,-	25,-
GENERIC				
Ideo 50	Alle	800305	20,-	25,-
Race 50	Alle	800305	20,-	25,-
Xor 50	Alle	800305	20,-	25,-
HONDA				
SFX 50	Alle	800306	20,-	25,-
Sky 50	Alle	800306	20,-	25,-
HYOSUNG				
SB 50 M (Cab)	Alle	800303	20,-	25,-
SF 50 B (Racing)	Alle	800303	20,-	25,-
SF 50 R (Rally)	Alle	800303	20,-	25,-

Forsettet næste side ...
Fortsättning på nästa sida ...

MÆRKE/MODEL	ÅRG.	Varenr.		
MÆRKE/MODELL	ÅRG.	Art.NR.	DKK	SEK
ITALJET				
Formula 50	Alle	800303	20,-	25,-
Velocifero 50	Alle	800303	20,-	25,-
KEEWAY				
F-act 50	Alle	800305	20,-	25,-
Flash 50	Alle	800305	20,-	25,-
Focus 50	Alle	800305	20,-	25,-
Matrix 50	Alle	800305	20,-	25,-
KREIDLER				
Easy Rider 50	Alle	800302	20,-	25,-
MALAGUTI				
F10 AC 50	Alle	800302	20,-	25,-
F12 Phantom AC 50	Alle	800302	20,-	25,-
F15 Firefox LC 50	Alle	800302	20,-	25,-
PGO				
Big Max 50	Alle	800311	20,-	25,-
Black Magic 50	Alle	800311	20,-	25,-
Bubu 50	Alle	800311	20,-	25,-
Dr. Big 50	Alle	800311	20,-	25,-
Galaxy 50	Alle	800311	20,-	25,-
G-Max 50	Alle	800311	20,-	25,-
Hot 50	Alle	800311	20,-	25,-
Ligero 50	Alle	800311	20,-	25,-
PMS 50	Alle	800311	20,-	25,-
PMX 50	Alle	800311	20,-	25,-
Rodoshow 50	Alle	800311	20,-	25,-
Streetfighter 50	Alle	800311	20,-	25,-
T-Rex 50	Alle	800311	20,-	25,-
Tornado 50	Alle	800311	20,-	25,-
SUZUKI				
Adress AP-50	Alle	800303	20,-	25,-
FZ 50	Alle	800309	20,-	25,-
Estilte UF-50	Alle	800303	20,-	25,-

MÆRKE/MODEL	ÅRG.	Varenr.		
MÆRKE/MODELL	ÅRG.	Art.NR.	DKK	SEK
SUZUKI ...fortsat				
Katana AY-50 AC	Alle	800303	20,-	25,-
Katana AY-50 LC Alstare	Alle	800304	20,-	25,-
Katana AY-50 LC	Alle	800304	20,-	25,-
RMX 50 (Koblingsdækselpakn.)	Alle	800307	20,-	25,-
SMX 50 (Koblingsdækselpakn.)	Alle	800307	20,-	25,-
Street Magic 50	Alle	800308	20,-	25,-
Zillion LC 50	Alle	800304	20,-	25,-
SYM 50				
Jet 50	Alle	800310	20,-	25,-
TGB/TOBI				
303/309 50	Alle	800303	20,-	25,-
Akros 50	Alle	800303	20,-	25,-
TMP				
Baboon 50	Alle	800305	20,-	25,-
Gazelle 50	Alle	800305	20,-	25,-
YAMAHA				
Aerox 50	Alle	800302	20,-	25,-
ATV 50 cc	Alle	800305	20,-	25,-
Axis 50	Alle	800305	20,-	25,-
Bump 50	Alle	800301	20,-	25,-
BW's 50	Alle	800301	20,-	25,-
BW's N.G. 50	Alle	800301	20,-	25,-
Jog Artistic - Fine Selection 50	Alle	800305	20,-	25,-
Jog Space Innovacion 50	Alle	800305	20,-	25,-
Jog-R 50	Alle	800302	20,-	25,-
Jog-RR 50	Alle	800302	20,-	25,-
Neo's 50	Alle	800302	20,-	25,-
Slider 50	Alle	800302	20,-	25,-
Spy 50	Alle	800302	20,-	25,-
Why 50	Alle	800302	20,-	25,-

MAX
MC Parts

MOTORPAKDÅSE SÆT
PACKBOXMOTOR

MÆRKE/MODEL	ÅRG.	Varenr.		
MÆRKE/MODELL	ÅRG.	Art.NR.	DKK	SEK
ADLY				
Cat 50	Alle	800350	85,-	106,-
Jet 50	Alle	800351	85,-	106,-
Silver Fox 50	Alle	800350	85,-	106,-
Super Sonic 50	Alle	800351	85,-	106,-
Super Sonic 50	Alle	800351	85,-	106,-
Thunder Bike 50	Alle	800351	85,-	106,-
APRILIA				
Amico 50	Alle	800350	85,-	106,-
Area 51LC 50	98->	800351	85,-	106,-
Gulliver 50	Alle	800351	85,-	106,-
Habana AC (Morini) 50	Alle	800352	85,-	106,-
Rally AC 50	->96	800351	85,-	106,-
Sonic AC 50	98->	800351	85,-	106,-
Sonic LC	Alle	800351	85,-	106,-
SR - www AC 50	97->	800351	85,-	106,-
SR-50 AC	->96	800351	85,-	106,-
SR-50 AC	->93	800350	85,-	106,-
SR-Racing, Stealth, Netscaper LC	Alle	800351	85,-	106,-
SR-Replica LC (Minarelli) 50	->00	800351	85,-	106,-
SX 50	07>			
ATALA				
Carosello 50	Alle	800351	85,-	106,-
Hacker AT-12 50	Alle	800352	85,-	106,-
Hacker LC 50	Alle	800352	85,-	106,-
Skeggia 50	Alle	800352	85,-	106,-
AVANTI				
9 N 50 (4 t.)	Alle	800359	78,-	98,-
Sport Classic 50 (4 t.)	Alle	800359	78,-	98,-

MÆRKE/MODEL	ÅRG.	Varenr.		
MÆRKE/MODELL	ÅRG.	Art.NR.	DKK	SEK
AVANTI				
Eagle 50 (4 t.)	Alle	800359	78,-	98,-
Avanti Wolf 50 (4 t.)	Alle	800359	78,-	98,-
BAOTAIN				
BT49QT-7 50 (4 t.)	Alle	800359	78,-	98,-
BT49QT-9 50 (4 t.)	Alle	800359	78,-	98,-
BT49QT-11 50 (4 t.)	Alle	800359	78,-	98,-
BT49QT-12C 50 (4 t.)	Alle	800359	78,-	98,-
BT49QT-12 50 (4 t.)	Alle	800359	78,-	98,-
BENDA				
Scoot 50 (4 t.)	Alle	800359	78,-	98,-
BENELLI				
491 GT 50	97->	800351	85,-	106,-
491 Sport 50	97->	800351	85,-	106,-
K2/LC 50	->96	800351	85,-	106,-
K2/LC 50	96->	800351	85,-	85,-
BETA				
Ark AC 50	Alle	800351	85,-	106,-
Ark LC 50	Alle	800351	85,-	106,-
CPI				
Aragon 50 (Euro 2)	Alle	800353	85,-	106,-
ATV 50 cc		800353	85,-	106,-
Formula R 50 (Euro 2)	Alle	800353	85,-	106,-
Hussar 50	Alle	800353	85,-	106,-
Oliver/City 50 (Euro 2)	Alle	800353	85,-	106,-
Popcorn 50	Alle	800353	85,-	106,-

MÆRKE/MODEL	ÅRG.	Varenr.		
MÄRKE/MODELL	ÅRG.	Art.NR.	DKK	SEK
DERBI				
Vamos (Morini) 50		800352	85,-	106,-
FYM				
QT 50 (4 t.)	Alle	800359	78,-	98,-
GENERIC				
Ideo 50	Alle	800353	85,-	106,-
Race 50	Alle	800353	85,-	106,-
Xor 50	Alle	800353	85,-	106,-
GIANTCO				
G-Buddy 50 (4 t.)	Alle	800359	78,-	98,-
Sprint 50 (4 t.)	Alle	800359	78,-	98,-
Stealth 50 (4 t.)	Alle	800359	78,-	98,-
Venus 50 (4 t.)	Alle	800359	78,-	98,-
GILERA				
DNA LC 50	Alle	800354	85,-	106,-
ICE AC 50	Alle	800354	85,-	106,-
RCR Off-road 50	Alle			
Runner LC 50	Alle	800354	85,-	106,-
Runner PJ 50	03->	800354	85,-	106,-
Runner SP LC 50	02->	800354	85,-	106,-
SMT Motard 50	Alle			
Stalker 50	Alle	800354	85,-	106,-
Storm 50				
Typhoon 50	->01	800354	85,-	106,-
Typhoon-X 50	02->	800354	85,-	106,-
HONDA				
Vision 50	Alle	800355	85,-	106,-
Vision Met-In 50	Alle	800355	85,-	106,-
HOOPER				
One 50 (4 t.)	Alle	800359	78,-	98,-
ITALJET				
Formula 50	Alle	800352	85,-	106,-
Velocifero 50	Alle	800352	85,-	106,-
KEEWAY				
F-act 50	Alle	800353	85,-	106,-
Flash 50	Alle	800353	85,-	106,-
Focus 50	Alle	800353	85,-	106,-
Matrix 50	Alle	800353	85,-	106,-
KREIDLER				
Easy Rider 50	Alle	800351	85,-	106,-
KYMCO				
Agility 50 (4 t.)	Alle	800359	78,-	98,-
Super 8 50 (4 t.)	Alle	800359	78,-	98,-
MALAGUTI				
F10 AC 50	Alle	800351	85,-	106,-
F12 Phantom AC 50	Alle	800351	85,-	106,-
F15 Firefox LC 50	Alle	800351	85,-	106,-
PEUGEOT				
Buxy 50	94->	800356	85,-	106,-
Elyseo 50	98->	800356	85,-	106,-
Elystar 50	Alle	800356	85,-	106,-
Fox 25 50	03->	800356	85,-	106,-
Looxor 50	Alle	800356	85,-	106,-
Speedake 50	95->	800356	85,-	106,-
Speedfight AC 50	Alle	800356	85,-	106,-
Speedfight LC 50	Alle	800356	85,-	106,-
Squab 50	95->	800356	85,-	106,-
TKR 50	Alle	800356	85,-	106,-
Trekker 50	98->	800356	85,-	106,-
Trekker/Metal X 50	03->	800356	85,-	106,-
V-Clic 50 (4 t.)	Alle	800359	78,-	98,-
Vivacity 50	Alle	800356	85,-	106,-
Zenith 50	94->	800356	85,-	106,-
PEXMA				
KDQT 50 (4 t.)	Alle	800359	78,-	98,-
PGO				
Comet 50	Alle	800357	85,-	106,-
Black Magic 50	Alle	800357	85,-	106,-
Bubu 50	Alle	800357	85,-	106,-
Dr. Big 50	Alle	800357	85,-	106,-

MÆRKE/MODEL	ÅRG.	Varenr.		
MÄRKE/MODELL	ÅRG.	Art.NR.	DKK	SEK
PGO				
Galaxy 50	Alle	800357	85,-	106,-
G-Max 50	Alle	800357	85,-	106,-
Hot-50	Alle	800357	85,-	106,-
Ligero 50	Alle	800357	85,-	106,-
PMS 50	Alle	800357	85,-	106,-
PMX 50	Alle	800357	85,-	106,-
Rodoshow 50	Alle	800357	85,-	106,-
Streetfighter 50	Alle	800357	85,-	106,-
T-Rex 50	Alle	800357	85,-	106,-
Tornado 50	Alle	800357	85,-	106,-
PIAGGIO/VESPA				
ET2 50	97->	800354	85,-	106,-
Fly 50	Alle	800354	85,-	106,-
Free 50	Alle	800354	85,-	106,-
Liberty 50	Alle	800354	85,-	106,-
NRG Extreme MC3 AC 50	03->	800354	85,-	106,-
NRG Extreme MC3 LC 50	01->	800354	85,-	106,-
NRG MC-2 LC 50	94->	800354	85,-	106,-
Typhoon 50	Alle	800354	85,-	106,-
Typhoon-X 50	02->	800354	85,-	106,-
Zip 2000 50	00->	800354	85,-	106,-
Zip 50	93->	800354	85,-	106,-
Zip 50 4-Takt	00->	800354	85,-	106,-
SANELI				
Bahne 50 (4 t.)	Alle	800359	78,-	98,-
STRANGER				
X-fight 50 (4 t.)	Alle	800359	78,-	98,-
SUZUKI				
Adress AP-50	Alle	800352	85,-	106,-
Estilite, UF-50	Alle	800352	85,-	106,-
Katana AY-50 AC	Alle	800352	85,-	106,-
Katana AY-50 LC	Alle	800352	85,-	106,-
Katana AY-50 LC Alstare	Alle	800352	85,-	106,-
Zillion LC, UX-50	Alle	800352	85,-	106,-
FZ 50	Alle	800358	85,-	106,-
TEXAS				
Chilli 50 (4 t.)	Alle	800359	78,-	98,-
City 50 (4 t.)	Alle	800359	78,-	98,-
Flash 50 (4 t.)	Alle	800359	78,-	98,-
Free 50 (4 t.)	Alle	800359	78,-	98,-
TGB/TOBI				
303/309 50	Alle	800352	85,-	106,-
Akros 50	Alle	800352	85,-	106,-
TMP				
Baboon 50	Alle	800351	85,-	106,-
Gazelle 50	Alle	800351	85,-	106,-
TMS				
Retro 50 (4 t.)	Alle	800359	78,-	98,-
S3 50 (4 t.)	Alle	800359	78,-	98,-
Z2 50 (4 t.)	Alle	800359	78,-	98,-
TOBILINER				
QT 50 (4 t.)	Alle	800359	78,-	98,-
YAMAHA				
Aerox, AN-50	97->	800351	85,-	106,-
Aerox-R, AN-50	03->	800351	85,-	106,-
Axis 50	95->	800351	85,-	106,-
Bump 50	97->	800350	85,-	106,-
BW's 50	Alle	800350	85,-	106,-
BW's N.G. 50	Alle	800350	85,-	106,-
Jog Artistic -Fine Selection 50	Alle	800351	85,-	106,-
Jog Space Innovation 50	98->	800351	85,-	106,-
Jog-R AC 50	03->	800351	85,-	106,-
Jog-RR LC 50	03->	800351	85,-	106,-
Neo's 50	Alle	800351	85,-	106,-
Slider 50	01->	800350	85,-	106,-
Spy 50	Alle	800350	85,-	106,-
Why 50	99->	800351	85,-	106,-
YIYING				
Stranger 50 (4 t.)	Alle	800359	78,-	98,-

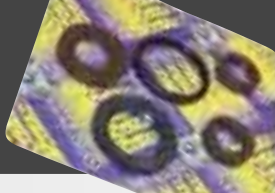

MÆRKE/MODEL	ÅRG.	Varenr.	DKK	SEK
MÆRKE/MODELL	ÅRG.	Art.NR.	DKK	SEK
ADLY				
Cat 50	Alle	015400	155,-	194,-
Jet 50	Alle	015400	155,-	194,-
Silver Fox 50	Alle	015400	155,-	194,-
Super Sonic 50	Alle	015400	155,-	194,-
Thunder Bike 50	Alle	015400	155,-	194,-
APRILIA				
Amico 50	Alle	015400	155,-	194,-
Area 51 LC 50	Alle	015401	165,-	206,-
Classic 50	Alle	015402	195,-	206,-
Gulliver AC 50	Alle	015400	155,-	194,-
Habana AC (Morini) 50	Alle	015414	255,-	319,-
MX 50	Alle	015402	195,-	206,-
Rally AC 50	Alle	015400	155,-	194,-
RS-50	Alle	015402	195,-	244,-
RX-50	Alle	015402	195,-	244,-
Scarabeo AC 50	Alle	015400	155,-	194,-
Scarabeo Ditech (Morini) 50	Alle	015410	198,-	248,-
Sonic AC 50	Alle	015400	155,-	194,-
Sonic LC 50	Alle	015401	165,-	206,-
SR 50 AC	Alle	015400	155,-	194,-
SR - Ditech (Morini) 50	Alle	015410	198,-	248,-
SR - www AC 50	Alle	015400	155,-	194,-
SR-Racing 50, Stealth, Netscaper LC	Alle	015401	165,-	206,-
SR-Replica LC (Minarelli) 50	Alle	015401	165,-	206,-
SR-Replica-2000 LC (Morini) 50	Alle	015410	198,-	248,-
SX 50	07>	015415	235,-	294,-
ATALA				
Carosello 50	Alle	015400	155,-	194,-
Hacker AT-12 50	Alle	015405	155,-	194,-
Hacker LC 50	Alle	015405	155,-	194,-
Skeggia 50	Alle	015405	155,-	194,-
BENELLI				
491 GT 50	Alle	015400	155,-	194,-
491 Sport 50	Alle	015400	155,-	194,-
K2/LC 50	Alle	015401	165,-	206,-
BETA				
Ark AC 50	Alle	015400	155,-	194,-
Ark/LC 50	Alle	015401	165,-	206,-
Enduro RR 50	93->	015403	275,-	344,-
Super Motard 50	99->	015403	275,-	344,-
CAGIVA				
City 50	Alle	015404	175,-	219,-
Mito 50	Alle	015402	195,-	244,-
CPI				
Aragon 50	Alle	015417	198,-	248,-
Formula R 50	Alle	015417	198,-	248,-
Hussar 50	Alle	015417	198,-	248,-
Oliver/City 50	Alle	015417	198,-	248,-
Popcorn 50	Alle	015417	198,-	248,-
DERBI				
GPR 50	Alle	015415	235,-	294,-
Senda R 50	Alle	015415	235,-	294,-
Senda SM X-treme 50	Alle	015415	235,-	294,-
Vamos (Morini) 50	Alle	015405	155,-	194,-
GENERIC				
Ideo 50	Alle	015417	198,-	248,-
XOR 2 50	Alle	015417	198,-	248,-
Race 50	Alle	015417	198,-	248,-
Trigger SM 50	Alle	015402	195,-	244,-
Trigger X 50	Alle	015402	195,-	244,-
GILERA				
DNA LC 50	Alle	015413	315,-	394,-
ICE AC 50	Alle	015412	369,-	461,-
RCR Off-road 50	Alle	015415	235,-	294,-
Runner AC 50	Alle	015412	369,-	461,-
Runner LC 50	Alle	015413	315,-	394,-
Runner-SP LC 50	Alle	015413	315,-	394,-
SMT Motard 50	Alle	015415	235,-	294,-
Stalker 50	Alle	015412	369,-	461,-
Storm 50	Alle	015412	369,-	461,-
Typhoon 50	Alle	015412	369,-	461,-
Typhoon-X 50	Alle	015412	369,-	461,-

MÆRKE/MODEL	ÅRG.	Varenr.	DKK	SEK
MÆRKE/MODELL	ÅRG.	Art.NR.	DKK	SEK
HONDA				
SFX 50	Alle	015407	92,-	115,-
Sky 50	Alle	015407	92,-	115,-
Vision Met In 50	Alle	015406	95,-	119,-
Vision SA 50	Alle	015406	95,-	119,-
X8R-S 50	Alle	015416	99,-	124,-
ITALJET				
Formula 50	Alle	015405	155,-	194,-
Velocifero 50	Alle	015405	155,-	194,-
KEEWAY				
Flash 50	Alle	015417	198,-	248,-
Focus 50	Alle	015417	198,-	248,-
Matrix 50	Alle	015417	198,-	248,-
Hurricane 50	Alle	015417	198,-	248,-
F-act 50	Alle	015417	198,-	248,-
KREIDLER				
Easy Rider 50	Alle	015400	155,-	194,-
MALAGUTI				
F10 AC 50	Alle	015400	155,-	194,-
F12 Phantom AC 50	Alle	015400	155,-	194,-
MALAGUTI				
F15 Firefox LC 50	Alle	015401	165,-	206,-
PEUGEOT				
Buxy 50	Alle	015408	115,-	144,-
Elyseo 50	Alle	015408	115,-	144,-
Elystar 50	Alle	015408	115,-	144,-
Fox 50	Alle	015408	115,-	144,-
Looxor 50	Alle	015408	115,-	144,-
Speedake 50	Alle	015408	115,-	144,-
Speedfight AC 50	Alle	015408	115,-	144,-
Speedfight LC 50	Alle	015408	115,-	144,-
Squab 50	Alle	015408	115,-	144,-
TKR 50	Alle	015408	115,-	144,-
Trekker 50	Alle	015408	115,-	144,-
Trekker/Metal X 50	Alle	015408	115,-	144,-
Vivacity 50	Alle	015408	115,-	144,-
XP S 50	Alle	015402	195,-	244,-
XP 6 50	Alle	015402	195,-	244,-
XR 6 50	Alle	015402	195,-	244,-
Zenith 50	Alle	015408	115,-	144,-
PGO				
Big Max 50	Alle	015409	115,-	144,-
Black Magic 50	Alle	015409	115,-	144,-
Bubu 50	Alle	015409	115,-	144,-
Dr. Big 50	Alle	015409	115,-	144,-
Galaxy 50	Alle	015409	115,-	144,-
Ligero 50	Alle	015409	115,-	144,-
G-Max 50	Alle	015409	115,-	144,-
Hot-50	Alle	015409	115,-	115,-
PMS 50	Alle	015409	115,-	115,-
PMX 50	Alle	015409	115,-	115,-
Rodoshow 50	Alle	015409	115,-	115,-
Streetfighter 50	Alle	015409	115,-	115,-
T-Rex 50	Alle	015409	115,-	115,-
Tornado 50	Alle	015409	115,-	115,-
PIAGGIO/VESPA				
ET2 50	Alle	015411	237,-	296,-
NRG Extreme MC3 AC 50	Alle	015412	369,-	461,-
NRG Extreme MC3 LC 50	Alle	015413	315,-	394,-
NRG MC-2 LC 50	Alle	015413	315,-	394,-
Typhoon 50	Alle	015412	369,-	461,-
Typhoon-X 50	Alle	015412	369,-	461,-
Zip 2000 50	Alle	015412	369,-	461,-
Zip 50	Alle	015411	237,-	296,-
RIEJU				
Alle modeller 50 (m. AM-6 motor)	Alle	015402	195,-	244,-
MRX 50	Alle			
RR/RS 50	Alle			
SMX 50	Alle			
SUZUKI				
Adress AP-50	Alle	015405	155,-	194,-
Estilete UF-50	Alle	015414	255,-	319,-

MOTORPAKDÅSE SÆT
PACKBOXMOTOR

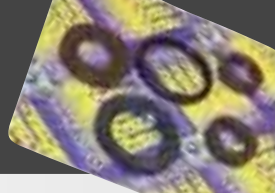

Forhandlere
Återforsjäljare
s. 2

Stikord
Sökord
s. 4

Tøj/hjelme
Kläder/
hjälmår
s. 6

Däck og
slanger
Däck och
slangar
s. 15

Olje / spray
Olja / spray
s. 26

Kæder /
tandhjul
Kedjor /
drev
s. 43

Bremsedele
Bromsdelar
s. 48

Låse
Lås
s. 93

Batteri
Batteri
s. 96

Cylinder /
topstycke
Cylinder /
topplock
s. 105

Motordele
Motordele
s. 137

Karburator
- Luftfilter
Förgasare
- Luftfilter
s. 208

El-dele
tændrør
Elektriskt
tändstift
s. 222

Udstødning
Avgassystem
s. 246

Forgaffel
Støddæmpere
Framgaffel
Støtdämpare
s. 260

Kabler
Wire
s. 266

Styr og
greb
Styre och
handtag
s. 272

Spejle
Speglar
s. 282

Blinklygter
Baglygter
Blinkers
Baklygte
s. 284

Støtteben
Topboks, mm.
Stödd
Toppbox, mm
s. 291

Rep. bøger
værktøj
Rep. böcker
Verktyg
s. 297

MÆRKE/MODEL	ÅRG.	Varenr.		
MÄRKE/MODELL	ÅRG.	Art.NR.	DKK	SEK
SUZUKI				
Katana AY-50 AC	Alle	015410	198,-	248:-
Katana AY-50 Alstare	Alle	015410	198,-	248:-
Katana AY-50 LC	Alle	015410	198,-	248:-
Zillion LC UX-50	Alle	015410	198,-	248:-

TGB				
303/309 50	Alle	015405	155,-	194:-
Akros 50	Alle	015405	155,-	194:-

TMP				
Baboon 50	Alle	015400	155,-	194:-
Gazelle 50	Alle	015400	155,-	194:-

YAMAHA				
Aerox 50	Alle	015401	165,-	206:-
Aerox R 50	Alle	015401	165,-	206:-
Axis 50	Alle	015400	155,-	194:-
Bump 50	Alle	015400	155,-	194:-
BW's 50	Alle	015400	155,-	194:-
BW's N.G. 50	Alle	015400	155,-	194:-

MÆRKE/MODEL	ÅRG.	Varenr.		
MÄRKE/MODELL	ÅRG.	Art.NR.	DKK	SEK
YAMAHA				
DT-50LC (AM-6)	Alle	015402	195,-	244:-
DT-50R (AM-6)	Alle	015402	195,-	244:-
Jog Artistic / Fine Selection 50	Alle	015400	155,-	194:-
Jog Space Innovation 50	Alle	015400	155,-	194:-
Jog-R AC 50	Alle	015400	155,-	194:-
Jog-RR LC 50	Alle	015401	165,-	206:-
Neo's 50	Alle	015400	155,-	194:-
Slider 50	Alle	015400	155,-	194:-
Spy 50	Alle	015400	155,-	194:-
TZR 50	Alle	015402	195,-	244:-
Why 50	Alle	015400	155,-	194:-

MEMBRANPAKNING (10 stk)
MEMBRANPACKNING (10 st)

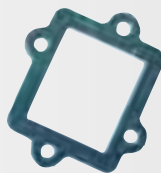

800280

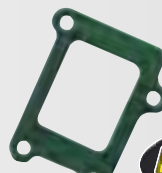

800281



MÆRKE/MODEL	ÅRG.	Varenr.		
MÄRKE/MODELL	ÅRG.	Art.NR.	DKK	SEK
ADLY				
Jet 50	Alle	800280	10,-	13:-
Super Sonic 50	Alle	800280	10,-	13:-
Thunder Bike 50	Alle	800280	10,-	13:-

APRILIA				
Area 51 LC 50	Alle	800280	10,-	13:-
Gulliver AC 50	Alle	800280	10,-	13:-
Rally AC 50	Alle	800280	10,-	13:-
Scarabeo AC 50	Alle	800280	10,-	13:-
Sonic AC 50	Alle	800280	10,-	13:-
Sonic LC 50	Alle	800280	10,-	13:-
SR 50 AC 50	Alle	800280	10,-	13:-
SR - www AC 50	Alle	800280	10,-	13:-
SR-Racing 50, Stealth, Netscaper LC	Alle	800280	10,-	13:-
SR-Replica LC (Minarelli) 50	Alle	800280	10,-	13:-
SR-Replica-2000 LC (Morini) 50	Alle	800280	10,-	13:-

ATALA				
Carosello 50	Alle	800280	10,-	13:-

BENELLI				
491 GT 50	Alle	800280	10,-	13:-
491 Sport 50	Alle	800280	10,-	13:-
K2/LC 50	Alle	800280	10,-	13:-

BETA				
Ark AC 50	Alle	800280	10,-	13:-
Ark/LC 50	Alle	800280	10,-	13:-

CPI				
Aragon 50 (Euro 2)	Alle	800280	10,-	13:-
ATV 50 cc	Alle	800280	10,-	13:-
Formula R (Euro 2)	Alle	800280	10,-	13:-
Hussar 50	Alle	800280	10,-	13:-
Oliver/City 50 (Euro 2)	Alle	800280	10,-	13:-
Popcorn 50	Alle	800280	10,-	13:-

GENERIC				
Ideo 50	Alle	800280	10,-	13:-
Race 50	Alle	800280	10,-	13:-
Xor 50	Alle	800280	10,-	13:-

KEEWAY				
F-act 50	Alle	800280	10,-	13:-
Flash 50	Alle	800280	10,-	13:-
Focus 50	Alle	800280	10,-	13:-
Matrix 50	Alle	800280	10,-	13:-

MÆRKE/MODEL	ÅRG.	Varenr.		
MÄRKE/MODELL	ÅRG.	Art.NR.	DKK	SEK
KREIDLER				
Easy Rider 50	Alle	800280	10,-	13:-
MALAGUTI				
F10 AC 50	Alle	800280	10,-	13:-
F12 Phantom AC 50	Alle	800280	10,-	13:-
F15 Firefox LC 50	Alle	800280	10,-	13:-

PGO				
Big Max 50	Alle	800281	10,-	13:-
Black Magic 50	Alle	800281	10,-	13:-
Bubu 50	Alle	800281	10,-	13:-
Comet 50	Alle	800281	10,-	13:-
Dr. Big 50	Alle	800281	10,-	13:-
Galay 50	Alle	800281	10,-	13:-
G-Max 50	Alle	800281	10,-	13:-
Ligero 50	Alle	800281	10,-	13:-
Hot-50	Alle	800281	10,-	13:-
PMS 50	Alle	800281	10,-	13:-
PMX 50	Alle	800281	10,-	13:-
Rodoshow 50	Alle	800281	10,-	13:-
Streetfighter 50	Alle	800281	10,-	13:-
T-Rex 50	Alle	800281	10,-	13:-
Tornado 50	Alle	800281	10,-	13:-

SUZUKI				
Estilete 50	Alle	800280	10,-	13:-
Katana AY-50 AC	Alle	800280	10,-	13:-
Katana AY-50 Alstare	Alle	800280	10,-	13:-
Katana AY-50 LC	Alle	800280	10,-	13:-
Zillion LC 50	Alle	800280	10,-	13:-

TMP				
Baboon 50	Alle	800280	10,-	13:-
Gazelle 50	Alle	800280	10,-	13:-

YAMAHA				
Aerox 50	Alle	800280	10,-	13:-
ATV 50 cc	Alle	800280	10,-	13:-
Axis 50	Alle	800280	10,-	13:-
Jog Artistic - Fine Selection 50	Alle	800280	10,-	13:-
Jog Space Innovation 50	Alle	800280	10,-	13:-
Jog-R AC 50	Alle	800280	10,-	13:-
Jog-RR LC 50	Alle	800280	10,-	13:-
Neo's 50	Alle	800280	10,-	13:-
Why 50	Alle	800280	10,-	13:-



MÆRKE/MODEL	ÅRG.	Varenr.		
MÆRKE/MODELL	ÅRG.	Art.NR.	DKK	SEK
ADLY				
Cat 50	Alle	800500	498,-	623,-
Jet 50	Alle	800501	498,-	623,-
Silver Fox 50	Alle	800500	498,-	623,-
Super Sonic 50	Alle	800501	498,-	623,-
Thunder Bike 50	Alle	800501	498,-	623,-

APRILIA				
Amico 50	Alle	800500	498,-	623,-
Area 51 LC 50	Alle	800501	498,-	623,-
Gulliver 50	Alle	800501	498,-	623,-
Rally AC 50	Alle	800501	498,-	623,-
Rally LC 50	Alle	800501	498,-	623,-
Scarabeo 50	Alle	800501	498,-	623,-
Sonic AC 50	Alle	800501	498,-	623,-
Sonic LC 50	Alle	800501	498,-	623,-
SR - 50 www AC	Alle	800501	498,-	623,-
SR-50 AC	Alle	800501	498,-	623,-
SR-50 AC	->93	800500	498,-	623,-
SR-Racing 50, Stealth, Netscaper LC	Alle	800501	498,-	623,-
SR-Replica LC (Minarelli) 50	Alle	800501	498,-	623,-

ATALA				
Carosello 50	Alle	800501	498,-	623,-
Hacker AT-12 50	Alle	800502	498,-	623,-
Hacker LC 50	Alle	800502	498,-	623,-
Skeggia 50	Alle	800502	498,-	623,-
SX 50	07->			

AVANTI				
9 N 50 (4 t.)	Alle	800517	498,-	623,-
Sport Classic 50 (4 t.)	Alle	800517	498,-	623,-
Eagle 50 (4 t.)	Alle	800517	498,-	623,-
Avanti Wolf 50 (4 t.)	Alle	800517	498,-	623,-

BAOTAIN				
BT49QT-7 50 (4 t.)	Alle	800517	498,-	623,-
BT49QT-9 50 (4 t.)	Alle	800517	498,-	623,-
BT49QT-11 50 (4 t.)	Alle	800517	498,-	623,-
BT49QT-12C 50 (4 t.)	Alle	800517	498,-	623,-
BT49QT-12 50 (4 t.)	Alle	800517	498,-	623,-

BENDA				
Scout 50 (4 t.)	Alle	800517	498,-	623,-

BENELLI				
491 GT 50	Alle	800501	498,-	623,-
491 Sport 50	Alle	800501	498,-	623,-
K2/LC 50	Alle	800501	498,-	623,-

BETA				
Ark AC 50	Alle	800501	498,-	623,-
Ark LC 50	Alle	800501	498,-	623,-

CPI				
Aragon 50 (Euro 2)	Alle	800505	498,-	623,-
Formula 50 (Euro 2)	Alle	800505	498,-	623,-
Hussar 50 -12 mm	Alle	800505	498,-	623,-
Oliver/City (Euro 2) 50 -12 mm	Alle	800505	498,-	623,-
Popcorn 50 -10 mm	->01	800503	498,-	623,-
Popcorn 50 -12 mm	Alle	800505	498,-	623,-

DAELIM				
S-Five 50	Alle	800506	498,-	623,-

DERBI				
Atlantis 50	Alle	800507	498,-	623,-
GP1 50	Alle	800507	498,-	623,-
Hunter 50	Alle	800507	498,-	623,-
Manhattan 50	Alle	800507	498,-	623,-
Paddock 50	Alle	800507	498,-	623,-
Predator 50	Alle	800507	498,-	623,-
Senda R 50	>-06	800508	498,-	623,-
Senda SM X-treme 50	07->	800508	498,-	623,-

FALCON				
Big Wheel 50	Alle	800501	498,-	623,-
Star-50	Alle	800501	498,-	623,-

FYM				
QT 50	Alle	800517	498,-	623,-

GENERIC				
Ideo 50 - 12 mm	Alle	800505	498,-	623,-
Race 50	Alle	800505	498,-	623,-
Xor 50 - 12 mm	Alle	800505	498,-	623,-

MÆRKE/MODEL	ÅRG.	Varenr.		
MÆRKE/MODELL	ÅRG.	Art.NR.	DKK	SEK
GIANTCO				
G-Buddy 50 (4 t.)	Alle	800517	498,-	623,-
Sprint 50 (4 t.)	Alle	800517	498,-	623,-
Stealth 50 (4 t.)	Alle	800517	498,-	623,-
Venus 50 (4 t.)	Alle	800517	498,-	623,-

GILERA				
DNA LC 50	Alle	800507	498,-	623,-
ICE AC 50	Alle	800507	498,-	623,-
RCR Off-road 50	Alle	800508	498,-	623,-
Runner AC 50	Alle	800507	498,-	623,-
Runner LC 50	Alle	800507	498,-	623,-
Runner-SP LC 50	Alle	800507	498,-	623,-
SMT Motard 50	Alle			
Stalker 50	Alle	800507	498,-	623,-
Storm 50	Alle	800507	498,-	623,-
Typhoon 50	Alle	800507	498,-	623,-
Typhoon-X 50	02->	800507	498,-	623,-

HONDA				
SFX 50	Alle	800509	498,-	623,-
Sky 50	Alle	800509	498,-	623,-

HOOPER				
One 50 (4 t.)	Alle	800517	498,-	623,-

HYOSUNG				
SB 50 M (Cab)	99>	800518	1298,-	1623,-
SF 50 B (Racing)	00>	800519	1298,-	1623,-
SF 50 R (Rally)	00>	800519	1298,-	1623,-

KEEWAY				
F-act 50	Alle	800505	498,-	623,-
Flash 50	Alle	800505	498,-	623,-
Focus 50 - 12 mm	Alle	800505	498,-	623,-
Matrix 50 - 12 mm	Alle	800505	498,-	623,-

KYMCO				
Agility 50 (4 t.)	Alle	800517	498,-	623,-
K-12 50	Alle			
NZ-50 Super Fever	03->			
People 50	Alle			
Super 8 50 (4 t.)	Alle	800517	498,-	623,-
Super 9 50	Alle			

MALAGUTI				
F10 AC 50	Alle	800501	498,-	623,-
F12 Phantom AC 50	Alle	800501	498,-	623,-
F15 Firefox LC 50	Alle	800501	498,-	498,-

PEUGEOT				
Buxy 50	94->	800510	498,-	623,-
Elyseo 50	Alle	800510	498,-	623,-
Elystar 50	Alle	800510	498,-	623,-
Fox 50	Alle	800510	498,-	623,-
Looxor 50	94->	800510	498,-	623,-
Ludix 50 One	94->	800510	498,-	623,-
Speedake 50	95->	800510	498,-	623,-
Speedfight -2 AC 50	Alle	800510	498,-	623,-
Speedfight AC 50	Alle	800510	498,-	623,-
Speedfight LC 50	Alle	800510	498,-	623,-
Squab 50	Alle	800510	498,-	623,-
TKR 50	94->	800510	498,-	623,-
Trekker 50	Alle	800510	498,-	623,-
Trekker/Metal X 50	Alle	800510	498,-	623,-
V-Clic 50 (4 t.)	Alle	800517	498,-	623,-
Vivacity 50	Alle	800510	498,-	623,-
Zenith 50	Alle	800510	498,-	623,-

PEXMA				
KDQT 50 (4 t.)	Alle	800517	498,-	623,-

PGO				
Black Magic 50	Alle	800511	498,-	623,-
Bubu 50	Alle	800511	498,-	623,-
Dr. Big 50	Alle	800511	498,-	623,-
Galaxy 50	Alle	800511	498,-	623,-
G-Max 50	Alle	800511	498,-	623,-
Hot-50 / Big Max 50	Alle	800511	498,-	623,-
Ligerio 50	Alle	800511	498,-	623,-
PMS 50	Alle	800511	498,-	623,-
PMX 50	Alle	800511	498,-	623,-
Rodoshow 50	Alle	800511	498,-	623,-
Streetfighter 50	Alle	800511	498,-	623,-
T-Rex 50	Alle	800511	498,-	623,-
Tornado 50	Alle	800511	498,-	623,-



Forhandlere
Återförsäljare
s. 2

Stikord
Sökord
s. 4

Tøj/hjelme
Kläder/
hjälmår
s. 6

Dæk og
slanger
Däck och
slangar
s. 15

Olie / spray
Olja / spray
s. 26

Kæder /
tandhjul
Kedjor /
drev
s. 43

Bremsedele
Bromsdelar
s. 48

Låse
Lås
s. 93

Batteri
Batteri
s. 96

Cylinder /
topstykke
Cylinder /
topplöck
s. 105

Motordele
Motordeklar
s. 137

Karburator
- Luftfilter
Förgasare
- Luftfilter
s. 208

El-dele
tændrør
Elektriskt
tändstift
s. 222

Udstødning
Avgassystem
s. 246

Forgaffel
Støddæmpere
Framgaffel
Støtdämpare
s. 260

Kabler
Wire
s. 266

Styr og
greb
Styre och
handtag
s. 272

Spejle
Speglar
s. 282

Blinklygter
Baglygter
Blinkers
Baklygte
s. 284

Støtteben
Topboks, mm.
Stödd
Topbbox, mm
s. 291

Rep. bøger
værktøj
Rep. böcker
Verktyg
s. 297

MÆRKE/MODEL	ÅRG.	Varenr.	DKK	SEK
MÄRKE/MODELL	ÅRG.	Art.NR.	DKK	SEK
PIAGGIO/VESPA				
ET2 50	Alle	800507	498,-	623:-
Fly 50	Alle	800507	498,-	623:-
Free 50	Alle	800507	498,-	623:-
Liberty 50	Alle	800507	498,-	623:-
NRG Extreme MC3 AC 50	Alle	800507	498,-	623:-
NRG Extreme MC3 LC 50	Alle	800507	498,-	623:-
NRG MC-2 LC 50	Alle	800507	498,-	623:-
Typhoon 50	Alle	800507	498,-	623:-
Typhoon-X 50	Alle	800507	498,-	623:-
Zip 2000 50	Alle	800507	498,-	623:-
Zip 50	Alle	800507	498,-	623:-

MÆRKE/MODEL	ÅRG.	Varenr.	DKK	SEK
SANELI				
Bahne 50 (4 t.)	Alle	800517	498,-	623:-

MÆRKE/MODEL	ÅRG.	Varenr.	DKK	SEK
STRANGER				
X-fight 50	Alle	800517	498,-	623:-

MÆRKE/MODEL	ÅRG.	Varenr.	DKK	SEK
SUZUKI				
Adress AP-50	Alle	800502	498,-	623:-
Katana AY 50 AC	97-98	800514	498,-	623:-
Katana AY 50 LC	97-98	800515	498,-	623:-
Katana AY 50 W/LC	99->	800516	498,-	623:-
RMX 50 Off-road	Alle	800512	498,-	623:-
SMX 50 Super Motard	Alle	800512	498,-	623:-

MÆRKE/MODEL	ÅRG.	Varenr.	DKK	SEK
SYM				
Jet 50	Alle	800513	498,-	623:-
Super Fancy 50	Alle	800513	498,-	623:-

MÆRKE/MODEL	ÅRG.	Varenr.	DKK	SEK
TOBILINER				
QT 50 (4 t.)	Alle	800517	498,-	623:-

MÆRKE/MODEL	ÅRG.	Varenr.	DKK	SEK
TEXAS				
Chili 50 (4 t.)	Alle	800517	498,-	623:-
City 50 (4 t.)	Alle	800517	498,-	623:-

MÆRKE/MODEL	ÅRG.	Varenr.	DKK	SEK
MÄRKE/MODELL	ÅRG.	Art.NR.	DKK	SEK
TEXAS				
Flash 50 (4 t.)	Alle	800517	498,-	623:-
Free 50 (4 t.)	Alle	800517	498,-	623:-

MÆRKE/MODEL	ÅRG.	Varenr.	DKK	SEK
TGB/TOBI				
303/309 50	Alle			
Akros 50	Alle			

MÆRKE/MODEL	ÅRG.	Varenr.	DKK	SEK
TMP				
Baboon 50	Alle	800501	498,-	623:-
Gazelle 50	Alle	800501	498,-	623:-

MÆRKE/MODEL	ÅRG.	Varenr.	DKK	SEK
TMS				
Retro 50 (4 t.)	Alle	800517	498,-	623:-
S3 50 (4 t.)	Alle	800517	498,-	623:-
Z2 50 (4 t.)	Alle	800517	498,-	623:-

MÆRKE/MODEL	ÅRG.	Varenr.	DKK	SEK
YAMAHA				
Aerox 50	Alle	800501	498,-	623:-
Axis 50	Alle	800501	498,-	623:-
Bump 50	Alle	800500	498,-	623:-
BW's 50	Alle	800500	498,-	623:-
BW's N.G. 50	Alle	800500	498,-	623:-
Jog Artistic - Fine Selection 50	Alle	800501	498,-	623:-
Jog Space Innovation 50	Alle	800501	498,-	623:-
Jog-R 50	Alle	800501	498,-	623:-
Jog-RR 50	Alle	800501	498,-	623:-
Neo's 50	Alle	800501	498,-	623:-
Slider 50	Alle	800500	498,-	623:-
Spy 50	Alle	800500	498,-	623:-
Why 50	Alle	800501	498,-	623:-

MÆRKE/MODEL	ÅRG.	Varenr.	DKK	SEK
YIYING				
Stranger 50 (4 t.)	Alle	800517	498,-	623:-

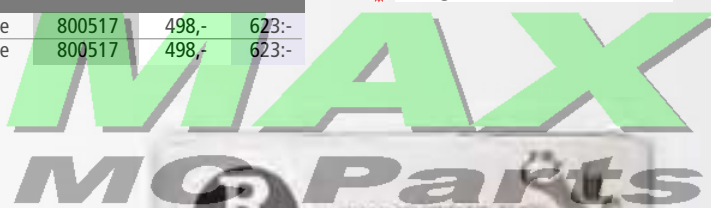

DK PLEJLSTANGSKIT
SE VEVSTAKSKIT

MÆRKE/MODEL	ÅRG.	Varenr.	DKK	SEK
MÄRKE/MODELL	ÅRG.	Art.NR.	DKK	SEK
ADLY				
Cat 50	Alle	300461	212,-	265:-
Jet 50	Alle	300461	212,-	265:-
Silver Fox 50	Alle	300461	212,-	265:-
Super Sonic 50	Alle	300461	212,-	265:-
Thunder Bike 50	Alle	300461	212,-	265:-

MÆRKE/MODEL	ÅRG.	Varenr.	DKK	SEK
APRILIA				
Amico 50	Alle	300461	212,-	265:-
Area 51 LC 50	98->	300461	212,-	265:-
Classic 50	Alle	300501	212,-	265:-
Gulliver 50	Alle	300461	212,-	265:-
Habana AC (Morini) 50	Alle	300461	212,-	265:-
Rally AC 50	Alle	300461	212,-	265:-
RS 50 (AM-6)	Alle	300504	289,-	361:-
Scarabeo 50	Alle	300461	212,-	265:-
Sonic AC 50	Alle	300461	212,-	265:-
Sonic LC 50	Alle	300461	212,-	265:-
SR - www AC 50	97->	300461	212,-	265:-
SR-50 AC	Alle	300461	212,-	265:-
SR-Racing 50, Stealth, Netscaper LC	Alle	300461	212,-	265:-
SR-Replica LC (Minarelli) 50	->00	300461	212,-	265:-

MÆRKE/MODEL	ÅRG.	Varenr.	DKK	SEK
ATALA				
Carosello 50	Alle	300461	212,-	265:-

MÆRKE/MODEL	ÅRG.	Varenr.	DKK	SEK
BENELLI				
491 GT 50	97->	300461	212,-	265:-
491 Sport 50	97->	300461	212,-	265:-
K2/LC 50	Alle	300461	212,-	265:-

MÆRKE/MODEL	ÅRG.	Varenr.	DKK	SEK
BETA				
Ark AC 50	Alle	300461	212,-	265:-
Ark LC 50	Alle	300461	212,-	265:-

MÆRKE/MODEL	ÅRG.	Varenr.	DKK	SEK
MÄRKE/MODELL	ÅRG.	Art.NR.	DKK	SEK
CPI				
ATV 50 cc - 10 mm.	Alle	300461	212,-	265:-
Popcorn 50 - 10 mm.	Alle	300461	212,-	265:-

MÆRKE/MODEL	ÅRG.	Varenr.	DKK	SEK
FALCON				
Big Wheel 50	Alle	300461	212,-	265:-
Star-50	Alle	300461	212,-	265:-

MÆRKE/MODEL	ÅRG.	Varenr.	DKK	SEK
HONDA				
Vision Met In 50	Alle	300110	212,-	265:-
Vision SA 50	Alle	300110	212,-	265:-

MÆRKE/MODEL	ÅRG.	Varenr.	DKK	SEK
KREIDLER				
Easy Rider 50	Alle	300461	212,-	265:-

MÆRKE/MODEL	ÅRG.	Varenr.	DKK	SEK
MALAGUTI				
F10 AC 50	Alle	300461	212,-	265:-
F12 Phantom AC 50	Alle	300461	212,-	265:-
F15 Firefox LC 50	Alle	300461	212,-	265:-

MÆRKE/MODEL	ÅRG.	Varenr.	DKK	SEK
PGO				
Big Max 50	Alle	300461	212,-	265:-
Black Magic 50	Alle	300461	212,-	265:-
Bubu 50	Alle	300461	212,-	265:-
Comet 50	Alle	300502	289,-	361:-
Dr. Big 50	Alle	300461	212,-	265:-
Galaxy 50	Alle	300461	212,-	265:-
G-Max 50	Alle	300461	212,-	265:-
Hot-50	Alle	300461	212,-	265:-
Ligero 50	Alle	300461	212,-	265:-
PMS 50	Alle	300461	212,-	265:-
PMX 50	Alle	300461	212,-	265:-
Rodoshow 50	Alle	300461	212,-	265:-
Streetfighter 50	Alle	300461	212,-	265:-
T-Rex 50	Alle	300461	212,-	265:-



MÆRKE/MODEL	ÅRG.	Varenr.		
MÆRKE/MODELL	ÅRG.	Art.NR.	DKK	SEK
PGO				
Tornado 50	Alle	300461	212,-	265,-
RIEJU				
Alle modeller (m. AM-6 motor)	Alle	300504	289,-	361,-
SUZUKI				
FZ-50	Alle	300260	212,-	265,-
RMX 50	Alle	300500	289,-	361,-
SMX 50	Alle	300500	416,-	361,-
Street Magic, TR-50S	Alle	300503	289,-	361,-
TMP				
Baboon 50	Alle	300461	212,-	265,-
Gazelle 50	Alle	300461	212,-	265,-

MÆRKE/MODEL	ÅRG.	Varenr.		
MÆRKE/MODELL	ÅRG.	Art.NR.	DKK	SEK
YAMAHA				
Aerox 50	Alle	300461	212,-	265,-
Axis 50	95->	300461	212,-	265,-
Bump 50	97->	300461	212,-	265,-
BW's 50	Alle	300461	212,-	265,-
BW's N.G. 50	96->	300461	212,-	265,-
DT-50LC	Alle	300501	212,-	265,-
Jog Artistic -Fine Selection 50	Alle	300461	212,-	265,-
Jog Space Innovation 50	98->	300461	212,-	265,-
Jog-R 50	03->	300461	212,-	265,-
Jog-RR 50	03->	300461	212,-	265,-
Neo's 50	Alle	300461	212,-	265,-
Passala 50	Alle	300386	235,-	294,-
RD 50	Alle	300501	289,-	361,-
Slider 50	01->	300461	212,-	265,-
Spy 50	Alle	300461	212,-	265,-
TZR 50 (AM-6)	Alle	300504	289,-	361,-
Why 50	99->	300461	212,-	265,-



MAX

MÆRKE/MODEL	ÅRG.	VARENDR.		
MÆRKE/MODELL	ÅRG.	ART.NR.	DKK	SEK
ADLY				
Cat 50	Alle	110060	91,-	114,-
Jet 50	Alle	110060	91,-	114,-
Silver Fox 50	Alle	110060	91,-	114,-
Super Sonic 50	Alle	110060	91,-	114,-
Thunder Bike 50	Alle	110060	91,-	114,-
APRILIA				
Amico 50	Alle	110060	91,-	114,-
Area 51 LC 50	98->	110060	91,-	114,-
Gulliver 50	Alle	110060	91,-	114,-
Rally AC 50	Alle	110060	91,-	114,-
Scarabeo 50	Alle	110060	91,-	114,-
Sonic AC 50	98->	110060	91,-	114,-
Sonic LC 50	Alle	110060	91,-	114,-
SR - www AC 50	97->	110060	91,-	114,-
SR-50 AC	->96	110060	91,-	114,-
SR-Racing, Stealth, Netscaper LC	Alle	110060	91,-	114,-
SR-Replica LC (Minarelli) 50	->00	110060	91,-	114,-
AVANTI				
9 N 50 (4 t.)	Alle	110064	89,-	111,-
Sport Classic 50 (4 t.)	Alle	110064	89,-	111,-
Eagle 50 (4 t.)	Alle	110064	89,-	111,-
Avanti Wolf 50 (4 t.)	Alle	110064	89,-	111,-
BAOTAIN				
BT49QT-7 50 (4 t.)	Alle	110064	89,-	111,-
BT49QT-9 50 (4 t.)	Alle	110064	89,-	111,-
BT49QT-11 50 (4 t.)	Alle	110064	89,-	111,-
BT49QT-12C 50 (4 t.)	Alle	110064	89,-	111,-
BT49QT-12 50 (4 t.)	Alle	110064	89,-	111,-
BENDA				
Scoot 50 (4 t.)	Alle	110064	89,-	111,-

MÆRKE/MODEL	ÅRG.	VARENDR.		
MÆRKE/MODELL	ÅRG.	ART.NR.	DKK	SEK
BENELLI				
491 GT 50	97->	110060	91,-	114,-
491 Sport 50	97->	110060	91,-	114,-
K2/LC 50	->96	110060	91,-	114,-
BETA				
Ark AC 50	Alle	110060	91,-	114,-
Ark LC 50	Alle	110060	91,-	114,-
CPI				
Aragon 50 (Euro 2)	Alle	110060	91,-	114,-
ATV 50 cc	Alle	110060	91,-	114,-
Formula R 50 (Euro 2)	Alle	110060	91,-	114,-
Hussar 50	Alle	110060	91,-	114,-
Oliver/City 50 (Euro 2)	03->	110060	91,-	114,-
Popcorn 50	Alle	110060	91,-	114,-
FYM				
QT 50	Alle	110064	89,-	111,-
GENERIC				
Ideo 50	Alle	110060	91,-	114,-
Race 50	Alle	110060	91,-	114,-
Xor 50	Alle	110060	91,-	114,-
GIANTCO				
G-Buddy 50 (4 t.)	Alle	110064	89,-	111,-
Sprint 50 (4 t.)	Alle	110064	89,-	111,-
Stealth 50 (4 t.)	Alle	110064	89,-	111,-
Venus 50 (4 t.)	Alle	110064	89,-	111,-
GILERA				
ICE AC 50	Alle	110062	91,-	114,-
Runner AC 50	Alle	110062	91,-	114,-
Stalker 50	Alle	110062	91,-	114,-
Storm 50	Alle	110062	91,-	114,-



MÆRKE/MODEL	ÅRG.	VARENR.	DKK	SEK
MÄRKE/MODELL	ÅRG.	ART.NR.	DKK	SEK
GILERA				
Typhoon 50	Alle	110062	91,-	114:-
Typhoon-X 50	02->	110062	91,-	114:-
HOOPER				
One 50 (4 t.)	Alle	110064	89,-	111:-
HYOSUNG				
SB 50 M (Cab)	99>	110120	59,-	74:-
SF 50 B (Racing)	00>	110120	59,-	74:-
SF 50 R (Rally)	00>	110120	59,-	74:-
KEEWAY				
F-act 50	Alle	110060	91,-	114:-
Flash 50	Alle	110060	91,-	114:-
Focus 50	Alle	110060	91,-	114:-
Matrix 50	Alle	110060	91,-	114:-
KREIDLER				
Easy Rider 50	Alle	110060	91,-	114:-
KYMCO				
Agility 50 (4 t.)	Alle	110064	89,-	114:-
Super 8 50 (4 t.)	Alle	110064	89,-	114:-
MALAGUTI				
F10 AC 50	Alle	110060	91,-	114:-
F12 Phantom AC 50	Alle	110060	91,-	114:-
F15 Firefox LC 50	Alle	110060	91,-	114:-
PEUGEOT				
V-Clic 50 (4 t.)	Alle	110064	89,-	111:-
PEXMA				
KDQT 50 (4 t.)	Alle	110064	89,-	111:-
PGO				
Big Max 50	Alle	110063	91,-	114:-
Black Magic 50	Alle	110063	91,-	114:-
Bubu 50	Alle	110063	91,-	114:-
Comet 50	Alle	110063	91,-	114:-
Dr. Big 50	Alle	110063	91,-	114:-
Galaxy 50	Alle	110063	91,-	114:-
G-Max 50	Alle	110063	91,-	114:-
Hot-50	Alle	110063	91,-	114:-
Ligero 50	Alle	110063	91,-	114:-
PMS 50	Alle	110063	91,-	114:-
PMX 50	Alle	110063	91,-	114:-
Rodoshow 50	Alle	110063	91,-	114:-
Streetfighter 50	Alle	110063	91,-	114:-
T-Rex 50	Alle	110063	91,-	114:-
Tornado 50	Alle	110063	91,-	114:-
PIAGGIO/VESPA				
ET2 50	97->	110062	91,-	114:-
Fly 50	Alle	110062	91,-	114:-
Free 50	Alle	110062	91,-	114:-
Liberty 50	Alle	110062	91,-	114:-
NRG Extreme MC3 AC 50	Alle	110062	91,-	114:-
NRG MC-2 LC 50	94->	110062	91,-	114:-
Typhoon 50	01	110062	91,-	114:-
Typhoon-X 50	01	110062	91,-	114:-
Zip 50	93->	110062	91,-	114:-

MÆRKE/MODEL	ÅRG.	VARENR.	DKK	SEK
MÄRKE/MODELL	ÅRG.	ART.NR.	DKK	SEK
SANELI				
Bahne 50 (4 t.)	Alle	110064	89,-	111:-
STRANGER				
X-fight 50 (4 t.)	Alle	110064	89,-	111:-
TEXAS				
Chili 50 (4 t.)	Alle	110064	89,-	111:-
City 50 (4 t.)	Alle	110064	89,-	111:-
Flash 50 (4 t.)	Alle	110064	89,-	111:-
Free 50 (4 t.)	Alle	110064	89,-	111:-
TMP				
Baboon 50	Alle	110060	91,-	114:-
Gazelle 50	Alle	110060	91,-	114:-
TMS				
Retro 50 (4 t.)	Alle	110064	89,-	111:-
S3 50 (4 t.)	Alle	110064	89,-	111:-
Z2 50 (4 t.)	Alle	110064	89,-	111:-
TOBILINER				
QT 50 (4 t.)	Alle	110064	89,-	111:-
YAMAHA				
Aerox 50	97->	110060	91,-	114:-
Axis 50	95->	110060	91,-	114:-
Bump 50	97->	110060	91,-	114:-
BW's 50	96->	110060	91,-	114:-
BW's N.G. 50	->96	110060	91,-	114:-
Jog Artistic -Fine Selection 50	Alle	110060	91,-	114:-
Jog Space Innovation 50	98->	110060	91,-	114:-
Jog-R 50	03->	110060	91,-	114:-
Jog-RR 50	03->	110060	91,-	114:-
Neo's 50	97->	110060	91,-	114:-
Slider 50	01->	110060	91,-	114:-
Spy 50	Alle	110060	91,-	114:-
Why 50	99->	110060	91,-	114:-
YIYING				
Stranger 50 (4 t.)	Alle	110064	89,-	111:-



Mærke/model	Årg.	Standard Varenr.	DKK		SEK		Racing Varenr.	DKK		SEK	
Mærke/modell	Årg.	Standard Art.nr.	DKK	SEK	Racing Art.nr.	DKK	SEK	DKK	SEK	DKK	SEK
ADLY											
Cat 50	Alle	300851	598,-	748,-	300901	798,-	998,-				
Jet 50	Alle	300851	598,-	748,-	300901	798,-	998,-				
Silver Fox 50	Alle	300850	598,-	748,-	300900	798,-	998,-				
Super Sonic 50	Alle	300851	598,-	748,-	300901	798,-	998,-				
Thunder Bike 50	Alle	300851	598,-	748,-	300901	798,-	998,-				

APRILIA											
Mærke/model	Årg.	Standard Varenr.	DKK		SEK		Racing Varenr.	DKK		SEK	
Mærke/modell	Årg.	Standard Art.nr.	DKK	SEK	Racing Art.nr.	DKK	SEK	DKK	SEK	DKK	SEK
Amico 50	Alle	300850	598,-	748,-	300900	798,-	998,-				
Area 51 LC	98>	300851	598,-	748,-	300901	798,-	998,-				
Classic 50	Alle	300871	598,-	748,-	300909	798,-	998,-				
Gulliver AC 50	Alle	300851	598,-	748,-	300901	798,-	998,-				
Habana 50	Alle	300863	598,-	748,-							
MX-50	Alle	300871	598,-	598,-	300909	798,-	998,-				
Rally AC 50	>96	300851	598,-	748,-	300901	798,-	998,-				
RS-50	Alle	300871	598,-	748,-	300909	798,-	998,-				
RX-50	Alle	300871	598,-	748,-	300909	798,-	998,-				
Scarabeo AC 50	Alle	300851	598,-	748,-	300901	798,-	998,-				
Scarabeo Diteck 50	Alle	300882	598,-	748,-							
Sonic AC 50	98>	300851	598,-	748,-	300901	798,-	998,-				
Sonic LC 50	Alle	300851	598,-	748,-	300901	798,-	998,-				
SR 50 AC	>93	300850	598,-	748,-	300900	798,-	998,-				
SR 50 AC	Alle	300851	598,-	748,-	300901	798,-	998,-				
SR - www AC 50	97>	300851	598,-	748,-	300901	798,-	998,-				
SR Diteck LC (Morini) 50	Alle	300882	598,-	748,-							
SR-Racing,											
Stealth, Netscaper LC 50	Alle	300851	598,-	748,-	300901	798,-	998,-				
SR-Replica LC 50	>00	300851	598,-	748,-	300901	798,-	998,-				
SX 50	07>	300885	598,-	748,-	300911	798,-	998,-				

ATALA											
Mærke/model	Årg.	Standard Varenr.	DKK		SEK		Racing Varenr.	DKK		SEK	
Mærke/modell	Årg.	Standard Art.nr.	DKK	SEK	Racing Art.nr.	DKK	SEK	DKK	SEK	DKK	SEK
Carosello 50	Alle	300851	598,-	748,-	300901	798,-	998,-				
Hacker AT-12 50	Alle	300858	598,-	748,-	300905	798,-	998,-				
Hacker LC 50	Alle	300858	598,-	748,-	300905	798,-	998,-				
Skeggia 50	Alle	300858	598,-	748,-	300905	798,-	998,-				

BENELLI											
Mærke/model	Årg.	Standard Varenr.	DKK		SEK		Racing Varenr.	DKK		SEK	
Mærke/modell	Årg.	Standard Art.nr.	DKK	SEK	Racing Art.nr.	DKK	SEK	DKK	SEK	DKK	SEK
491 GT 50	97>	300851	598,-	748,-	300901	798,-	998,-				
491 Sport 50	97>	300851	598,-	748,-	300901	798,-	998,-				
K2/LC/AC 50	Alle	300851	598,-	748,-	300901	798,-	998,-				
Pepe 50		300851	598,-	748,-	300901	798,-	998,-				

BETA											
Mærke/model	Årg.	Standard Varenr.	DKK		SEK		Racing Varenr.	DKK		SEK	
Mærke/modell	Årg.	Standard Art.nr.	DKK	SEK	Racing Art.nr.	DKK	SEK	DKK	SEK	DKK	SEK
Ark AC 50	Alle	300851	598,-	748,-	300901	798,-	998,-				
Ark/LC 50	Alle	300851	598,-	748,-	300901	798,-	998,-				
Quadro 50	Alle	300851	598,-	748,-	300901	798,-	998,-				

CPI											
Mærke/model	Årg.	Standard Varenr.	DKK		SEK		Racing Varenr.	DKK		SEK	
Mærke/modell	Årg.	Standard Art.nr.	DKK	SEK	Racing Art.nr.	DKK	SEK	DKK	SEK	DKK	SEK
Aragon 50 (Euro 2)	Alle	300881	598,-	748,-							
Formula R 50 (Euro 2)	Alle	300881	598,-	748,-							
Hussar 50 - 12 mm.	Alle	300881	598,-	748,-							
Oliver/City 50 - (Euro 2)	Alle	300881	598,-	748,-							
Popcorn 50 - 10 mm.	Alle	300880	598,-	748,-							
Popcorn 50 - 12 mm.	Alle	300881	598,-	748,-							

DERBI											
Mærke/model	Årg.	Standard Varenr.	DKK		SEK		Racing Varenr.	DKK		SEK	
Mærke/modell	Årg.	Standard Art.nr.	DKK	SEK	Racing Art.nr.	DKK	SEK	DKK	SEK	DKK	SEK
Atlantis (Piaggio) 50	03>	300852	598,-	748,-	300903	798,-	998,-				
GP1(Piaggio) 50	03>	300852	598,-	748,-	300903	798,-	998,-				
GPR 50	Alle	300861	598,-	748,-	300907	798,-	998,-				
Hunter 50	Alle	300859	598,-	748,-							
Manhattan 50	Alle	300859	598,-	748,-							
Paddock 50	Alle	300859	598,-	748,-							
Predator LC 50	Alle	300859	598,-	748,-							
Senda R 50	>06	300860	598,-	748,-	300906	798,-	998,-				
Senda 50	07>	300885	598,-	748,-	300911	798,-	998,-				
Senda SM X-treme 50	07>										

FALCON											
Mærke/model	Årg.	Standard Varenr.	DKK		SEK		Racing Varenr.	DKK		SEK	
Mærke/modell	Årg.	Standard Art.nr.	DKK	SEK	Racing Art.nr.	DKK	SEK	DKK	SEK	DKK	SEK
Big Wheel 50	Alle	300851	598,-	748,-	300901	798,-	998,-				
Star-50	Alle	300851	598,-	748,-	300901	798,-	998,-				

GENERIC											
Mærke/model	Årg.	Standard Varenr.	DKK		SEK		Racing Varenr.	DKK		SEK	
Mærke/modell	Årg.	Standard Art.nr.	DKK	SEK	Racing Art.nr.	DKK	SEK	DKK	SEK	DKK	SEK
Ideo 50 - 12 mm.	Alle	300881	598,-	748,-							
Race 50 12 mm.	Alle	300881	598,-	748,-							
Xor 50 - 12 mm.	Alle	300881	598,-	748,-							

GILERA											
Mærke/model	Årg.	Standard Varenr.	DKK		SEK		Racing Varenr.	DKK		SEK	
Mærke/modell	Årg.	Standard Art.nr.	DKK	SEK	Racing Art.nr.	DKK	SEK	DKK	SEK	DKK	SEK
DNA LC 50	Alle	300852	598,-	748,-	300903	798,-	998,-				
ICE AC 50	Alle	300852	598,-	748,-	300903	798,-	998,-				
Runner, LC 50	Alle	300852	598,-	748,-	300903	798,-	998,-				
Runner PJ 50	03>	300852	598,-	748,-	300903	798,-	998,-				
Runner SP LC 50	02>	300852	598,-	748,-	300903	798,-	998,-				
SMT 50	>06	300860	598,-	748,-	300906	798,-	998,-				

Mærke/model	Årg.	Standard Varenr.	DKK		SEK		Racing Varenr.	DKK		SEK	
Mærke/modell	Årg.	Standard Art.nr.	DKK	SEK	Racing Art.nr.	DKK	SEK	DKK	SEK	DKK	SEK
GILERA											
SMT 50	07>	300885	598,-	748,-	300911	798,-	998,-				
Stalker 50	Alle	300852	598,-	748,-	300903	798,-	998,-				
Storm 50	Alle	300852	598,-	748,-	300903	798,-	998,-				
Typhoon 50	>01	300852	598,-	748,-	300903	798,-	998,-				
Typhoon-X 50	02>	300852	598,-	748,-	300903	798,-	998,-				

HONDA											
Mærke/model	Årg.	Standard Varenr.	DKK		SEK		Racing Varenr.	DKK		SEK	
Mærke/modell	Årg.	Standard Art.nr.	DKK	SEK	Racing Art.nr.	DKK	SEK	DKK	SEK	DKK	SEK
SFX 50	Alle	300854	598,-	748,-							
Vision Met In 50	Alle	300853	598,-	748,-	300904	798,-	998,-				
Vision SA 50	Alle	300853	598,-	748,-	300904	798,-	998,-				
Wallaroo 50	Alle	300862	598,-	748,-							
X8-R 50	Alle	300855	598,-	748,-							

HYOSUNG											
Mærke/model	Årg.	Standard Varenr.	DKK		SEK		Racing Varenr.	DKK		SEK	
Mærke/modell	Årg.	Standard Art.nr.	DKK	SEK	Racing Art.nr.	DKK	SEK	DKK	SEK	DKK	SEK
SB 50 M (Cab)	Alle	300858	598,-	748,-	300905	798,-	998,-				
SF 50 B (Racing)	Alle	300858	598,-	748,-	300905	798,-	998,-				
SF 50 R (Rally)	Alle	300858	598,-	748,-	300905	798,-	998,-				

ITALJET											
Mærke/model	Årg.	Standard Varenr.	DKK		SEK		Racing Varenr.	DKK		SEK	
Mærke/modell	Årg.	Standard Art.nr.	DKK	SEK	Racing Art.nr.	DKK	SEK	DKK	SEK	DKK	SEK
Dragster/LC 50	Alle	300851	598,-	748,-	300901	798,-	998,-				
Formula 50	Alle	300858	598,-	748,-	300905	798,-	998,-				
Torpedo 50	Alle	300858	598,-	748,-	300905	798,-	998,-				
Velocifero 50	Alle	3008									

Mærke/model	Årg.	Standard Varenr.	DKK		SEK		Racing Varenr.
Mærke/modell	Årg.	Standard Art.nr.	DKK	SEK	Racing Art.nr.	DKK	SEK

PIAGGIO/VESPA							
ET2 50	97->	300852	598,-	748,-	300903	798,-	998,-
Fly 50	Alle	300852	598,-	748,-	300903	798,-	998,-
Free 50	Alle	300852	598,-	748,-	300903	798,-	998,-
Liberty 50	Alle	300852	598,-	748,-	300903	798,-	998,-
NRG Extreme MC3 AC 50	03->	300852	598,-	748,-	300903	798,-	998,-
NRG Extreme MC3 LC 50	01->	300852	598,-	748,-	300903	798,-	998,-
NRG MC-2 LC 50	94->	300852	598,-	748,-	300903	798,-	998,-
Quartz 50	Alle	300852	598,-	748,-	300903	798,-	998,-
Typhoon 50	Alle	300852	598,-	748,-	300903	798,-	998,-
Typhoon-X 50	02->	300852	598,-	748,-	300903	798,-	998,-
Zip 50	00->	300852	598,-	748,-	300903	798,-	998,-
Zip 50	93->	300852	598,-	748,-	300903	798,-	998,-

PUCH							
Maxi P-K 50	Alle	300873	598,-	748,-	300910	798,-	998,-

RIEJU							
Alle modeller (m. AM-6 motor)	Alle	300871	598,-	748,-	300909	798,-	998,-

SUZUKI							
Adress AP 50	Alle	300858	598,-	748,-	300905	798,-	998,-
Katana AY50 AC	97-98	300863	598,-	748,-			
Katana AY50 LC	97-98	300864	598,-	748,-			
Katana AY50 W/LC	99->	300866	598,-	748,-			
Street Magic 50	Alle	300865	598,-	748,-			
Zillion LC 50	Alle	300866	598,-	748,-			

SYM							
Jet 50	Alle	300867	598,-	748,-			

TGB/TOBI							
303/309 50	Alle	300858	598,-	748,-	300905	798,-	998,-
Akros 50	Alle	300858	598,-	748,-	300905	798,-	998,-

TMP							
Baboon 50	Alle	300851	598,-	748,-	300901	798,-	998,-
Gazelle 50	Alle	300851	598,-	748,-	300901	798,-	998,-

YAMAHA							
Aerox 50	97->	300851	598,-	748,-	300901	798,-	998,-
Aerox R 50	03->	300851	598,-	748,-	300901	798,-	998,-
ATV 50 cc	Alle	300851	598,-	748,-	300901	798,-	998,-
Axis 50	95->	300851	598,-	748,-	300901	798,-	998,-
Bump 50	97->	300850	598,-	748,-	300900	798,-	998,-
BW's 50	->96	300850	598,-	748,-	300900	798,-	998,-
BW's N.G. 50	96->	300850	598,-	748,-	300900	798,-	998,-
DT-50LC	Alle	300868	598,-	748,-			
DT-50R	Alle	300869	598,-	748,-			
FS1 K/DX 50	Alle	300870	598,-	748,-			
Jog Artistic - Fine Selection	Alle	300851	598,-	748,-	300901	798,-	998,-
Jog Space Innovation 50	98->	300851	598,-	748,-	300901	798,-	998,-
Jog-R 50	03->	300851	598,-	748,-	300901	798,-	998,-
Jog-RR LC 50	03->	300851	598,-	748,-	300901	798,-	998,-
Neo's 50	97->	300851	598,-	748,-	300901	798,-	998,-
Slider 50	01->	300850	598,-	748,-	300900	798,-	998,-
Spy 50	Alle	300850	598,-	748,-	300900	798,-	998,-
TZR 50 R	Alle	300871	598,-	748,-	300909	798,-	998,-
Why 50	99->	300851	598,-	748,-	300901	798,-	998,-

STANDARD



Standard. Standard krumtap er fremstillet af et høj kvalitetsmateriale – bedre end originalt.

Standard. Standard vevparti är tillverkat högsta kvalitet – bättre än original.

RACING



Racing. 14000 RPM. Krumtap med helrund slag, forøger insugningseffekten. Monteret med sølv nåleleje i plejlstangen. Bedre end originalt.

Racing. 14000 RPM. Runt vevparti ökar insugningseffekten. Silver nållager i vevstaken. Bättre än original.

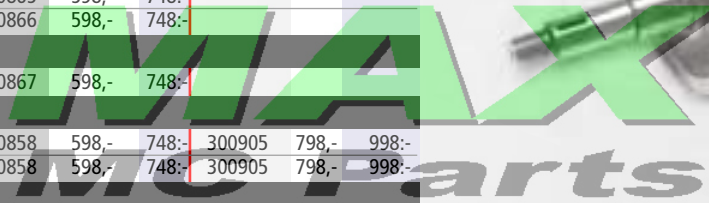

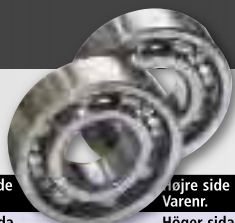

Mærke/model	Årg.	Venstre side Varenr.	DKK	SEK	Højre side Varenr.	DKK	SEK
Märke/modell	Årg.	Vänster sida Art.nr.	DKK	SEK	Höger sida Art.nr.	DKK	SEK
ADLY							
Cat 50	Alle	6204/C3	77,-	77,-	6204/C3	77,-	96,-
Jet 50	Alle	6204/C3	77,-	77,-	6204/C3	77,-	96,-
Silver Fox 50	Alle	6204/C3	77,-	77,-	6204/C3	77,-	96,-
Super Sonic 50	Alle	6204/C3	77,-	77,-	6204/C3	77,-	96,-
Thunder Bike 50	Alle	6204/C3	77,-	77,-	6204/C3	77,-	96,-

Mærke/model	Årg.	Venstre side Varenr.	DKK	SEK	Højre side Varenr.	DKK	SEK
Märke/modell	Årg.	Vänster sida Art.nr.	DKK	SEK	Höger sida Art.nr.	DKK	SEK
APRILIA							
Amico 50	Alle	6204/C3	77,-	77,-	6204/C3	77,-	96,-
Area 51 LC 50	98->	6204/C3	77,-	77,-	6204/C3	77,-	96,-
Classic (AM-6) 50	Alle	6303/C3	68,-	68,-	6303/C3	68,-	85,-
Gulliver 50	Alle	6204/C3	77,-	77,-	6204/C3	77,-	96,-
Habana AC (Morini) 50	Alle	255213	259,-	259,-	6204/C3	77,-	96,-
MX-50 (AM-6)	Alle	6303/C3	68,-	68,-	6303/C3	68,-	85,-
Rally AC 50	Alle	6204/C3	77,-	77,-	6204/C3	77,-	96,-
RS-50 (AM-6)	Alle	6303/C3	68,-	68,-	6303/C3	68,-	85,-
RX-50 (AM-6)	Alle	6303/C3	68,-	68,-	6303/C3	68,-	85,-
Scarabeo 50	Alle	6204/C3	77,-	77,-	6204/C3	77,-	96,-
Sonic AC 50	98->	6204/C3	77,-	77,-	6204/C3	77,-	96,-
Sonic LC 50	Alle	6204/C3	77,-	77,-	6204/C3	77,-	96,-
SR - Ditech (Morini) 50	Alle	255213	259,-	259,-	6204/C3	77,-	96,-
SR - www AC 50	97->	6204/C3	77,-	77,-	6204/C3	77,-	96,-
SR-50 AC	->96	6204/C3	77,-	77,-	6204/C3	77,-	96,-
SR-Racing, Stealth, Netscaper LC	Alle	6204/C3	77,-	77,-	6204/C3	77,-	96,-
SR-Replica LC (Minarelli) 50	->00	6204/C3	77,-	77,-	6204/C3	77,-	96,-
SR-Replica-2000 LC (Morini) 50	00->	255213	259,-	259,-	6204/C3	77,-	96,-
SX 50	07->	6204/C3	77,-	77,-	6204/C3	77,-	96,-

Mærke/model	Årg.	Venstre side Varenr.	DKK	SEK	Højre side Varenr.	DKK	SEK
Märke/modell	Årg.	Vänster sida Art.nr.	DKK	SEK	Höger sida Art.nr.	DKK	SEK
ATALA							
Carosello 50	Alle	255213	259,-	259,-	6204/C3	77,-	96,-
Hacker AT-12 50	Alle	255213	259,-	259,-	6204/C3	77,-	96,-
Hacker LC 50	Alle	255213	259,-	259,-	6204/C3	77,-	96,-
Skeggia 50	Alle	255213	259,-	259,-	6204/C3	77,-	96,-

Mærke/model	Årg.	Venstre side Varenr.	DKK	SEK	Højre side Varenr.	DKK	SEK
Märke/modell	Årg.	Vänster sida Art.nr.	DKK	SEK	Höger sida Art.nr.	DKK	SEK
BAOTAIN							
BT-QT-8/11 50 (4 t.)	Alle	6204/C3	77,-	96,-			
Rebel 50 (4 t.)	Alle	6204/C3	77,-	96,-			
Supermoto 50 (4 t.)	Alle	6204/C3	77,-	96,-			
Rocky 50 (4 t.)	Alle	6204/C3	77,-	96,-			

Mærke/model	Årg.	Venstre side Varenr.	DKK	SEK	Højre side Varenr.	DKK	SEK
Märke/modell	Årg.	Vänster sida Art.nr.	DKK	SEK	Höger sida Art.nr.	DKK	SEK
BENELLI							
491 GT 50	97->	6204/C3	77,-	77,-	6204/C3	77,-	96,-
491 Sport 50	97->	6204/C3	77,-	77,-	6204/C3	77,-	96,-
K2/LC 50	96->	6204/C3	77,-	77,-	6204/C3	77,-	96,-

Mærke/model	Årg.	Venstre side Varenr.	DKK	SEK	Højre side Varenr.	DKK	SEK
Märke/modell	Årg.	Vänster sida Art.nr.	DKK	SEK	Höger sida Art.nr.	DKK	SEK
BETA							
Ark AC 50	Alle	6204/C3	77,-	77,-	6204/C3	77,-	96,-
Ark LC 50	Alle	6204/C3	77,-	77,-	6204/C3	77,-	96,-
RK 6 50	Alle	6303/C3	68,-	68,-	6303/C3	68,-	68,-
RR 50	Alle	6303/C3	68,-	68,-	6303/C3	68,-	68,-

Mærke/model	Årg.	Venstre side Varenr.	DKK	SEK	Højre side Varenr.	DKK	SEK
Märke/modell	Årg.	Vänster sida Art.nr.	DKK	SEK	Höger sida Art.nr.	DKK	SEK
CPI							
Aragon 50 (Euro 2)	Alle	6204/C3	77,-	77,-	6204/C3	77,-	96,-
ATV 50 cc	Alle	6204/C3	77,-	77,-	6204/C3	77,-	96,-
Formula R 50 (Euro 2)	Alle	6204/C3	77,-	77,-	6204/C3	77,-	96,-
Hussar 50	Alle	6204/C3	77,-	77,-	6204/C3	77,-	96,-
Oliver/City 50 (Euro 2)	Alle	6204/C3	77,-	77,-	6204/C3	77,-	96,-
Popcorn 50	Alle	6204/C3	77,-	77,-	6204/C3	77,-	96,-
SM 50	Alle	6303/C3	68,-	68,-	6303/C3	68,-	68,-
SX 50	Alle	6303/C3	68,-	68,-	6303/C3	68,-	68,-

Mærke/model	Årg.	Venstre side Varenr.	DKK	SEK	Højre side Varenr.	DKK	SEK
Märke/modell	Årg.	Vänster sida Art.nr.	DKK	SEK	Höger sida Art.nr.	DKK	SEK
DERBI							
Atlantis 50	Alle	6204/C3	77,-	77,-	6204/C3	77,-	96,-
Atlantis (Piaggio) 50	03->	205212	205,-	205,-	205212	205,-	256,-
GP1 (Piaggio) 50	03->	205212	205,-	205,-	205212	205,-	256,-
GPR 50	Alle	6204/C3	77,-	77,-	6204/C3	77,-	96,-
Hunter 50	Alle	6204/C3	77,-	77,-	6204/C3	77,-	96,-
Manhattan 50	Alle	6204/C3	77,-	77,-	6204/C3	77,-	96,-
MotoGP (GP1) 50	Alle	6204/C3	77,-	77,-	6204/C3	77,-	96,-
Paddock AC 50	Alle	6204/C3	77,-	77,-	6204/C3	77,-	96,-
Predator LC 50	Alle	6204/C3	77,-	77,-	6204/C3	77,-	96,-
Senda R 50	Alle	6204/C3	77,-	77,-	6204/C3	77,-	96,-
Senda SM/X-treme 50	Alle	6204/C3	77,-	77,-	6204/C3	77,-	96,-
Vamos (Morini) 50	Alle	6204/C3	77,-	77,-	6204/C3	77,-	96,-

Mærke/model	Årg.	Venstre side Varenr.	DKK	SEK	Højre side Varenr.	DKK	SEK
Märke/modell	Årg.	Vänster sida Art.nr.	DKK	SEK	Höger sida Art.nr.	DKK	SEK
FYM							
QT 50 (4 t.)	Alle	6204/C3	77,-	96,-			

Mærke/model	Årg.	Venstre side Varenr.	DKK	SEK	Højre side Varenr.	DKK	SEK
Märke/modell	Årg.	Vänster sida Art.nr.	DKK	SEK	Höger sida Art.nr.	DKK	SEK
GENERIC							
Ideo 50	Alle	6204/C3	77,-	96,-	6204/C3	77,-	96,-
Race 50	Alle	6204/C3	77,-	96,-	6204/C3	77,-	96,-
Trigger SM 50	Alle	6303/C3	68,-	68,-	6303/C3	68,-	68,-
Trigger X 50	Alle	6303/C3	68,-	68,-	6303/C3	68,-	68,-
Xor 50	Alle	6204/C3	77,-	96,-	6204/C3	77,-	96,-

Mærke/model	Årg.	Venstre side Varenr.	DKK	SEK	Højre side Varenr.	DKK	SEK
Märke/modell	Årg.	Vänster sida Art.nr.	DKK	SEK	Höger sida Art.nr.	DKK	SEK
GIANTCO							
Sprint 50	Alle	6204/C3	77,-	96,-			
Stealth 50	Alle	6204/C3	77,-	96,-			
Venus 50	Alle	6204/C3	77,-	96,-			

Mærke/model	Årg.	Venstre side Varenr.	DKK	SEK	Højre side Varenr.	DKK	SEK
Märke/modell	Årg.	Vänster sida Art.nr.	DKK	SEK	Höger sida Art.nr.	DKK	SEK
GILERA							
DNA LC 50	Alle	205212	205,-	256,-	205212	205,-	256,-
ICE AC 50	Alle	205212	205,-	256,-	205212	205,-	256,-
RCR Cross 50	Alle	6204/C3	77,-	96,-	6204/C3	77,-	96,-
Runner 50	Alle	205212	205,-	256,-	205212	205,-	256,-
Runner PJ 50	03->	205212	205,-	256,-	205212	205,-	256,-
Runner SP LC 50	02->	205212	205,-	256,-	205212	205,-	256,-
Stalker 50	Alle	205212	205,-	256,-	205212	205,-	256,-
Storm 50	Alle	205212	205,-	256,-	205212	205,-	256,-
Typhoon 50	->01	205212	205,-	256,-	205212	205,-	256,-
Typhoon-X 50	02->	205212	205,-	256,-	205212	205,-	256,-
SMT 50	Alle	6204/C3	77,-	96,-	6204/C3	77,-	96,-

Mærke/model	Årg.	Venstre side Varenr.	DKK	SEK	Højre side Varenr.	DKK	SEK
Märke/modell	Årg.	Vänster sida Art.nr.	DKK	SEK	Höger sida Art.nr.	DKK	SEK
HONDA							
Camino 50	Alle	6004M	61,-	76,-	6004M	61,-	76,-
CD 50	Alle	6304/C3	88,-	110,-	6304/C3	88,-	110,-
MB 50	Alle	62/22/C3	115,-	144,-	6204/C3	77,-	96,-
MT 50	Alle	62/22/C3	115,-	144,-	6204/C3	77,-	96,-
Melody NT 50	Alle	6204MS	218,-	273,-	6204MS	218,-	273,-
NC 50 Express	Alle	6004M	61,-	76,-	6004M	61,-	76,-
SFX 50	Alle	205612	205,-	256,-	205612	205,-	256,-
ST 50 Dax	Alle	6304/C3	88,-	88,-	6304/C3	88,-	110,-
Vision Met In 50	Alle	6203/C4	64,-	64,-	6204MS	218,-	273,-
Vision SA 50	Alle	6203/C4	64,-	64,-	6204MS	218,-	273,-
Wallaroo 50	Alle	6204MS	218,-	218,-	6204MS	218,-	273,-

Mærke/model	Årg.	Venstre side Varenr.	DKK	SEK	Højre side Varenr.	DKK	SEK
Märke/modell	Årg.	Vänster sida Art.nr.	DKK	SEK	Höger sida Art.nr.	DKK	SEK
HYOSUNG							
SB 50 M (Cab)	99->	6205/C4	79,-	79,-	6205/C4	79,-	79,-
SF 50 B (Racing)	00->	6205/C4	79,-	79,-	6205/C4	79,-	79,-
SF 50 R (Rally)	00->	6205/C4	79,-	79,-	6205/C4	79,-	79,-

Mærke/model	Årg.	Venstre side Varenr.	DKK	SEK	Højre side Varenr.	DKK	SEK
Märke/modell	Årg.	Vänster sida Art.nr.	DKK	SEK	Höger sida Art.nr.	DKK	SEK
ITALJET							
Formula 50	Alle	6204/C3	77,-	96,-			



Märke/model	Årg.	Venstre sida Varenr.			Höjre sida Varenr.		
Märke/modell	Årg.	Vänster sida Art.nr.	DKK	SEK	Höger sida Art.nr.	DKK	SEK
PEXMA							
KD 50 (4 t.)	Alle	6204/C3	77,-	96,-			
PGO							
Big Max 50	Alle	205212	205,-	256,-	205212	205,-	256,-
Black Magic 50	Alle	205212	205,-	256,-	205212	205,-	256,-
Bubu 50	Alle	205212	205,-	256,-	205212	205,-	256,-
Comet 50	Alle	205212	205,-	256,-	205212	205,-	256,-
Dr. Big 50	Alle	205212	205,-	256,-	205212	205,-	256,-
Galaxy 50	Alle	205212	205,-	256,-	205212	205,-	256,-
Hot-50	Alle	205212	205,-	256,-	205212	205,-	256,-
Ligero 50	Alle	205212	205,-	256,-	205212	205,-	256,-
PMS 50	Alle	205212	205,-	256,-	205212	205,-	256,-
PMX 50	Alle	205212	205,-	256,-	205212	205,-	256,-
Rodoshow 50	Alle	205212	205,-	256,-	205212	205,-	256,-
T-Rex 50	Alle	205212	205,-	256,-	205212	205,-	256,-
Tornado 50	Alle	205212	205,-	256,-	205212	205,-	256,-

PIAGGIO/VESPA							
ET2 50	97->	205212	205,-	256,-	205212	205,-	256,-
Fly 50	Alle	205212	205,-	256,-	205212	205,-	256,-
Free 50	Alle	205212	205,-	256,-	205212	205,-	256,-
Liberty 50	Alle	205212	205,-	256,-	205212	205,-	256,-
NRG Extreme MC3 AC 50	Alle	205212	205,-	256,-	205212	205,-	256,-
NRG Extreme MC3 LC 50	01->	205212	205,-	256,-	205212	205,-	256,-
NRG MC-2 LC 50	94->	205212	205,-	256,-	205212	205,-	256,-
Typhoon 50	Alle	205212	205,-	256,-	205212	205,-	256,-
Typhoon-X 50	02->	205212	205,-	256,-	205212	205,-	256,-
Zip 2000 50	00->	205212	205,-	256,-	205212	205,-	256,-
Zip 50	93->	205212	205,-	256,-	205212	205,-	256,-
Zip 4-Takt 50	00->	205212	205,-	256,-	205212	205,-	256,-

RIEJU							
Alle modeller 50 (m.AM-6 motor)	Alle	6303/C3	68,-	85,-	6303/C3	68,-	85,-

STRANGER							
X-fight 50 (4 t.)	Alle	6204/C3	77,-	96,-			

SUZUKI							
Adress AP-50	Alle	255213	259,-	324,-	6204/C3	77,-	96,-
DM 50 Samurai	Alle	6203/C4	64,-	80,-	6204/C3	77,-	96,-
Estilette, UF-50	Alle	255213	259,-	324,-	6204/C3	77,-	96,-
FZ-50	Alle	6204/C3	77,-	96,-	6204/C3	77,-	96,-
K 50	Alle	6204/C3	77,-	96,-	6303/C3	68,-	85,-
Katana AY-50 AC	Alle	255213	259,-	324,-	6204/C3	77,-	96,-
Katana AY-50 LC Alstare	Alle	255213	259,-	324,-	6204/C3	77,-	96,-
Katana AY-50 LC	Alle	255213	259,-	324,-	6204/C3	77,-	96,-
RMX 50	Alle	6204/C3	77,-	96,-	6204NR	79,-	99,-
SMX 50	Alle	6204/C3	77,-	96,-	6204NR	79,-	99,-
Zillion LC, UX-50	Alle	255213	259,-	324,-	6204/C3	77,-	96,-

SYM							
Jet 50	Alle	205212	205,-	256,-	255612	267,-	334,-
Super Fancy 50	Alle	205212	205,-	256,-	255612	267,-	334,-

TOBILINER							
QT 50 (4 t.)	Alle	6204/C3	77,-	96,-			

TEXAS 30/50 (4 T.)							
Chili 50 (4 t.)	Alle	6204/C3	77,-	96,-			

TGB/TOBI							
303/309 50	Alle	255213	259,-	324,-	6204/C3	77,-	96,-
Akros 50	Alle	255213	259,-	324,-	6204/C3	77,-	96,-

TMP							
Baboon 50	Alle	6204/C3	77,-	96,-	6204/C3	77,-	96,-
Gazelle 50	Alle	6204/C3	77,-	96,-	6204/C3	77,-	96,-

YAMAHA							
Aerox 50	97->	6204/C3	77,-	96,-	6204/C3	77,-	96,-
Aerox R 50	03->	6204/C3	77,-	96,-	6204/C3	77,-	96,-
Axis 50	95->	6204/C3	77,-	96,-	6204/C3	77,-	96,-
Bump 50	97->	6204/C3	77,-	96,-	6204/C3	77,-	96,-
BW's 50	Alle	6204/C3	77,-	96,-	6204/C3	77,-	96,-
BW's N.G. 50	Alle	6204/C3	77,-	96,-	6204/C3	77,-	96,-
DT-50LC	Alle	6204/C3	77,-	96,-	6204/C3	77,-	96,-
DT-50R	Alle	6204/C3	77,-	96,-	6204/C3	77,-	96,-
FS1 DX/K 50	Alle	6204/C3	77,-	96,-	6303/C3	68,-	85,-

LEJEMÅL

(tegnforklaring):

- Z:** Leje med 1 stövplade.
- 2RS:** Leje med 2 gummitætninger.
- C3:** Leje med større radialt slør.
- C4:** Leje med større radialt slør til høje omdrejninger.

Mål	Varenr.
Mått	Art.nr.
8*28*9	638Z
10*26*18	6000-2RS
10*30*9	6200-2RS
10*35*11	6300-2RS
12*28*8	6001-2RS
12*32*10	6201-2RS
12*37*12	6301-2RS
15*32*9	6002-2RS
15*35*11	6202-2RS
15*35*11	6202Z
15*42*13	6302-2RS
17*35*10	6003-2RS
17*40*12	6203/C4
17*40*12	6203-2RS
17*40*12	6203M
17*47*14	6303/C3
17*47*14	6303-2RS
20*37*9	6904-2RS
20*42*12	6004-2RS
20*42*12	6004M
20*47*12	6204MS
20*47*14	6204/C3
20*47*14	6204-2RS
20*47*14	6204M
20*47*14	6204NR
20*47*14	6204Z
20*52*12	205212
20*52*15	6304/C3
20*52*15	6304/C4
20*52*15	6304-2RS
20*52*15	6304M
20*56*12	205612
22*39*9	6922-2RS
22*44*12	6022-2RS
22*50*14	62/22/C3
22*50*14	6222-2RS
22*56*16	63/22/C3
22*56*16	63/22/C4
22*56*16	63/22-2RS
25*42*9	6905-2RS
25*47*12	6005-2RS
25*52*13	255213
25*52*15	6205/C3
25*52*15	6205/C4
25*52*15	6205-2RS
25*56*12	255612
25*62*17	6305/C3
25*62*17	6305-2RS
25*62*17	6305M
28*52*12	60/28-2RS
28*58*16	62/28-2RS
28*68*18	63/28/C3
28*68*18	63/28/C4
30*47*9	6906/2RS
30*55*13	6006-2RS
30*62*16	6206-2RS
30*64*16	830046
30*72*19	6306/C3
30*72*19	83C072C
32*65*17	62/32-2RS
32*58*13	60/32/2RS
35*55*10	6907-2RS
40*62*12	6908-2RS

Yamaha forsættes næste side ...
 Fortsætning av Yamaha på næsta sida ...

Forhandlere
 Återforsäljare
 s. 2

Stikord
 Sökord
 s. 4

Tøj/hjelme
 Kläder/
 hjälmar
 s. 6

Dæk og
 slanger
 Däck och
 slangar
 s. 15

Olje / spray
 olja / spray
 s. 26

Kæder /
 tandhjul
 Kedjor /
 drev
 s. 43

Bremsedele
 Bromsdelar
 s. 48

Låse
 Lås
 s. 93

Batteri
 Batteri
 s. 96

Cylinder /
 topstykke
 Cylinder /
 topplock
 s. 105

Motordele
 Motordele
 s. 137

Karburator -
 Luftfilter
 Förgasare -
 Luftfilter
 s. 208

El-dele
 tændrør
 Elektriskt
 tändstift
 s. 222

Udstødning
 Avgassystem
 s. 246

Forgaffel
 Støddæmpere
 Framgaffel
 Støtdämpare
 s. 260

Kabler
 Wire
 s. 266

Styr og
 greb
 Styre och
 handtag
 s. 272





Spejle
 Speglar
 s. 282

Blinklygter
 Baglygter
 Blinkers
 Baklykte
 s. 284

Støtteben
 Topboks, mm.
 Stödd
 Topbbox, mm
 s. 291

Rep. bøger
 værktøj
 Rep. böcker
 Verktyg
 s. 297



Mærke/model	Årg.	Venstre side Varenr.			Højre side Varenr.		
Mærke/modell	Årg.	Vänster sida Art.nr.	 DKK	 SEK	Höger sida Art.nr.	 DKK	 SEK
YAMAHA							
Jog, Artistic-Fine Selection 50	Alle	6204/C3	77,-	96,-	6204/C3	77,-	96,-
Jog Space Innovacion, YV-50	98->	6204/C3	77,-	96,-	6204/C3	77,-	96,-
Neo's 50	97->	6204/C3	77,-	96,-	6204/C3	77,-	96,-
Passola 50	Alle	6203/C4	64,-	80,-	6203/C4	64,-	80,-
Jog-RR (LC) 50	03->	6204/C3	77,-	96,-	6204/C3	77,-	96,-
Jog-R (AC) 50	03->	6204/C3	77,-	96,-	6204/C3	77,-	96,-
Slider 50	01->	6204/C3	77,-	96,-	6204/C3	77,-	96,-
Spy 50	Alle	6204/C3	77,-	96,-	6204/C3	77,-	96,-
Sting 50	Alle	6203/C4	64,-	80,-	6203/C4	64,-	80,-
TZR 50 R	Alle	6303/C3	68,-	85,-	6303/C3	68,-	85,-
Why 50	99->	6204/C3	77,-	96,-	6204/C3	77,-	96,-



Beta
the play bike

MADE IN ITALY!

MAX
MOTORBIKES

Læs mere på www.betamotor.dk



R 10 MINIMOTO

- STEL:** Stålstel.
- MOTOR:** Franco Morini.
Luftkølet. En 49 cc cylinder.
To-takt. Dell'Orto karburator.
Slyngkobling.
- HJUL:** For: 12" / 160 mm. bremseskive.
Bag: 10" / 90 mm. tromle.
- LÆNGDE:** 1290 mm.
- BREDDE:** 590 mm.
- SÆDEHØJDE:** 620 mm.
- TØRVÆGT:** 37,5 kg.
- FORGAFFEL:** 30 mm. mekanisk.



12.998,-

Ekskl. leveringsomkostninger

Beta anbefaler
Silkolene
olie!

Importør: **SCANMI** Tlf. +45 73 15 11 00

Design og produktion  100 % italiensk!

MÆRKE/MODEL	ÅRG.	Varenr.		
MÄRKE/MODELL	ÅRG.	Art.NR.	 DKK	 SEK
GILERA				
Runner AC 50	Alle	110001	209,-	261:-
Runner LC 50	Alle	110001	209,-	261:-
Stalker 50	Alle	110001	209,-	261:-
HONDA				
Wallaroo 50	Alle	110003	209,-	261:-
PEUGEOT				
Buxy 50	94->	110004	209,-	261:-
Elyseo 50	Alle	110004	209,-	261:-
Fox 25 50	03->	110003	209,-	261:-
Speedake 50	95->	110004	209,-	261:-
Speedfight AC 50	95->	110004	209,-	261:-
Speedfight LC 50	Alle	110004	209,-	261:-
Squab 50	95->	110004	209,-	261:-
Trekker 50	98->	110004	209,-	261:-
Trekker/Metal X 50	03->	110004	209,-	261:-
Zenith 50	94->	110004	209,-	261:-



 MØTRIK TIL
BAGHJULSAKSEL
 LÅSMUTTER
FÖR BAKHJULSAXEL

Passer til Aprilia /
Yamaha (Minarelli)
Varenr. 110080

 DKK  SEK
41,- 51:-

MAX
MC Parts



Forhandlere
Återförsäljare
s. 2

Stikord
Sökord
s. 4

Tøj/hjelme
Kläder/
hjälmår
s. 6

Dæk og
slanger
Däck och
slangor
s. 15

Olje / spray
Olja / spray
s. 26

Kæder /
tandhjul
Kedjor /
drev
s. 43

Bremsedele
Bromsdelar
s. 48

Låse
Lås
s. 93

Batteri
Batteri
s. 96

Cylinder /
topstykke
Cylinder /
topplöck
s. 105

Motordele
Motordeelar
s. 137

Karburator
- Luftfilter
Förgasare
- Luftfilter
s. 208

El-dele
tændrør
Elektriskt
tändstift
s. 222

Udstødning
Avgassystem
s. 246

Forgaffel
Støddæmpere
Framgaffel
Stötdämpare
s. 260

Kabler
Wire
s. 266

Styr og
greb
Styre och
handtag
s. 272



Spejle
Speglar
s. 282

Blinklygter
Baglygter
Blinkers
Baklykte
s. 284

Støtteben
Topboks, mm.
Stödd
Toppbox, mm
s. 291

Rep. bøger
værktøj
Rep. böcker
Verktyg
s. 297



MÆRKE/MODEL	ÅRG.	Varenr.		
MÆRKE/MODELL	ÅRG.	Art.NR.	 DKK	 SEK
ADLY				
Cat 50	Alle	101500	249,-	311,-
Jet 50	Alle	101500	249,-	311,-
Silver Fox 50	Alle	101500	249,-	311,-
Super Sonic 50	Alle	101500	249,-	311,-
Thunder Bike 50	Alle	101500	249,-	311,-
APRILIA				
Amico 50	Alle	101500	249,-	311,-
Area 51 LC 50	98->	101500	249,-	311,-
Gulliver AC 50	Alle	101500	249,-	311,-
Rally AC 50	Alle	101500	249,-	311,-
RX 50	07->	101508	249,-	311,-
Scarabeo AC 50	Alle	101500	249,-	311,-
Sonic AC 50	Alle	101500	249,-	311,-
Sonic LC 50	Alle	101500	249,-	311,-
SR - www AC 50	97->	101500	249,-	311,-
SR-50 AC	Alle	101500	249,-	311,-
SR-Racing 50, Stealth, Netscaper LC	Alle	101500	249,-	311,-
SR-Replica LC (Minarelli) 50	->00	101500	249,-	311,-
SX 50	07->	101508	249,-	311,-
ATALA				
Carosello 50	Alle	101500	249,-	311,-
BENELLI				
491 GT 50	97->	101500	249,-	311,-
491 Sport 50	97->	101500	249,-	311,-
K2/LC 50	Alle	101500	249,-	311,-
BETA				
Ark AC 50	Alle	101500	249,-	311,-
Ark/LC 50	Alle	101500	249,-	311,-
CPI				
Aragon 50 (Euro 2)	Alle	101511	249,-	311,-
Formula R 50 (Euro 2)	Alle	101511	249,-	311,-
Hussar 50	Alle	101511	249,-	311,-
Oliver/City 50 (Euro 2)	Alle	101511	249,-	311,-
Popcorn 50	Alle	101511	249,-	311,-
DERBI				
Atlantis 50 AC	Alle	101507	249,-	311,-
Atlantis 50 LC	Alle	101507	249,-	311,-
GP-1 50	Alle	101507	249,-	311,-
GPR 50	Alle	101508	249,-	311,-
Hunter 50	Alle	101507	249,-	311,-
Manhattan 50	Alle	101507	249,-	311,-
Paddock 50	Alle	101507	249,-	311,-
Predator 50	Alle	101507	249,-	311,-
Senda 50	Alle	101508	249,-	311,-
GENERIC				
Ideo 50	Alle	101511	249,-	311,-
Trigger SM 50	Alle	101511	249,-	311,-
Xor 50	Alle	101511	249,-	311,-
GILERA				
DNA LC 50	Alle	101503	249,-	311,-
ICE AC 50	Alle	101503	249,-	311,-
RCR Cross 50	Alle	101503	249,-	311,-
Runner AC 50	Alle	101503	249,-	311,-
Runner LC 50	Alle	101503	249,-	311,-
Runner SP LC 50	02->	101503	249,-	311,-
Stalker 50	Alle	101503	249,-	311,-
Storm 50	Alle	101503	249,-	311,-
Typhoon 50	->01	101503	249,-	311,-
Typhoon-X 50	02->	101503	249,-	311,-
SMT 50	Alle	101508	249,-	311,-
HONDA				
SFX 50	Alle	101505	249,-	311,-
SGX 50	Alle	101506	249,-	311,-
Sky 50	Alle	101506	249,-	311,-
Vision Met In 50	Alle	101502	249,-	311,-
Vision SA 50	Alle	101502	249,-	311,-
Wallaroo 50	Alle	101501	249,-	311,-
X8R 50	Alle	101506	249,-	311,-
ITALJET				
Dragster 50 LC	Alle	101500	249,-	311,-
KEEWAY				
F-act 50	Alle	101511	249,-	311,-
Flash 50	Alle	101511	249,-	311,-

MÆRKE/MODEL	ÅRG.	Varenr.		
MÆRKE/MODELL	ÅRG.	Art.NR.	 DKK	 SEK
KEEWAY				
Focus 50	Alle	101511	249,-	311,-
Matrix 50	Alle	101511	249,-	311,-
KREIDLER				
Easy Rider 50	Alle	101500	249,-	311,-
MALAGUTI				
F10 AC 50	Alle	101500	249,-	311,-
F12 Phantom AC 50	Alle	101500	249,-	311,-
F15 Firefox LC 50	Alle	101500	249,-	311,-
PEUGEOT				
Buxy 50	94->	101504	249,-	311,-
Elyseo 50	Alle	101504	249,-	311,-
Elystar 50	Alle	101504	249,-	311,-
Fox 50	Alle	101504	249,-	311,-
Looxor 50	Alle	101504	249,-	311,-
Ludix 50 One	Alle	101504	249,-	311,-
Speedake 50	95->	101504	249,-	311,-
Speedfight 2 AC 50	Alle	101504	249,-	311,-
Speedfight 3 50	Alle	101504	249,-	311,-
Speedfight AC 50	95->	101504	249,-	311,-
Speedfight LC 50	Alle	101504	249,-	311,-
Squab 50	95->	101504	249,-	311,-
TKR 50	Alle	101504	249,-	311,-
Trekker 50	98->	101504	249,-	311,-
Trekker/Metal X 50	03->	101504	249,-	311,-
Vivacity 50	Alle	101504	249,-	311,-
Zenith 50	94->	101504	249,-	311,-
PGO				
Big Max 50	Alle	101510	249,-	311,-
Black Magic 50	Alle	101510	249,-	311,-
Bubu 50	Alle	101510	249,-	311,-
Comet 50	Alle	101510	249,-	311,-
Dr. Big 50	Alle	101510	249,-	311,-
Galaxy 50	Alle	101510	249,-	311,-
G-Max 50	Alle	101510	249,-	311,-
Hot 50	Alle	101510	249,-	311,-
Ligero 50	Alle	101510	249,-	311,-
PMS 50	Alle	101510	249,-	311,-
PMX 50	Alle	101510	249,-	311,-
Rodoshow 50	Alle	101510	249,-	311,-
Streetfighter 50	Alle	101510	249,-	311,-
T-Rex 50	Alle	101510	249,-	311,-
Tornado 50	Alle	101510	249,-	311,-
PIAGGIO/VESPA				
ET2 50	97->	101503	249,-	311,-
Fly 50	Alle	101503	249,-	311,-
Free 50	Alle	101503	249,-	311,-
Liberty 50	Alle	101503	249,-	311,-
NRG Extreme MC3 AC 50	Alle	101503	249,-	311,-
NRG Extreme MC3 LC 50	01->	101503	249,-	311,-
NRG MC-2 LC 50	94->	101503	249,-	311,-
Typhoon 50	Alle	101503	249,-	311,-
Typhoon-X 50	Alle	101503	249,-	311,-
Zip 2000 50	00->	101503	249,-	311,-
Zip 50	93->	101503	249,-	311,-
TMP				
Baboon 50	Alle	101500	249,-	311,-
Gazelle 50	Alle	101500	249,-	311,-
YAMAHA				
Aerox 50	97->	101500	249,-	311,-
Axis 50	95->	101500	249,-	311,-
Bump 50	97->	101500	249,-	311,-
BW's 50	->96	101500	249,-	311,-
BW's N.G. 50	96->	101500	249,-	311,-
DT 50 LC	Alle	101509	249,-	311,-
DT 50 MX	Alle	101509	249,-	311,-
Jog Artistic - Fine Selection 50	Alle	101500	249,-	311,-
Jog Space Innovacion 50	98->	101500	249,-	311,-
Jog-R (AC) 50	03->	101500	249,-	311,-
Jog-RR (LC) 50	03->	101500	249,-	311,-
Neo's 50	97->	101500	249,-	311,-
Slider 50	01->	101500	249,-	311,-
Spy 50	Alle	101500	249,-	311,-



Forhandlere
Återförsäljare
s. 2

Stikord
Sökord
s. 4

Tøj/hjelme
Kläder/
hjälm
s. 6

Dæk og
slanger
Däck och
slangar
s. 15

Olje / spray
olja / spray
s. 26

Kæder /
tandhjul
Kedjor /
drev
s. 43

Bremsedele
Bromsdelar
s. 48

Låse
Lås
s. 93

Batteri
Batteri
s. 96

Cylinder /
topstykke
Cylinder /
toplock
s. 105

Motordele
Motordele
s. 137

Karburator -
Luftfilter
Förgasare -
Luftfilter
s. 208

El-dele
tændrør
Elektriskt
tändstift
s. 222

Udstødning
Avgassystem
s. 246

Forgaffel
Støddæmpere
Framgaffel
Støddæmpare
s. 260

Kabler
Wire
s. 266

Styr og
greb
Styre och
handtag
s. 272

Spejle
Speglar
s. 282

Blinklygter
Baglygter
Blinkers
Baklykte
s. 284

Støtteben
Topboks, mm.
Stödd
Topbbox, mm
s. 291

Rep. bøger
værktøj
Rep. böcker
Verktyg
s. 297



Mærke/model	Årg.	Forhjul Antal x varenr.	Stk. DKK	Stk. SEK	BaghjulStk. Antal x varenr.	Stk. DKK	Stk. SEK
Mærke/modell	Årg.	Framhjul Antal x art.nr.	St. DKK	St. SEK	BakhjulSt. Antal x art.nr.	St. DKK	St. SEK

ADLY

50 cc	Alle	2 x 6300-2RS	75,-	94,-			
-------	------	--------------	------	------	--	--	--

APRILIA

Amigo LX/GL 50	Alle	2 x 6201-2RS	61,-	76,-			
Area 51 50	Alle	2 x 6203-2RS	79,-	99,-			
Classic 50	Alle	2 x 6201-2RS	61,-	76,-			
Rally 50	Alle	2 x 6201-2RS	61,-	76,-			
RS 50	Alle	2 x 6202-2RS	67,-	84,-			
Scarabeo 50	Alle	2 x 6201-2RS	61,-	76,-			
SR 50	Alle	2 x 6201-2RS	61,-	76,-			
SR 50 Ditech 50	Alle	2 x 6202-2RS	67,-	76,-			

CPI

Popcorn 50	Alle	2 x 6201-2RS	61,-	76,-			
------------	------	--------------	------	------	--	--	--

DERBI

Hunter 50	Alle	2 x 6201-2RS	61,-	76,-			
Predator LC 50	Alle	2 x 6201-2RS	61,-	76,-			
Paddock LC 50	Alle	2 x 6201-2RS	61,-	76,-			
Senda R/Offroad 50	Alle	2 x 6201-2RS	61,-	76,-	2 x 6201-2RS	61,-	76,-
Vamos 50	Alle	2 x 6201-2RS	61,-	76,-			

HONDA

CD 50	Alle	2 x 6300-2RS	75,-	94,-	2 x 6301-2RS	82,-	103,-
ST 50 Dax	Alle	2 x 6301-2RS	82,-	103,-	2 x 6301-2RS	103,-	103,-
NC 50 Express	Alle	2 x 6200-2RS	64,-	80,-			
Melody 50	Alle	2 x 6200-2RS	64,-	80,-	2 x 6202-2RS	67,-	84,-
Wallaro PK 50	Alle	2 x 6200-2RS	64,-	80,-			
Vision 50	Alle	2 x 6200-2RS	64,-	80,-	1 x 6202-2RS / 1 x 6203-2RS	67,-	84,-
X8-R 50	Alle	2 x 6201-2RS	61,-	76,-			

PGO

Comet 50	Alle	2 x 6200-2RS	61,-	76,-			
Galaxy 50	Alle						
Hot 50	Alle	2 x 6201-2RS	61,-	76,-			
T-Rex 50	Alle	2 x 6201-2RS	61,-	76,-			
PMS 50	Alle	2 x 6201-2RS	61,-	76,-			
Rodoshow 50	Alle	2 x 6201-2RS	61,-	76,-			

SUZUKI

K 50 B	Alle	1 x 6300-2RS /	75,-	94,-			
		1 x 6200-2RS	64,-	80,-	2 x 6301-2RS	82,-	103,-
K 50 DB	Alle	2 x 6300-2RS	75,-	94,-	2 x 6301-2RS	82,-	103,-
		1 x 6200-2RS /	64,-	80,-			
FZ 50 Suzy	Alle	1 x 6000-2RS /	79,-	99,-	2 x 6302-2RS	82,-	103,-
		1 x 6200-2RS /	64,-	80,-			
FZ 50 Suzy	Alle	1 x 6000-2RS	79,-	80,-	2 x 6203-2RS	79,-	99,-
		1 x 6000-2RS	79,-	99,-	2 x 6001-2RS	75,-	94,-
DM 50 X Samurai	Alle	2 x 6000-2RS	64,-	80,-	1 x 6204-2RS	87,-	109,-
AP 50 Adress	Alle	2 x 6200-2RS	64,-	80,-			
Katana AC/LC 50	Alle	2 x 6200-2RS	64,-	80,-			
TR 50 Street Magic	Alle	2 x 6200-2RS	64,-	80,-			
UF 50 Estilete	Alle	2 x 6200-2RS	64,-	80,-			
RMX 50	Alle	2 x 6200-2RS	64,-	80,-	2 x 6201-2RS	61,-	76,-
UX 50 W Zillion	Alle	2 x 6200-2RS	64,-	80,-			

YAMAHA

Aerox 50	Alle	2 x 6300-2RS	75,-	94,-			
Axis 50	Alle	2 x 6300-2RS	75,-	94,-			
Bump 50	Alle	2 x 6300-2RS	75,-	94,-			
BW's 50	Alle	2 x 6300-2RS	75,-	94,-	1 x 6203-2RS	79,-	99,-
BW's N.G. 50	Alle	2 x 6300-2RS	75,-	94,-	1 x 6203-2RS	79,-	99,-
CY 50 Jog 30 kmt	Alle	2 x 6200-2RS	64,-	80,-	1 x 6203-2RS	79,-	99,-
CY 50 Jog 45 kmt	Alle	2 x 6200-2RS	64,-	80,-	1 x 6203-2RS	79,-	99,-
DX 50, 4 gear	Alle	2 x 6301-2RS	82,-	103,-	2 x 6301-2RS	82,-	103,-
FS1 50, 4 gear	Alle	2 x 6300-2RS	75,-	94,-	2 x 6301-2RS	82,-	103,-
FS1 50, 2 gear	Alle	2 x 6200-2RS	64,-	80,-	2 x 6201-2RS	61,-	76,-
Neos 50	Alle	2 x 6300-2RS	75,-	94,-			
Pasola SA-50	Alle	2 x 6200-2RS	64,-	80,-	1 x 6202-2RS	67,-	84,-
SG 50 Sting	Alle	2 x 6200-2RS	64,-	80,-	1 x 6202-2RS / 1 x 6202-2RS	67,-	84,-
Spy 50	Alle	2 x 6300-2RS	75,-	94,-			
TZR 50 R	97->	2 x 6301-2RS	82,-	103,-	1 x 6302-2RS / 1 x 6202-2RS	82,-	103,-

LEJEMÅL

(tegnforklaring):

- Z:** Leje med 1 støvplade.
- 2RS:** Leje med 2 gummitætninger.
- C3:** Leje med større radialt slør.
- C4:** Leje med større radialt slør til høje omdrejninger.

Mål	Varenr.
-----	---------

Mått	Art.nr.
8*28*9	638Z
10*26*18	6000-2RS
10*30*9	6200-2RS
10*35*11	6300-2RS
12*28*8	6001-2RS
12*32*10	6201-2RS
12*37*12	6301-2RS
15*32*9	6002-2RS
15*35*11	6202-2RS
15*35*11	6202Z
15*42*13	6302-2RS
17*35*10	6003-2RS
17*40*12	6203/C4
17*40*12	6203-2RS
17*40*12	6203M
17*47*14	6303/C3
17*47*14	6303-2RS
20*37*9	6904-2RS
20*42*12	6004-2RS
20*42*12	6004M
20*47*12	6204MS
20*47*14	6204/C3
20*47*14	6204-2RS
20*47*14	6204M
20*47*14	6204NR
20*47*14	6204Z
20*52*12	205212
20*52*15	6304/C3
20*52*15	6304/C4
20*52*15	6304-2RS
20*52*15	6304M
20*56*12	205612
22*39*9	6922-2RS
22*44*12	6022-2RS
22*50*14	62/22/C3
22*50*14	6222-2RS
22*56*16	63/22/C3
22*56*16	63/22/C4
22*56*16	63/22-2RS
25*42*9	6905-2RS
25*47*12	6005-2RS
25*52*13	255213
25*52*15	6205/C3
25*52*15	6205/C4
25*52*15	6205-2RS
25*56*12	255612
25*62*17	6305/C3
25*62*17	6305-2RS
25*62*17	6305M
28*52*12	60/28-2RS
28*58*16	62/28-2RS
28*68*18	63/28/C3
28*68*18	63/28/C4
30*47*9	6906/2RS
30*55*13	6006-2RS
30*62*16	6206-2RS
30*64*16	830046
30*72*19	6306/C3
30*72*19	83C072C
32*65*17	62/32-2RS
32*58*13	60/32/2RS
35*55*10	6907-2RS
40*62*12	6908-2RS



Mærke/model	Årg.	Variator komplet Varenr.	Bagplade Varenr.	Blæserhjul Varenr.							
Mærke/model	Årg.	Variator komplett Art.nr.	DKK	SEK	Bakplatta Art.nr.	DKK	SEK	Blæserhjul Art.nr.	DKK	SEK	
ADLY											
Cat 50	Alle	034401	399,-	499,-	034450	131,-	164,-	034500	93,-	116,-	
Jet 50	Alle	034401	399,-	499,-	034450	131,-	164,-	034500	93,-	116,-	
Silver Fox 50	Alle	034401	399,-	499,-	034450	131,-	164,-	034500	93,-	116,-	
Super Sonic 50	Alle	034401	399,-	499,-	034450	131,-	164,-	034500	93,-	116,-	
Thunder Bike 50	Alle	034401	399,-	499,-	034450	131,-	164,-	034500	93,-	116,-	
APRILIA											
Amico 50	Alle	034400	399,-	499,-	034450	131,-	164,-	034500	93,-	116,-	
Area 51 LC	98->	034401	399,-	499,-	034450	131,-	164,-	034500	93,-	116,-	
Gulliver 50	Alle	034401	399,-	499,-	034450	131,-	164,-	034500	93,-	116,-	
Habana AC (Morini) 50	Alle	034402	399,-	499,-	034451	131,-	164,-				
Rally AC 50	Alle	034401	399,-	499,-	034450	131,-	164,-	034500	93,-	116,-	
Scarabeo 50	Alle	034401	399,-	499,-	034452	131,-	164,-	034500	93,-	116,-	
Scarabeo Ditech (Morini) 50	02->	034402	399,-	499,-	034452	131,-	164,-				
Sonic AC 50	Alle	034401	399,-	499,-	034450	131,-	164,-	034500	93,-	116,-	
Sonic LC 50	Alle	034401	399,-	499,-	034450	131,-	164,-	034500	93,-	116,-	
SR - Ditech (Morini) 50	Alle	034402	399,-	499,-	034451	131,-	164,-				
SR - www AC 50	97->	034401	399,-	499,-	034453	131,-	164,-	034500	93,-	116,-	
SR-50 AC 50	->96	034401	399,-	499,-	034453	131,-	164,-	034500	93,-	116,-	
SR-Racing 50, Stealth, Netscaper LC	Alle	034401	399,-	499,-	034453	131,-	164,-	034500	93,-	116,-	
SR-Replica LC (Minarelli) 50	->00	034401	399,-	499,-	034453	131,-	164,-	034500	93,-	116,-	
SR-Replica-2000 LC (Morini) 50	00->	034402	399,-	499,-	034451	131,-	164,-				
ATALA											
Carosello 50	Alle	034401	399,-	499,-	034452	131,-	164,-	034500	93,-	116,-	
Hacker AT-12 50	Alle	034402	399,-	499,-	034454	131,-	164,-				
Hacker LC 50	Alle	034402	399,-	499,-	034454	131,-	164,-				
Skeggia 50	Alle	034402	399,-	499,-	034454	131,-	164,-				
AVANTI											
9 N 50 (4 t.)	Alle	034413	269,-	336,-				034506	49,-	61,-	
Sport Classic 50 (4 t.)	Alle	034413	269,-	336,-				034506	49,-	61,-	
Eagle 50 (4 t.)	Alle	034413	269,-	336,-				034506	49,-	61,-	
Avanti Wolf 50 (4 t.)	Alle	034413	269,-	336,-				034506	49,-	61,-	
BAOTAIN											
BT49QT-7 50 (4 t.)	Alle	034413	269,-	336,-				034506	49,-	61,-	
BT49QT-9 50 (4 t.)	Alle	034413	269,-	336,-				034506	49,-	61,-	
BT49QT-11 50 (4 t.)	Alle	034413	269,-	336,-				034506	49,-	61,-	
BT49QT-12C 50 (4 t.)	Alle	034413	269,-	336,-				034506	49,-	61,-	
BT49QT-12 50 (4 t.)	Alle	034413	269,-	336,-				034506	49,-	61,-	
BENDA											
Scoot 50 (4 t.)	Alle	034413	269,-	336,-				034506	49,-	61,-	
BENELLI											
491 GT 50	97->	034401	399,-	499,-	034450	131,-	164,-	034500	93,-	116,-	
491 Sport 50	97->	034401	399,-	499,-	034452	131,-	164,-	034500	93,-	116,-	
K2/LC 50	Alle	034401	399,-	499,-	034452	131,-	164,-	034500	93,-	116,-	
BETA											
Ark AC 50	Alle	034401	399,-	499,-	034453	131,-	164,-	034500	93,-	116,-	
Ark LC 50	Alle	034401	399,-	499,-	034453	131,-	164,-	034500	93,-	116,-	
CAGIVA											
City 50	Alle	034403	399,-	499,-	034455	131,-	164,-				
CPI											
Aragon 50 (Euro 2)	Alle	034411	399,-	499,-				034504	134,-	168,-	
ATV 50 cc	Alle	034411	399,-	499,-				034504	134,-	168,-	
Formula R 50 (Euro 2)	Alle	034411	399,-	499,-				034504	134,-	168,-	
Hussar 50	Alle	034411	399,-	499,-				034504	134,-	168,-	
Oliver/City 50 (Euro 2)	03->	034411	399,-	499,-				034504	134,-	168,-	
Popcorn 50	Alle	034411	399,-	499,-				034504	134,-	168,-	
DERBI											
Atlantis 50	03->							110061	91,-	114,-	
GP1 50	03->							110061	91,-	114,-	
Hunter 50	Alle							110061	91,-	114,-	
Manhattan 50	Alle							110061	91,-	114,-	
Paddock 50	Alle							110061	91,-	114,-	
Predator 50	Alle							110061	91,-	114,-	
Vamos (Morini) 50	Alle	034402	399,-	499,-	034456	131,-	164,-				
FYM											
QT 50	Alle	034413	269,-	336,-				034506	49,-	61,-	
GENERIC											
Ideo 50	Alle	034411	399,-	499,-				034504	134,-	168,-	
Race 50	Alle	034411	399,-	499,-				034504	134,-	168,-	
Xor 50	Alle	034411	399,-	499,-				034504	134,-	168,-	

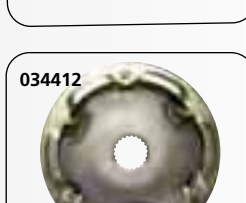
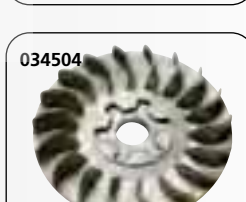
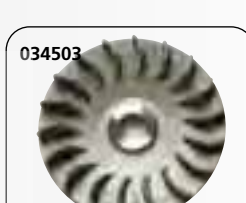
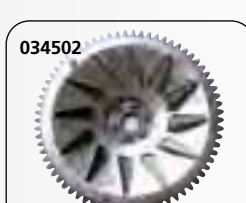
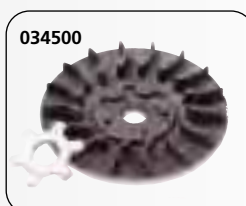

VARIATOR KOMPLETT
VARIATOR KOMPLETT



Märke/model	Årg.	Variator komplett Varenr.	DKK		SEK		Blåserhjul Varenr.	DKK		SEK	
Märke/modell	Årg.	Variator komplett Art.nr.	DKK	SEK	Bakplatta Art.nr.	DKK	SEK	Blåserhjul Art.nr.	DKK	SEK	SEK
GIANTCO											
G-Buddy 50 (4 t.)	Alle	034413	269,-	336,-				034506	49,-	61,-	
Sprint 50 (4 t.)	Alle	034413	269,-	336,-							
Stealth 50 (4 t.)	Alle	034413	269,-	336,-							
Venus 50 (4 t.)	Alle	034413	269,-	336,-							

GILERA

DNA LC 50	Alle	034405	399,-	499,-	034457	131,-	164,-	034501	198,-	248,-	
ICE AC 50	Alle	034405	399,-	499,-	034457	131,-	164,-	034501	198,-	248,-	
Runner AC 50	Alle	034405	399,-	499,-	034457	131,-	164,-	034501	198,-	248,-	
Runner LC 50	Alle	034405	399,-	499,-	034457	131,-	164,-	034501	198,-	248,-	
Runner PJ 50	03->	034405	399,-	499,-	034457	131,-	164,-	034501	198,-	248,-	
Runner SP LC 50	02->	034405	399,-	499,-	034457	131,-	164,-	034501	198,-	248,-	
Stalker 50	Alle	034405	399,-	499,-	034457	131,-	164,-	034501	198,-	248,-	
Storm 50	Alle	034405	399,-	499,-	034457	131,-	164,-	034501	198,-	248,-	
Typhoon 50	Alle	034405	399,-	499,-	034457	131,-	164,-	034501	198,-	248,-	
Typhoon-X 50	02->	034405	399,-	499,-	034457	131,-	164,-	034501	198,-	248,-	

HONDA

SFX 50	Alle	034406	399,-	499,-	034458	131,-	164,-				
Sky 50	Alle	034406	399,-	499,-	034458	131,-	164,-				
Vision Met In 50	Alle	034407	399,-	499,-	034459	131,-	164,-				
Vision SA 50	Alle	034407	399,-	499,-	034459	131,-	164,-				
Wallaroo 50	Alle	034407	399,-	499,-	034460	131,-	164,-				
X8-R 50	Alle	034406	399,-	499,-	034461	131,-	164,-				

HOOPER

One 50 (4 t.)	Alle	034413	269,-	336,-				034506	49,-	61,-	
---------------	------	--------	-------	-------	--	--	--	--------	------	------	--

HYOSUNG

SB 50 M (Cab)	Alle	034402	399,-	499,-				034505	95,-	119,-	
SF 50 B (Racing)	Alle	034402	399,-	499,-				034505	95,-	119,-	
SF 50 R (Rally)	Alle	034402	399,-	499,-				034505	95,-	119,-	

ITALJET

Formula 50	Alle	034402	399,-	499,-	034454	131,-	164,-				
Velocifero 50	Alle	034402	399,-	499,-	034462	131,-	164,-				

KEEWAY

F-act 50	Alle	034411	399,-	499,-				034504	134,-	168,-	
Flash 50	Alle	034411	399,-	499,-				034504	134,-	168,-	
Focus 50	Alle	034411	399,-	499,-				034504	134,-	168,-	
Matrix 50	Alle	034411	399,-	499,-				034504	134,-	168,-	

KREIDLER

Easy Rider 50	Alle				034450	131,-	164,-	034500	93,-	116,-	
---------------	------	--	--	--	--------	-------	-------	--------	------	-------	--

KYMCO

Agility 50 (4 t.)	Alle	034413	269,-	336,-							
K-12 50	Alle	034408	399,-	499,-	034463	131,-	164,-				
NZ-50 Super Fever 50	03->	034408	399,-	499,-	034463	131,-	164,-				
Super 8 50 (4 t.)	Alle	034413	269,-	336,-				034506	49,-	61,-	

MALAGUTI

F10 AC 50	Alle	034401	399,-	499,-	034450	131,-	164,-	034500	93,-	116,-	
F12 Phantom AC 50	Alle	034401	399,-	499,-	034450	131,-	164,-	034500	93,-	116,-	
F15 Firefox LC 50	Alle	034401	399,-	499,-	034450	131,-	164,-	034500	93,-	116,-	

PEUGEOT

Buxy 50	94->	034406	399,-	499,-	034461	131,-	164,-	034502	289,-	361,-	
Elyseo 50	98->	034406	399,-	499,-	034458	131,-	164,-	034502	289,-	361,-	
Elystar 50	Alle	034406	399,-	499,-							
Fox 25 50	03->	034406	399,-	499,-				034502	289,-	361,-	
Looxor 50	Alle	034406	399,-	499,-				034502	289,-	361,-	
Ludix 50 One	Alle	034406	399,-	499,-				034502	289,-	361,-	
Speedake 50	95->	034406	399,-	499,-	034461	131,-	164,-	034502	289,-	361,-	
Speedfight -2 AC 50	Alle	034406	399,-	499,-	034458	131,-	164,-	034502	289,-	361,-	
Speedfight AC 50	95->	034406	399,-	499,-	034458	131,-	164,-	034502	289,-	361,-	
Speedfight LC 50	Alle	034406	399,-	499,-	034458	131,-	164,-	034502	289,-	361,-	
Squab 50	95->	034406	399,-	499,-	034458	131,-	164,-	034502	289,-	361,-	
TKR 50	Alle	034406	399,-	499,-				034502	289,-	361,-	
Trekker 50	98->	034406	399,-	499,-	034461	131,-	164,-	034502	289,-	361,-	
Trekker/Metal X 50	03->	034406	399,-	499,-	034461	131,-	164,-	034502	289,-	361,-	
V-Clic 50 (4 t.)	Alle	034413	269,-	336,-				034506	49,-	61,-	
Vivacity 50	Alle	034406	399,-	499,-	034458	131,-	164,-	034502	289,-	361,-	
Zenith 50	94->	034406	399,-	499,-	034461	131,-	164,-	034502	289,-	361,-	







PEXMA

KDQT 50 (4 t.)	Alle	034413	269,-	336,-							
----------------	------	--------	-------	-------	--	--	--	--	--	--	--



- Forhandlere
Återförsäljare
s. 2
- Stikord
Sökord
s. 4
- Tøj/hjelme
Kläder/
hjälm
s. 6
- Däck og
slanger
Däck och
slangar
s. 15
- Olje / spray
Olja / spray
s. 26
- Kæder /
tandhjul
Kedjor /
drev
s. 43
- Bremsedele
Bromsdelar
s. 48
- Låse
Lås
s. 93
- Batteri
Batteri
s. 96
- Cylinder /
topstykke
Cylinder /
topplöck
s. 105
- Motordele
Motordele
s. 137
- Karburator
- Luftfilter
Förgasare
- Luftfilter
s. 208
- El-dele
tændrør
Elektriskt
tändstift
s. 222
- Udstødning
Avgassystem
s. 246
- Forgaffel
Støddæmpere
Framgaffel
Støtdæmpere
s. 260
- Kabler
Wire
s. 266
- Styr og
greb
Styre och
handtag
s. 272
- Spejle
Speglar
s. 282
- Blinklygter
Baglygter
Blinkers
Baklykte
s. 284
- Støtteben
Topboks, mm.
Stödd
Topbbox, mm
s. 291
- Rep. bøger
værktøj
Rep. böcker
Verktyg
s. 297



Mærke/model	Årg.	Variator komplet Varenr.			Bagplade Varenr.			Blåserhjul Varenr.			Variomatikhuss u/bøsning Varenr.		
Mærke/model	Årg.	Art.nr.			Art.nr.			Art.nr.			Art.nr.		
PGO													
Big Max 50	Alle	034409	399,-	499,-	034463	131,-	164,-	034503	95,-	119,-			
Black Magic 50	Alle	034409	399,-	499,-	034463	131,-	164,-	034503	95,-	119,-			
Bubu 50	Alle	034409	399,-	499,-	034463	131,-	164,-	034503	95,-	119,-			
Comet 50	Alle	034410	399,-	499,-	034463	131,-	164,-	034503	95,-	119,-			
Dr. Big 50	Alle	034409	399,-	499,-	034463	131,-	164,-	034503	95,-	119,-			
Galaxy 50	Alle	034409	399,-	499,-	034463	131,-	164,-	034503	95,-	119,-			
G-Max 50	Alle	034409	399,-	499,-	034463	131,-	164,-	034503	95,-	119,-			
Hot-50	Alle	034409	399,-	499,-	034463	131,-	164,-	034503	95,-	119,-			
Ligero 50	Alle	034409	399,-	499,-	034463	131,-	164,-	034503	95,-	119,-			
PMS 50	Alle	034409	399,-	499,-	034463	131,-	164,-	034503	95,-	119,-			
PMX 50	Alle	034409	399,-	499,-	034463	131,-	164,-	034503	95,-	119,-			
Rodoshow 50	Alle	034409	399,-	499,-	034463	131,-	164,-	034503	95,-	119,-			
Streetfighter 50	Alle	034409	399,-	499,-	034463	131,-	164,-	034503	95,-	119,-			
T-Rex 50	Alle	034409	399,-	499,-	034463	131,-	164,-	034503	95,-	119,-			
Tornado 50	Alle	034409	399,-	499,-	034463	131,-	164,-	034503	95,-	119,-			
PIAGGIO/VESPA													
ET2 50	97->	034405	399,-	499,-				034501	198,-	248,-			
NRG Extreme MC3 AC 50	Alle	034405	399,-	499,-				034501	198,-	248,-			
NRG Extreme MC3 LC 50	Alle	034405	399,-	499,-									
NRG MC-2 LC 50	94->	034404	399,-	499,-	034457	131,-	164,-	110061	198,-	248,-			
Typhoon 50	Alle	034404	399,-	499,-	034457	131,-	164,-	110061	91,-	248,-			
Typhoon-X 50	02->	034405	399,-	499,-				034501	198,-	248,-			
Zip 2000 50	00->	034404	399,-	499,-				034501	198,-	248,-			
Zip 50	93->	034404	399,-	499,-	034457	131,-	164,-	034501	198,-	248,-			
SANELI													
Bahne 50 (4 t.)	Alle	034413	269,-	336,-				034506	49,-	61,-			
STRANGER													
X-fight 50 (4 t.)	Alle	034413	269,-	336,-				034506	49,-	61,-			
SUZUKI													
Adress AP-50	Alle	034402	399,-	499,-	034456	131,-	164,-	034505	95,-	119,-	034412	199,-	249,-
Estilite, UF-50	Alle	034402	399,-	499,-	034456	131,-	164,-	034505	95,-	119,-	034412	199,-	249,-
Katana AY-50 AC	Alle	034402	399,-	499,-	034456	131,-	164,-	034505	95,-	119,-	034412	199,-	249,-
Katana AY-50 LC	Alle	034402	399,-	499,-	034456	131,-	164,-	034505	95,-	119,-	034412	199,-	249,-
Zillion LC, UX-50	Alle	034402	399,-	499,-	034456	131,-	164,-	034505	95,-	119,-	034412	199,-	249,-
TEXAS													
Chili 50 (4 t.)	Alle	034413	269,-	336,-									
City 50 (4 t.)	Alle	034413	269,-	336,-				034506	49,-	61,-			
Flash 50 (4 t.)	Alle	034413	269,-	336,-				034506	49,-	61,-			
Free 50 (4 t.)	Alle	034413	269,-	336,-				034506	49,-	61,-			
TGB/TOBI													
303/309 50	Alle	034402	399,-	499,-									
Akros 50	Alle	034402	399,-	499,-									
TMP													
Baboon 50	Alle	034401	399,-	499,-	034453	131,-	164,-	034500	93,-	116,-			
Gazelle 50	Alle	034401	399,-	499,-	034453	131,-	164,-	034500	93,-	116,-			
TMS													
Retro 50 (4 t.)	Alle	034413	269,-	336,-				034506	49,-	61,-			
S3 50 (4 t.)	Alle	034413	269,-	336,-				034506	49,-	61,-			
Z2 50 (4 t.)	Alle	034413	269,-	336,-				034506	49,-	61,-			
TOBILINER													
QT 50 (4 t.)	Alle	034413	269,-	336,-				034506	49,-	61,-			
YAMAHA													
Aerox, AN-50	97->	034401	399,-	499,-	034453	131,-	164,-	034500	93,-	116,-			
Aerox-R, AN-50	03->	034401	399,-	499,-	034453	131,-	164,-	034500	93,-	116,-			
ATV 50 cc	Alle	034401	399,-	499,-				034500	93,-	116,-			
Axis 50	95->	034401	399,-	499,-	034450	131,-	164,-	034500	93,-	116,-			
Bump 50	97->	034400	399,-	499,-				034500	93,-	116,-			
BW's 50	Alle	034400	399,-	499,-	034450	131,-	164,-	034500	93,-	116,-			
BW's N.G. 50	Alle	034400	399,-	499,-	034450	131,-	164,-	034500	93,-	116,-			
Jog Artistic - Fine Selection 50	Alle	034401	399,-	499,-	034450	131,-	164,-	034500	93,-	116,-			
Jog Space Innovation 50	98->	034401	399,-	499,-	034450	131,-	164,-	034500	93,-	116,-			
Jog-R 50	03->	034401	399,-	499,-				034500	93,-	116,-			
Jog-RR 50	03->	034401	399,-	499,-				034500	93,-	116,-			
Neo's 50	Alle	034401	399,-	499,-	034450	131,-	164,-	034500	93,-	116,-			
Slider 50	01->	034400	399,-	499,-	034401	399,-	499,-	034500	93,-	116,-			
Spy 50	Alle	034400	399,-	499,-	034450	131,-	164,-	034500	93,-	116,-			
Why 50	99->	034401	399,-	499,-	034450	131,-	164,-	034500	93,-	116,-			
YIYING													
Stranger 50 (4 t.)	Alle	034413	269,-	336,-				034506	49,-	61,-			

Mærke/model	Årg.	Mål	Drivrem standard Varenr.			Drivrem kevlar Varenr.		
Märke/modell	Årg.	Mått	Drivrem standard Art.nr.	DKK	SEK	Drivrem kevlar Art.nr.	DKK	SEK
ADLY								
Cat 50	Alle	757*17*9	038000	173,-	216:-	038100	205,-	256:-
Jet 50	Alle	890*16	038015	173,-	216:-			
Silver Fox 50	Alle	757*17*9	038000	173,-	216:-	038100	205,-	256:-
Super Sonic 50	Alle	890*16	038015	173,-	216:-			
Thunder Bike 50	Alle	890*16	038015	173,-	216:-			
APRILIA								
Amico 50	Alle	757*17*9	038000	173,-	216:-	038100	205,-	256:-
Area 51 LC 50	98->	757*17*9	038000	173,-	216:-	038100	205,-	256:-
Gulliver AC 50	Alle	757*17*9	038000	173,-	216:-	038100	205,-	256:-
Habana AC (Morini) 50	Alle	781*17*9	038013	173,-	216:-	038113	205,-	256:-
Rally AC 50	Alle	757*17*9	038000	173,-	216:-	038100	205,-	256:-
Rally LC 50	Alle	757*17*9	038000	173,-	216:-	038100	205,-	256:-
Scarabeo AC 50	Alle	757*17*9	038000	173,-	216:-	038100	205,-	256:-
Scarabeo Ditech (Morini) 50	02->	785*17.5	038018	173,-	216:-			
Sonic AC 50	98->	805*17*9	038010	173,-	216:-	038110	205,-	256:-
Sonic LC 50	Alle	805*17*9	038010	173,-	216:-	038110	205,-	256:-
SR 50 AC (Lodret)	->93	757*17*9	038000	173,-	216:-	038100	205,-	256:-
SR 50 AC (Vandret)	->96	757*17*9	038000	173,-	216:-	038100	205,-	256:-
SR - (Morini) 50	Alle	781*17*9	038013	173,-	216:-	038113	205,-	256:-
SR - www AC 50	97->	757*17*9	038000	173,-	216:-	038100	205,-	256:-
SR-Racing50 , Stealth, Netscaper LC	Alle	757*17*9	038000	173,-	216:-	038100	205,-	256:-
SR-Replica LC (Minarelli) 50	->00	757*17*9	038000	173,-	216:-	038100	205,-	256:-
SR-Replica-2000 LC (Morini) 50	00->	781*17*9	038013	173,-	216:-	038113	205,-	256:-
ATALA								
Carosello 50	Alle	757*17*9	038000	173,-	216:-	038100	205,-	256:-
Hacker AT-12 50	Alle	808*16.8	038004	173,-	216:-			
Hacker LC 50	Alle	808*16.8	038004	173,-	216:-			
Skeggia 50	Alle	808*16.8	038004	173,-	216:-			
BAOTAIN								
BT-QT-8/11 50 (4 t.) 10"	Alle	845*16	038014	173,-	216:-	038114	205,-	256:-
Rebel 50 (4.T.)	Alle							
Supermoto 50 (4 t.)	Alle							
Rocky 50 (4 t.)	Alle							
BENELLI								
491 GT 50	97->	757*17*9	038000	173,-	216:-	038100	205,-	256:-
491 Sport 50	97->	757*17*9	038000	173,-	216:-	038100	205,-	256:-
K2/LC 50	Alle	757*17*9	038000	173,-	216:-	038100	205,-	256:-
BETA								
Ark AC 50	Alle	757*17*9	038000	173,-	216:-	038100	205,-	256:-
Ark/LC 50	Alle	757*17*9	038000	173,-	216:-	038100	205,-	256:-
CAGIVA								
Progress 50 (Derbi)	Alle	845*16	038014	173,-	216:-	038114	205,-	256:-
CPI								
Aragon (Euro 2)	Alle	805*18*9	038009	173,-	216:-	038109	205,-	256:-
Formula R 50 (Euro 2)	Alle	805*18*9	038009	173,-	216:-	038109	205,-	256:-
Hussar 50	Alle	805*18*9	038009	173,-	216:-	038109	205,-	256:-
Oliver/City 50 (Euro 2)	Alle	805*18*9	038009	173,-	216:-	038109	205,-	256:-
Popcorn 50	Alle	805*18*9	038009	173,-	216:-	038109	205,-	256:-
DAELIM								
S-Five 50	Alle	845*16	038014	173,-	216:-	038114	205,-	256:-
DERBI								
Atlantis 50	Alle	845*16	038014	173,-	216:-	038114	205,-	256:-
Atlantis (Piaggio) 50	03->	820*18	038011	173,-	216:-	038111	251,-	314:-
GP1 (Piaggio) 50	03->	820*18	038011	173,-	216:-	038111	251,-	314:-
Hunter 50	Alle	845*16	038014	173,-	216:-	038114	205,-	256:-
Manhattan 50	Alle	845*16	038014	173,-	216:-	038114	205,-	256:-
MotoGP (GP1) 50	Alle	845*16	038014	173,-	216:-	038114	205,-	256:-
Paddock 50	Alle	845*16	038014	173,-	216:-	038114	205,-	256:-
Predator LC 50	Alle	845*16	038014	173,-	216:-	038114	205,-	256:-
Vamos (Morini) 50	Alle	720*14.5	038001	173,-	216:-	038101	205,-	256:-
FALCON								
Big Wheel 50	Alle	805*17*9	038010	173,-	216:-	038110	205,-	256:-
Star-50	Alle	805*17*9	038010	173,-	216:-	038110	205,-	256:-
FYM								
QT 50	Alle							
GENERIC								
Ideo 50	Alle	805*18*9	038009	173,-	216:-	038109	205,-	256:-
Race 50	09->	805*18*9	038009	173,-	216:-	038109	205,-	256:-
Xor 50	Alle	805*18*9	038009	173,-	216:-	038109	205,-	256:-

Original leverandør til mange mærker.

BEMÆRK! Ved brug af forstærkede koblingstrykfedre anbefales at der bruges Kevlar forstærket drivrem, for at undgå brud.

Original leverantör till många märken.

OBS! Vid användning av förstärkta kopp-lingsfjädrar rekommenderas Kevlar förstärkta drivremmar.



Forhandlere
Återförsäljare
s. 2

Stikord
Sökord
s. 4

Tøj/hjelme
Klæder/
hjelmar
s. 6

Dæk og
slanger
Dæk og
slangar
s. 15

Olje / spray
Olja / spray
s. 26

Kæder /
tandhjul
Kedjor /
drev
s. 43

Bremselede
Bromsdelar
s. 48

Låse
Lås
s. 93

Batteri
Batteri
s. 96

Cylinder /
topstykke
Cylinder /
topplock
s. 105

Motordele
Motordele
s. 137

Karburator
- Luftfilter
Förgasare
- Luftfilter
s. 208

El-dele
tændrør
Elektrisk
tændstift
s. 222

Udstødning
Avgassystem
s. 246

Forgaffel
Støddæmpere
Framgaffel
Støtdåmpare
s. 260

Kabler
Wire
s. 266

Styr og
greb
Styre och
handtag
s. 272

Spejle
Speglar
s. 282

Blinklygter
Baglygter
Blinkers
Baklygte
s. 284

Støtteben
Topboks, mm.
Stödd
Topbbox, mm
s. 291

Rep. bøger
værktøj
Rep. böcker
Verktyg
s. 297



Märke/model	Årg.	Mål	Drivrem standard Varenr.			Drivrem kevlar Varenr.		
Märke/modell	Årg.	Mått	Art.nr.	DKK	SEK	Art.nr.	DKK	SEK
GIANTCO								
Sprint 50	Alle							
Stealth 50	Alle							
Venus 50	Alle							
GILERA								
DNA LC 50	Alle	820*18	038011	173,-	216,-	038111	251,-	314,-
ICE AC 50	Alle	805*18*9	038009	173,-	216,-	038109	205,-	256,-
Runner AC 50	Alle	820*18	038011	173,-	216,-	038111	251,-	256,-
GILERA								
Runner LC 50	Alle	820*18	038011	173,-	216,-	038111	251,-	314,-
Runner PJ 50	03->	805*18*9	038009	173,-	216,-	038109	205,-	256,-
Runner SP LC 50	02->	820*18	038011	173,-	216,-	038111	251,-	314,-
Stalker 50	Alle	820*18	038011	173,-	216,-	038111	251,-	314,-
Typhoon 50	->01	805*18*9	038009	173,-	216,-	038109	205,-	256,-
Typhoon-X 50	02->	820*18	038011	173,-	216,-	038111	251,-	314,-
HONDA								
SFX 50	Alle	700*17,5*9	038003	173,-	216,-	038103	205,-	256,-
Sky 50	Alle	835*17	038012	173,-	216,-			
Vision Met In 50	Alle	660*15	038002	173,-	216,-	038102	205,-	256,-
Vision SA 50	Alle	660*15	038002	173,-	216,-	038102	205,-	256,-
X8-R 50	Alle	835*17	038012	173,-	216,-			
Wallaroo 50	Alle		038016	173,-	216,-			
HYOSUNG								
SB 50 M (Cab)	Alle	641*15,5*30	038002	173,-	216,-			
SF 50 B (Racing)	Alle	707*17,5*30	038008	173,-	216,-			
SF 50 R (Rally)	Alle	808*16.8	038008	173,-	216,-			
ITALJET								
Formula 50	Alle	757*17*9	038000	173,-	216,-	038100	205,-	256,-
Velocifero 50	Alle	757*17*9	038001	173,-	216,-	038101	205,-	256,-
KEEWAY								
F-act 50	Alle	805*18*9	038009	173,-	216,-	038109	205,-	256,-
Flash 50	Alle	805*18*9	038009	173,-	216,-	038109	205,-	256,-
Focus 50	Alle	805*18*9	038009	173,-	216,-	038109	205,-	256,-
Matrix 50	Alle	805*18*9	038009	173,-	216,-	038109	205,-	256,-
KREIDLER								
Easy Rider 50	Alle	805*17*9	038010	173,-	216,-	038110	205,-	256,-
KYMCO								
Agility 50 (4 t.)	05->							
Agility 50 (4 t.) 12"	Alle	707*17,5*30	038008	173,-	216,-			
Bet x Win 50		750*17	038006	173,-	216,-	038106	205,-	256,-
Bet x Win 50 Euro 2		707*17,5*30	038008	173,-	216,-			
Fever ZX 50	Alle	735*17.5	038019	173,-	216,-	038119	205,-	256,-
People 50	99-04	750*17	038006	173,-	216,-	038106	205,-	256,-
People S 50	05->	724*17,5*9	038008	173,-	216,-	038108	205,-	256,-
Super 9 50	Alle	750*17	038006	173,-	216,-	038106	205,-	256,-
MALAGUTI								
F10 AC 50	Alle	805*17*9	038010	173,-	216,-	038110	205,-	256,-
F12 Phantom AC 50	Alle	757*17*9	038000	173,-	216,-	038100	205,-	256,-
F15 Firefox LC 50	Alle	757*17*9	038000	173,-	216,-	038100	205,-	256,-
PEUGEOT								
Buxy 50	94->	766*17.5*9	038005	173,-	216,-	038105	205,-	256,-
Elyseo-50	Alle	766*17.5*9	038005	173,-	216,-	038105	205,-	256,-
Elystar-50 TSDI	03->	766*17.5*9	038005	173,-	216,-	038105	205,-	256,-
Fox 25 50	03->	766*17.5*9	038005	173,-	216,-	038105	205,-	256,-
Jetforce 50	03->	766*17.5*9	038005	173,-	216,-	038105	205,-	256,-
Looxor 50	Alle	835*17	038012	173,-	216,-			
Ludix 50 One	Alle	766*17.5*9	038005	173,-	216,-	038105	205,-	256,-
Speedake 50	95->	766*17.5*9	038005	173,-	216,-	038105	205,-	256,-
Speedfight -2 AC 50	Alle	766*17.5*9	038005	173,-	216,-	038105	205,-	256,-
Speedfight AC 50	95->	766*17.5*9	038005	173,-	216,-	038105	205,-	256,-
Speedfight LC 50	Alle	766*17.5*9	038005	173,-	216,-	038105	205,-	256,-
Squab 50	95->	766*17.5*9	038005	173,-	216,-	038105	205,-	256,-
TKR 50	Alle	766*17.5*9	038005	173,-	216,-	038105	205,-	256,-
Trekker 50	98->	766*17.5*9	038005	173,-	216,-	038105	205,-	256,-
Trekker/Metal X 50	03->	766*17.5*9	038005	173,-	216,-	038105	205,-	256,-
Vivacity 50	Alle	766*17.5*9	038005	173,-	216,-	038105	205,-	256,-
Zenith 50	94->	700*17.5*9	038003	173,-	216,-	038103	205,-	256,-
PEXMA								
KD 50 (4 t.)	Alle							

DKK Drivrem standard:
 Er fremstillet til brug på standard scootere i en kvalitet som originalt.

DKK Drivrem kevlar:
 Er en kevlar-forstærket rem, som tåler et kraftigt træk, velegnet til race.

SEK Drivrem standard:
 Tillverkad i originalkvalitet till standard scooters.

SEK Drivrem kevlar:
 Extra stark drivrem tillverkad av kevlar. Rekommenderas till tävling och tuff körning.

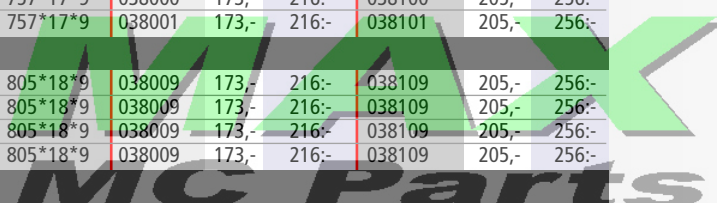



Mærke/model	Årg.	Mål	Drivrem standard Varenr.			Drivrem kevlar Varenr.		
Mærke/modell	Årg.	Mått	Drivrem standard Art.nr.	DKK	SEK	Drivrem kevlar Art.nr.	DKK	SEK
PGO								
Big Max 50	Alle	750*17	038006	173,-	216:-	038106	205,-	256:-
Black Magic 50	Alle	750*17	038006	173,-	216:-	038106	205,-	256:-
Bubu 50	Alle	750*17	038006	173,-	216:-	038106	205,-	256:-
Comet 50	Alle	670*17	038017	173,-	216:-			
Dr. Big 50	Alle	750*17	038006	173,-	216:-	038106	205,-	256:-
Galaxy 50	Alle	750*17	038006	173,-	216:-	038106	205,-	256:-
G-Max 50	Alle	750*17	038006	173,-	216:-	038106	205,-	256:-
Hot-50	Alle	750*17	038006	173,-	216:-	038106	205,-	256:-
Ligero 50	Alle	750*17	038006	173,-	216:-	038106	205,-	256:-
PMS 50	Alle	750*17	038006	173,-	216:-	038106	205,-	256:-
PMX 50	Alle	750*17	038006	173,-	216:-	038106	205,-	256:-
Rodoshow 50	Alle	670*17	038017	173,-	216:-			
Streetfighter 50	Alle	750*17	038006	173,-	216:-	038106	205,-	256:-
T-Rex 50	Alle	750*17	038006	173,-	216:-	038106	205,-	256:-
Tornado 50	Alle	750*17	038006	173,-	216:-	038106	205,-	256:-
PIAGGIO/VESPA								
ET2 50	->99	724*17,5*9	038008	173,-	216:-	038108	205,-	256:-
ET2 50	00->	735*17,5	038019	173,-	216:-	038119	205,-	256:-
NRG Extreme MC3 AC 50	Alle	820*18	038011	173,-	216:-	038111	251,-	314:-
NRG Extreme MC3 LC 50	Alle	820*18	038011	173,-	216:-	038111	251,-	314:-
NRG MC-2 LC 50	94->	805*18*9	038009	173,-	216:-	038109	205,-	256:-
Typhoon 50	Alle	805*18*9	038009	173,-	216:-	038109	205,-	256:-
Vespa ET4 50	00->	735*17,5	038019	173,-	216:-	038119	205,-	256:-
Zip 2000 50	00->	735*17,5	038019	173,-	216:-	038119	205,-	256:-
Zip 50	93->	724*17,5*9	038008	173,-	216:-	038108	205,-	256:-
RIEJU								
Crosser 50	Alle	757*17*9	038000	173,-	216:-	038100	205,-	256:-
First 50	Alle	757*17*9	038000	173,-	216:-	038100	205,-	256:-
Windy 50	Alle	757*17*9	038000	173,-	216:-	038100	205,-	256:-
STRANGER								
X-fight 50 (4 t.)	Alle							
SUZUKI								
Adress AP-50	Alle	675*17*9	038007	173,-	216:-	038107	205,-	256:-
Estilette 50	98->	785*17,5	038018	173,-	216:-			
Katana AY AC 50	97-99	781*17*9	038013	173,-	216:-	038113	205,-	256:-
Katana AY LC 50	97-99	781*17*9	038013	173,-	216:-	038113	205,-	256:-
Katana AY W-V 50	00->	785*17,5	038018	173,-	216:-			
Street Magic 50	Alle	785*17,5	038018	173,-	216:-			
Zillion LC 50	Alle	785*17,5	038018	173,-	216:-			
SYM								
Fiddle DD 50	Alle	670*17	038017	173,-	216:-			
Jet/Euro X EU Sport-X	96->	724*17,5*9	038008	173,-	216:-	038108	205,-	256:-
Jungle 50	99->	724*17,5*9	038008	173,-	216:-	038108	205,-	256:-
Jet 50	Alle	750*17	038006	173,-	216:-	038106	205,-	256:-
Mask 50 /Euro 2	00->	724*17,5*9	038008	173,-	216:-	038108	205,-	256:-
Super Fancy 50	Alle	750*17	038006	173,-	216:-	038106	205,-	256:-
TOBILINER								
QT 50 (4 t.)	Alle							
TEXAS								
Chili 50 (4 t.)								
TGB/TOBI								
303/309 50	Alle	675*17*9	038007	173,-	216:-	038107	205,-	256:-
Akros 50	Alle	675*17*9	038007	173,-	216:-	038107	205,-	256:-
TMP								
Baboon 50	Alle	805*17*9	038010	173,-	216:-	038110	205,-	256:-
Gazelle 50	Alle	805*17*9	038010	173,-	216:-	038110	205,-	256:-
YAMAHA								
Aerox 50	97->	757*17*9	038000	173,-	216:-	038100	205,-	256:-
ATV 50 cc	Alle	805*17*9	038010	173,-	216:-	038110	205,-	256:-
Axis 50	95->	805*17*9	038010	173,-	216:-	038110	205,-	256:-
Bump 50	97->	757*17*9	038000	173,-	216:-	038100	205,-	256:-
BW's 50	Alle	757*17*9	038000	173,-	216:-	038100	205,-	256:-
BW's N.G. 50	Alle	757*17*9	038000	173,-	216:-	038100	205,-	256:-
Jog Artistic - Fine Selection 50	Alle	805*17*9	038010	173,-	216:-	038110	205,-	256:-
Jog Space Innovation 50	Alle	805*17*9	038010	173,-	216:-	038110	205,-	256:-
Jog-R AC 50	03->	757*17*9	038000	173,-	216:-	038100	205,-	256:-
Jog-RR LC 50	03->	757*17*9	038000	173,-	216:-	038100	205,-	256:-
Neo's 50	97->	757*17*9	038000	173,-	216:-	038100	205,-	256:-
Slider 50	01->	757*17*9	038000	173,-	216:-	038100	205,-	256:-
Spy 50	Alle	757*17*9	038000	173,-	216:-	038100	205,-	256:-
Why 50	99->	757*17*9	038000	173,-	216:-	038100	205,-	256:-

Original leverandør til mange mærker.
BEMÆRK! Ved brug af forstærkede koblingstrykfjedre anbefales at der bruges Kevlar forstærket drivrem, for at undgå brud.

Original leverantör till många märken.
OBS! Vid användning av förstärkta kopp-lingsfjädrar rekommenderas Kevlar förstärkta drivremmar.

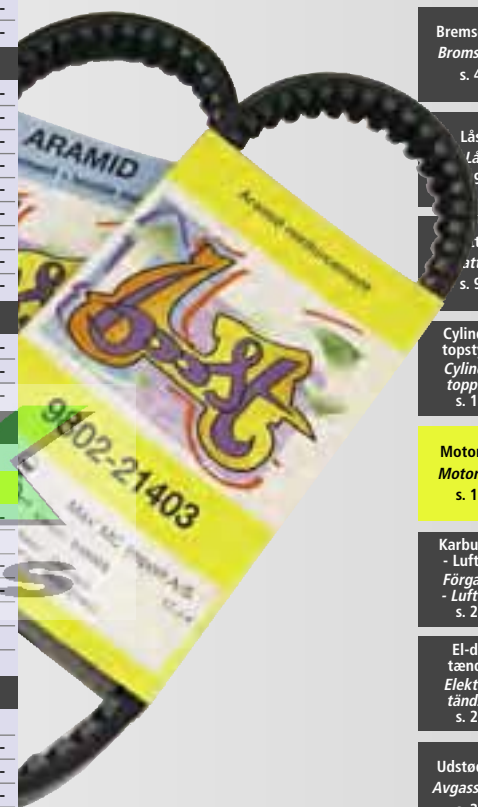

Forhandlere
Återförsäljare
s. 2

Stikord
Sökord
s. 4

Tøj/hjelme
Klæder/
hjelmar
s. 6

Dæk og
slanger
Dæk
och
slangar
s. 15

Olie / spray
Olja / spray
s. 26

Kæder /
tandhjul
Kedjor /
drev
s. 43

Bremse dele
Bromsdelar
s. 48

Låse
Lås
93

Batteri
Batteri
s. 96

Cylinder /
topstykke
Cylinder /
topplöck
s. 105

Motor dele
Motor delar
s. 137

Karburator
- Luftfilter
Förgasare
- Luftfilter
s. 208

El-dele
tændrør
Elektrisk
tændstift
s. 222

Udstødning
Avgassystem
s. 246

Forgaffel
Støddæmpere
Framgaffel
Støtdämpare
s. 260

Kabler
Wire
s. 266

Styr og
greb
Styre och
handtag
s. 272

Spejle
Speglar
s. 282

Blinklygter
Baglygter
Blinkers
Baklygte
s. 284

Støtteben
Topboks, mm.
Stödd
Topbbox, mm
s. 291

Rep. bøger
værktøj
Rep. böcker
Verktyg
s. 297



Märke/model	Årg.	Drivrem Varenr.	OEM LxBxVxH Mål	DKK	SEK
Märke/modell	Årg.	Drivrem Art.nr.	OEM LxBxVxH Mått	DKK	SEK
ADLY					
50 Air Tec 1	06	038320	782x16,8x28x8	170,-	213,-
50 Cat		038320	782x16,8x28x8	170,-	213,-
50 Jet		038320	782x16,8x28x8	170,-	213,-
50 Noble	06>	038320	782x16,8x28x8	170,-	213,-
50 SF Silver Fox 2T		038320	782x16,8x28x8	170,-	213,-
50 Noble 4T		038327	729x18x30x8,5	228,-	285,-
50 Panther	06>	038320	782x16,8x28x8	170,-	213,-
50 SF Silver Fox 2T		038320	782x16,8x28x8	170,-	213,-
50 SF Silver Fox 4T		038321	669x18x30x8	170,-	213,-
50 Supersonic 2T		038320	782x16,8x28x8	170,-	213,-
50 Supersonic 4T		038327	729x18x30x8,5	228,-	285,-
50 TB Thunder Bike 2T	04>	038320	782x16,8x28x8	170,-	213,-
50 TB Thunder Bike 4T		038327	729x18x30x8,5	228,-	285,-
AEON					
50 Aero 2T	99-09	038320	782x16,8x28x8	170,-	213,-
50 Echo 2T	99-09	038320	782x16,8x28x8	170,-	213,-
50 Regal 2T	99-09	038320	782x16,8x28x8	170,-	213,-
50 Torch	99-01	038320	782x16,8x28x8	170,-	213,-
APRILIA					
50 Amico LK/LX/GL/Sport	92-99	038317	738x16,5x28x8	145,-	181,-
50 Area 51	98-00	038317	738x16,5x28x8	145,-	181,-
50 Gulliver Air/LC	94-00	038317	738x16,5x28x8	145,-	181,-
50 Habana/Custom	99-02	038302	785x18,4x30x8	175,-	219,-
50 Mojito Retro/Custom 2T (Motor Aprilia)	99-03	038302	785x18,4x30x8	175,-	219,-
50 Mojito Custom 2T (Motor Piaggio)	04-08	038300	805x18,7x30x8	185,-	231,-
50 Rally Air/LC	94-04	038317	738x16,5x28x8	145,-	181,-
50 Scarabeo Street 2T (Motor Minarelli)	93-06	038317	738x16,5x28x8	145,-	181,-
50 Scarabeo /Street/Rst 2T (Motor Piaggio)	05-10	038301	830x18,5x30x8	178,-	223,-
50 Scarabeo Di-tech	01-07	038302	785x18,4x30x8	175,-	219,-
50 Scarabeo 4T	03-06	038301	830x18,5x30x8	178,-	223,-
50 Scarabeo Rst Euro 3 4T	06-10	038301	830x18,5x30x8	178,-	223,-
50 Scarabeo Quattro 4V 4T	09-10	038301	830x18,5x30x8	178,-	223,-
50 Sonic AC/LC	98-08	038320	782x16,8x28x8	170,-	213,-
50 Sport City One 4T	08-10	038301	830x18,5x30x8	178,-	223,-
50 Sport City One/Street 2T	08-10	038301	830x18,5x30x8	178,-	223,-
50 SR AC Urban/Viper/Replica/Europe (Motor Minarelli lodret)	93-06	038317	738x16,5x28x8	145,-	181,-
50 SR AC Esquire/Urban/Wave/Sunfire (Motor Minarelli vandret)	94-96	038317	738x16,5x28x8	145,-	181,-
50 SR (LC) Replica	94-96	038317	738x16,5x28x8	145,-	181,-
50 SR WWW	97-02	038317	738x16,5x28x8	145,-	181,-



Bando drivremme

Bando Chemical Industries, med 17 fabrikker i 15 lande, har hovedkontor i Kobe i Japan. Bando er mere end 100 år gammelt. De er banebrydende i teknologier og udvikling af alle typer af transmissionsprodukter.

Bando er globalt førende inden for produktion af drivremme til både industri- og bilindustrien som OEM leverandør. Bando har også et internationalt netværk af industri- og automotive eftermarked distributører.

Kvalitet, service og værdi er grundlaget for Bandos filosofi. Med et stort fokus på udvikling af produkter, der er sikre og miljøvenlige for samfundet.

Bando drivremmar

Bando Chemical Industries, med 17 fabrikker i 15 länder, har huvudkontor i Kobe i Japan. Bando är mer än 100 år gammalt. De banbrytande inom teknologi och utveckling av alla typer av transmissionsprodukter.

Bando är ledande inom produktion av drivremmar till både industri- och bilindustri som global OEM leverantör. Bando har också ett internationellt nätverk av distributörer inom eftermarknaden för industri- och bilindustri.

Kvalitet, service och värde är grunden för Bandos filosofi. Med ett stort fokus på utveckling av produkter som är säkra och miljövänliga.



Mærke/model	Årg.	Drivrem OEM Varenr.	LxBxVxH Mål	DKK	SEK
Mærke/modell	Årg.	Drivrem OEM Art.nr.	LxBxVxH Mått	DKK	SEK
APRILIA					
50 SR Netscaper	97-00	038317	738x16,5x28x8	145,-	181,-
50 SR Racing/Stealth (Motor Minarelli)	97-00	038317	738x16,5x28x8	145,-	181,-
50 SR Racing/Sport (Motor Aprilia)	00-04	038302	785x18,4x30x8	175,-	219,-
50 SR Di-tech	00-04	038302	785x18,4x30x8	175,-	219,-
50 SR D-Tech Euro2	02-04	038302	785x18,4x30x8	175,-	219,-
50 SR New Di-Tech	04-06	038302	785x18,4x30x8	175,-	219,-
50 SR R Factory (Motor Di-Tech)	04-06	038302	785x18,4x30x8	175,-	219,-
50 SR R Factory (Motor Piaggio)	04-10	038341	808x16,5x	145,-	181,-
50 SR R (Piaggio carb).	04-10	038300	805x18,7x30x8	185,-	231,-
50 SR Street (Piaggio carb).	03-10	038300	805x18,7x30x8	185,-	231,-
50 SR Street IE (Motor Piaggio)	03-10	038341	808x16,5x	145,-	181,-
ATALA					
50 Byte AT10 (Motor F. Morini)		038316	799x17x28x9,5	275,-	344,-
50 Carosello (Motor minarelli)		038317	738x16,5x28x8	145,-	181,-
50 Hacker/LC AT12/AT14	96/99	038316	799x17x28x9,5	275,-	344,-
50 Skeggia/LC (Motor F. Morini)		038317	738x16,5x28x8	145,-	181,-
AVANTI					
9 N 50 (4 t.)	10"	Alle	038321	669x18x30x8	170,- 213,-
Sport Classic 50 (4 t.)	12"	Alle	038327	729x18x30x8,5	228,- 285,-
Eagle 50 (4 t.)	12"	Alle	038327	729x18x30x8,5	228,- 285,-
Avanti Wolf 50 (4 t.)	12"	Alle	038327	729x18x30x8,5	228,- 285,-
BAOTAIN					
50 BT49QT-7 R 4T	12"		038327	729x18x30x8,5	228,- 285,-
50 BT49QT-8 4T	10"	05-08	038321	669x18x30x8	170,- 213,-
50 BT49QT-9 4T	10"		038321	669x18x30x8	170,- 213,-
50 BT49QT-9 4T	12"		038327	729x18x30x8,5	228,- 285,-
50 BT49QT-10 4T	10"		038321	669x18x30x8	170,- 213,-
50 BT49QT-11 4T	10"		038321	669x18x30x8	170,- 213,-
50 BT49QT-12 4T	10"		038321	669x18x30x8	170,- 213,-
50 BT49QT-12 4T	12"		038327	729x18x30x8,5	228,- 285,-
BENDA					
Scoot 50 (4 t.)	12"		038327	729x18x30x8,5	228,- 285,-
BENELLI					
50 Naked (Motor Minarelli)	02	038317	738x16,5x28x8	145,-	181,-
50 Naked (Motor Morini)	03>	038316	799x17x28x9,5	275,-	344,-
50 491 GT/SP	97-02	038317	738x16,5x28x8	145,-	181,-
50 491 Sport/Racing	98-02	038317	738x16,5x28x8	145,-	181,-
50 491 RR/ST (Motor Minarelli)	97-02	038317	738x16,5x28x8	145,-	181,-
50 491 RR/ST (Motor Morini)	03>	038316	799x17x28x9,5	275,-	344,-
50 K2 Air/LC (Motor Minarelli)	98>	038317	738x16,5x28x8	145,-	181,-
BETA					
50 Tempo	13"	94-95	038317	738x16,5x28x8	145,- 181,-
50 Tempo	16"	96>	038317	738x16,5x28x8	145,- 181,-
50 Quadro/Chrono 502	95>	038317	738x16,5x28x8	145,-	181,-
50 Ark AC/LC	96-11	038317	738x16,5x28x8	145,-	181,-
50 Eikon	99>	038317	738x16,5x28x8	145,-	181,-
CAGIVA					
50 City		038310	722x16,5x28x	175,-	219,-
50 Progress AC		038339	828x16,3x	178,-	223,-
50 Progress LC		038340	840x16,8x	178,-	223,-
CPI					
50 Aragon	Alle	038320	782x16,8x28x8	170,-	213,-
50 Formular R	Alle	038320	782x16,8x28x8	170,-	213,-
50 Hussar/SL/FL/Euro 2	01>	038320	782x16,8x28x8	170,-	213,-
50 Oliver/City/Sport	03>	038320	782x16,8x28x8	170,-	213,-
50 Popcorn/SL/FL/Euro 2	01>	038320	782x16,8x28x8	170,-	213,-
DAELIM					
50 Message	98-00	038315	654x18x30x8,5	178,-	223,-
50 SE-1 E-Five/Euro2	02-03	038303	779x16,9x30x8	175,-	219,-
50 SJ S-Five/Euro2	01-03	038303	779x16,9x30x8	175,-	219,-
DERBI					
50 Atlantis/LC (Motor Derbi)	99-01	038340	840x16,8x	178,-	223,-
50 Atlantis O2/Bullet/Red Bullet (Motor Piaggio)	02-05	038300	805x18,7x30x8	185,-	231,-
50 Atlantis O2 City/Two Chic (Motor Piaggio)	03-06	038300	805x18,7x30x8	185,-	231,-
50 Atlantis 2T Euro 2 (Motor Piaggio)	07-10	038300	805x18,7x30x8	185,-	231,-

Mål på drivrem
Mål av drivremmar

L: Længde/längd
B: Bredde/bredd
H: Højde/höjd
V°: Vinkel

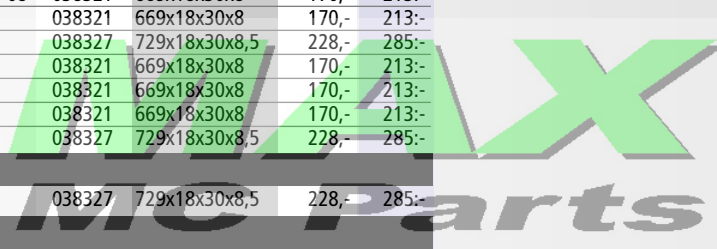
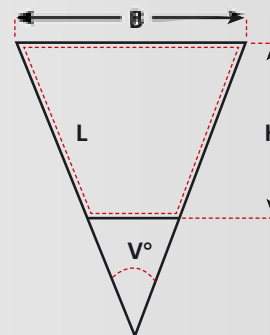

Forhandlere
Återförsäljare
s. 2

Stikord
Sökord
s. 4

Tøj/hjelme
Kläder/
hjälm
s. 6

Dæk og
slanger
Däck och
slangor
s. 15

Olje / spray
olja / spray
s. 26

Kæder /
tandhjul
Kedjor /
drev
s. 43

Bremsedele
Bromsdelar
s. 48

Låse
Lås
s. 93

Batteri
Batteri
s. 96

Cylinder /
topstykke
Cylinder /
topplöck
s. 105

Motordele
Motordele
s. 137

Karburator
- Luftfilter
Förgasare
- Luftfilter
s. 208

El-dele
tændrør
Elektriskt
tändstift
s. 222

Udstødning
Avgassystem
s. 246

Forgaffel
Støddæmpere
Framgaffel
Støtdämpare
s. 260

Kabler
Wire
s. 266

Styr og
greb
Styre och
handtag
s. 272

Spejle
Speglar
s. 282

Blinklygter
Baglygter
Blinkers
Baklykte
s. 284

Støtteben
Topboks, mm.
Stödd
Topbbox, mm
s. 291

Rep. bøger
værktøj
Rep. böcker
Verktyg
s. 297



Mærke/model	Årg.	Drivrem OEM Varenr.	OEM LxBxVxH Mål		
Mærke/modell	Årg.	Drivrem OEM Art.nr.	OEM LxBxVxH Mått	DKK	SEK
DERBI					
50 Atlantis/02/Bullet/City/Two Chic/ Red Bullet/2T Euro 2	02-10	038307	763x18,5x	140,-	175,-
50 Atlantis Euro 2 4T	04-10	038300	830x18,5x30x8	185,-	231,-
50 Boulevard 2T	09-10				
50 Boulevard 4T	09-10	038307	763x18,5x	140,-	175,-
50 GPI (Motor Piaggio)	01-03	038300	805x18,7x30x8	185,-	231,-
50 GPI Euro 2 (Motor Piaggio)	05->	038300	805x18,7x30x8	185,-	231,-
50 GPI/Euro 2/Race/Open	01-10				
50 Hunter 2T	96-97	038339	828x16,3x	178,-	223,-
50 Hunter 2T	99	038340	840x16,8x	178,-	223,-
50 Manhattan 2T	97	038339	828x16,3x	178,-	223,-
50 Paddock 2T	98-99	038339	828x16,3x	178,-	223,-
50 Predator 02/LC 2T	98-01	038339	828x16,3x	178,-	223,-
50 Vamos 2T	93-95	038338	664x16,5x	178,-	223,-
FYM					
QT 50 (4 t.)	10"	Alle	038321	669x18x30x8	170,- 213,-
GENERIC					
50 Ideo 2T	05->	038320	782x16,8x28x8	170,-	213,-
50 Race 2T	10->	038320	782x16,8x28x8	170,-	213,-
50 ROC 2T	08->	038320	782x16,8x28x8	170,-	213,-
50 XOR 2T	05->	038320	782x16,8x28x8	170,-	213,-
GILERA					
50 DNA	00-07	038301	830x18,5x30x8	178,-	223,-
50 Easy Moving	95-96	038304	724x17,5x30x8	158,-	198,-
50 Ice	01->	038300	805x18,7x30x8	185,-	231,-
50 Runner	97-10	038300	805x18,7x30x8	185,-	231,-
50 Runner PureJet	02-04	038300	805x18,7x30x8	185,-	231,-
50 Runner PureJet	05-09	038341	808x16,5x	145,-	181,-
50 Stalker	97-11	038300	805x18,7x30x8	185,-	231,-
50 Storm	93-96	038305	804x17,5x30x8	178,-	223,-
50 Storm Euro 2	07-09	038300	805x18,7x30x8	185,-	231,-
50 Typhoon X	93-99	038305	804x17,5x30x8	178,-	223,-
50 Typhoon/XR	00-09	038300	805x18,7x30x8	185,-	231,-
HONDA					
50 GP Dio	91->	038315	654x18x30x8,5	178,-	223,-
50 NE Vision L/R	90-94	038313	634x15,5x30x8	165,-	206,-
50 NPS Zoomer 4T	04-10	038334	787x18x30x8	178,-	223,-
50 PK L Wallaroo	90->	038314	1.163x15,5x30x8,5	268,-	335,-
50 SA Vision	88-95	038313	634x15,5x30x8	165,-	206,-
50 SFX/S	95-01	038319	691x18x30x8	158,-	198,-
50 SGX Sky/De Luxe	97->	038323	820x18x30x8	198,-	248,-
50 SJ Bali	93->	038319	691x18x30x8	158,-	198,-
50 SRX Shadow	98->	038319	691x18x30x8	158,-	198,-
50 SZX X8R-S/X	98-01	038323	820x18x30x8	198,-	248,-
HOOPER					
One 50 (4 t.)	12"	Alle	038327	729x18x30x8,5	228,- 285,-
HYOSUNG					
50 Super Cab	Alle	038309	668x16,5x28x	140,-	175,-
50 SF Rally	Alle	038310	722x16,5x28x	175,-	219,-
50 SF B Racing	01->	038310	722x16,5x28x	175,-	219,-
GIANTCO					
Lambos 50	Alle	038320	782x16,8x28x8	170,-	213,-
G-Buddy 50 (4 t.)	10"	Alle	038321	669x18x30x8	170,- 213,-
Sprint 50 (4 t.)	12"	Alle	038327	729x18x30x8,5	228,- 285,-
Stealth 50 (4 t.)	12"	Alle	038327	729x18x30x8,5	228,- 285,-
Venus 50 (4 t.)	10"	Alle	038321	669x18x30x8	170,- 213,-
ITALJET					
50 Jet Set	02-03	038300	805x18,7x30x8	185,-	231,-
50 Torpedo 2T(Motor Morini)	97-00	038316	799x17x28x9,5	275,-	344,-
50 Torpedo 2T(Motor Piaggio)	01-03	038301	830x18,5x30x8	178,-	223,-
50 Torpedo 4T	02-03	038301	830x18,5x30x8	178,-	223,-
50 Formula Air/LC	94-00	038316	799x17x28x9,5	275,-	344,-
50 Dragster	98-00	038317	738x16,5x28x8	145,-	181,-
50 Velocifero	93->	038338	664x16,5x	178,-	223,-
KEEWAY					
50 Matrix	06-11	038320	782x16,8x28x8	170,-	213,-
50 F-act 2T	07->	038320	782x16,8x28x8	170,-	213,-
50 Flash 2T	07->	038320	782x16,8x28x8	170,-	213,-
50 Focus	06->	038320	782x16,8x28x8	170,-	213,-
50 Hurricane	06->	038320	782x16,8x28x8	170,-	213,-
KREIDLER					
50 RMC-E Florett		038320	782x16,8x28x8	170,-	213,-
50 RMC-E Hiker/sport DD		038320	782x16,8x28x8	170,-	213,-



DKK Bando drivremme

Bando Chemical Industries, med 17 fabrikker i 15 lande, har hovedkontor i Kobe i Japan. Bando er mere end 100 år gammelt. De er banebrydende i teknologier og udvikling af alle typer af transmissionsprodukter.

Bando er globalt førende inden for produktion af drivremme til både industri- og bilindustrien som OEM leverandør. Bando har også et internationalt netværk af industri- og automotive eftermarked distributører.

Kvalitet, service og værdi er grundlaget for Bandos filosofi. Med et stort fokus på udvikling af produkter, der er sikre og miljøvenlige for samfundet.

SEK Bando drivremmar

Bando Chemical Industries, med 17 fabrikker i 15 lander, har hovedkontor i Kobe i Japan. Bando är mer än 100 år gammalt. De banbrytande inom teknologi och utveckling av alla typer av transmissionsprodukter.

Bando är ledande inom produktion av drivremmar till både industri- och bilindustri som global OEM leverantör. Bando har också ett internationellt nätverk av distributörer inom eftermarknaden för industri- och bilindustri.

Kvalitet, service och värde är grunden för Bandos filosofi. Med ett stort fokus på utveckling av produkter som är säkra och miljövänliga.



Mærke/model	Årg.	Drivrem OEM Varenr.	LxBxVxH Mål	DKK	SEK
KREIDLER					
50 RMC-H galactica DD		038320	782x16,8x28x8	170,-	213,-
KYMCO					
50 Agility 4T	12"	05>	038327	729x18x30x8,5	228,- 285,-
50 Agility 4T	10"	06>	038321	669x18x30x8	170,- 213,-
50 Bet & Win/Euro 2		02>	038327	729x18x30x8,5	228,- 285,-
50 CX		93>			
/Super (Curio 94-97)			038315	654x18x30x8,5	178,- 223,-
50 Dink 2T/LC/Classic/Euro 2		99-07	038327	729x18x30x8,5	228,- 285,-
50 Dink Rst 4T		07-10	038327	729x18x30x8,5	228,- 285,-
50 DJ X/Y/W		91-00	038315	654x18x30x8,5	178,- 223,-
50 Fever ZX/Euro 2		99/07	038326	721x18x30x8,5	245,- 306,-
50 Filly 4T		98-00	038321	669x18x30x8	170,- 213,-
50 Filly LX 4T		01>	038308	678x17,8x	140,- 175,-
50 heroism		95-97	038321	669x18x30x8	170,- 213,-
50 K12 (Scout)		95-00	038326	721x18x30x8,5	245,- 306,-
50 People 2T/Euro 2		99-10	038327	729x18x30x8,5	228,- 285,-
50 People 5 4T		06-10	038327	729x18x30x8,5	228,- 285,-
50 Super 8 4T		07-10	038327	729x18x30x8,5	228,- 285,-
50 Super 8 2T		09-10	038327	729x18x30x8,5	228,- 285,-
50 Super 9/Sport/Euro 2 2T		00-07	038327	729x18x30x8,5	228,- 285,-
50 Sniper DT 93>/DD		94>	038321	669x18x30x8	170,- 213,-
50 TopBoy On/Off (Cobra)		97-04	038327	729x18x30x8,5	228,- 285,-
50 Vitality 2T/4T		04>	038327	729x18x30x8,5	228,- 285,-

MALAGUTI					
50 F10/Kat./Rst/Euro 2		92-07	038320	782x16,8x28x8	170,- 213,-
50 F10 AC/AC ECO		08-09	038320	782x16,8x28x8	170,- 213,-
50 F12 Phantom/LC/Rst/Euro 2		94-06	038317	738x16,5x28x8	145,- 181,-
50 F12R Phantom AC		07-09	038320	782x16,8x28x8	170,- 213,-
50 F12R Phantom LC		07-09	038317	738x16,5x28x8	145,- 181,-
50 F15 Firefox/LC/Rst/Euro 2		96-08	038317	738x16,5x28x8	145,- 181,-

PEUGEOT					
50 Buxi/RS		94>	038322	755x18x30x8	185,- 231,-
50 Elyseo		97>	038322	755x18x30x8	185,- 231,-
50 Elystar TSDI		03>	038322	755x18x30x8	185,- 231,-
50 Fox/L		94-98	038314	1.163x15,5x30x8,5	268,- 335,-
50 Jet Force		03>	038322	755x18x30x8	185,- 231,-
50 Jet C-Tech		08-09	038322	755x18x30x8	185,- 231,-
50 Loxoor/TDSI		01>	038328	815x18x28x8	185,- 231,-
50 Ludix 2 One/Trend/Snake		04-10	038322	755x18x30x8	185,- 231,-
50 Ludix SP Blaster/RS		05-09	038322	755x18x30x8	185,- 231,-
50 Ludix Classic/Elegance		04-09	038322	755x18x30x8	185,- 231,-
50 Ludix 2 Elegance		09-10	038322	755x18x30x8	185,- 231,-
50 Metal X		02>	038322	755x18x30x8	185,- 231,-
50 New vivacity 2T		07-09	038322	755x18x30x8	185,- 231,-
50 Speedake		95-97	038322	755x18x30x8	185,- 231,-
50 Speedfight AC/LC		97-00	038322	755x18x30x8	185,- 231,-
50 Speedfight 2 AC		05-08	038322	755x18x30x8	185,- 231,-
50 Speedfight 2 LC/WRC		05-08	038322	755x18x30x8	185,- 231,-
50 Speedfight 3/RS		08-11	038322	755x18x30x8	185,- 231,-
50 Squab		95-97	038322	755x18x30x8	185,- 231,-
50 SV Geo		91>	038319	691x18x30x8	158,- 198,-
50 Trekker On Road/Off road		98>	038322	755x18x30x8	185,- 231,-
50 TRK 2 WRC		05-09	038322	755x18x30x8	185,- 231,-
50 Vivacity(Cat./SX/SXR)		99-06	038322	755x18x30x8	185,- 231,-
50 Vivacity 2T		07-09	038322	755x18x30x8	185,- 231,-
50 V-Clic 4T		07-09	038321	669x18x30x8	170,- 213,-
50 X-Fight		00>	038322	755x18x30x8	185,- 231,-
50 X-Race		03>	038322	755x18x30x8	185,- 231,-
50 Zenith		94>	038319	691x18x30x8	158,- 198,-

PEXMA					
KDQT 50 (4 t.)	10"	Alle	038321	669x18x30x8	170,- 213,-

PGO					
50 Big Max 2T		94-11	038336	738x18x30x8,5	175,- 219,-
50 Black Magic 50		Alle	038336	738x18x30x8,5	175,- 219,-
50 Bubu		Alle	038336	738x18x30x8,5	175,- 219,-
50 Comet 2T		92-03	038310	722x16,5x28x	175,- 219,-
50 Dr. Big 2T		Alle	038336	738x18x30x8,5	175,- 219,-
50 G-Max 2T		99-10	038336	738x18x30x8,5	175,- 219,-
50 Galaxy 2T		Alle	038310	722x16,5x28x	175,- 219,-
50 Hot 2T		95-11	038336	738x18x30x8,5	175,- 219,-
50 Liger		Alle	038336	738x18x30x8,5	175,- 219,-
50 PMS		Alle	038336	738x18x30x8,5	175,- 219,-
50 PMX/Sport 2T		99-09	038336	738x18x30x8,5	175,- 219,-
50 PMX Naked 2T		08-11	038336	738x18x30x8,5	175,- 219,-



Mål på drivrem
 Mål av drivremmar

L: Længde/längd
 B: Bredde/bredd
 H: Højde/höjd
 V°: Vinkel

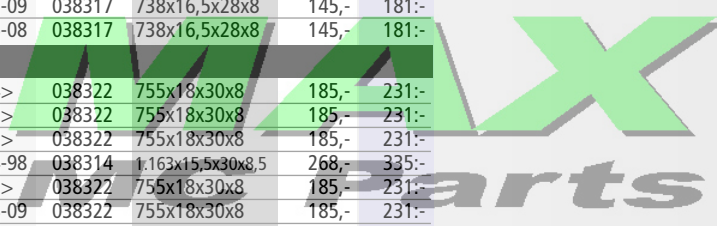
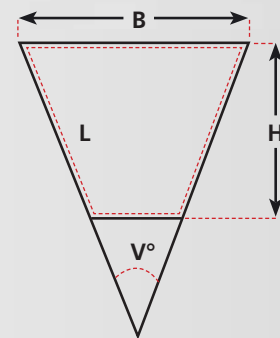

Forhandlere
 Återförsäljare s. 2

Stikord
 Sökord s. 4

Tøj/hjelme
 Kläder/hjälmar s. 6

Dæk og slanger
 Däck och slangar s. 15

Olie / spray
 Olja / spray s. 26

Kæder / tandhjul
 Kedjor / drev s. 43

Bremsedelev
 Bromsdelar s. 48

Låse
 Lås s. 93

Batteri
 Batteri s. 96

Cylinder / topstykke
 Cylinder / topplock s. 105

Motordele
Motordelev s. 137

Karburator
 Luftfilter
 Förgasare
 Luftfilter s. 208

El-dele
 tændrør
 Elektriskt
 tändstift s. 222

Udstødning
 Avgassystem s. 246

Forgaffel
 Støddæmpere
 Framgaffel
 Stötdämpare s. 260

Kabler
 Wire s. 266

Styr og greb
 Styre och handtag s. 272

Spejle
 Speglar s. 282

Blinklygter
 Baglygter
 Blinkers
 Baklygte s. 284

Støtteben
 Topboks, mm.
 Stödd
 Topbbox, mm s. 291

Rep. bøger
 værktøj
 Rep. böcker
 Verktyg s. 297



Märke/model	Årg.	Drivrem OEM Varenr.	OEM LxBxVxH Mål		
Märke/modell	Årg.	Drivrem OEM Art.nr.	OEM LxBxVxH Mått	DKK	SEK
PGO					
50 Rodo Show	Alle	038310	722x16,5x28x	175,-	219,-
50 Streetfighter	Alle	038336	738x18x30x8,5	175,-	219,-
50 Tornado 2T	08-10	038336	738x18x30x8,5	175,-	219,-
50 T-Rex 2T	99-11	038336	738x18x30x8,5	175,-	219,-
PIAGGIO					
50 Fly 2T	05-09	038301	830x18,5x30x8	178,-	223,-
50 Fly 4T	05-10	038307	763x18,5x	140,-	175,-
50 Free	92-01	038305	804x17,5x30x8	178,-	223,-
50 Free FL	95-01	038305	804x17,5x30x8	178,-	223,-
50 Free FL	02->	038300	805x18,7x30x8	185,-	231,-
50 Free Delivery F1	00->	038300	805x18,7x30x8	185,-	231,-
50 Liberty 2T	97->	038301	830x18,5x30x8	178,-	223,-
50 Liberty 4T	00-10	038301	830x18,5x30x8	178,-	223,-
50 NRG	94-96	038305	804x17,5x30x8	178,-	223,-
50 NRG Rst MC2	96-98	038305	804x17,5x30x8	178,-	223,-
50 NRG Extreme	99-00	038300	805x18,7x30x8	185,-	231,-
50 NRG MC3	01-04	038300	805x18,7x30x8	185,-	231,-
50 NRG PureJet	02-04	038300	805x18,7x30x8	185,-	231,-
50 NRG Power Purejet	05-10	038341	808x16,5x	145,-	181,-
50 NRG Power DD	05-10	038300	805x18,7x30x8	185,-	231,-
50 NRG Power DT	06-10	038300	805x18,7x30x8	185,-	231,-
50 NTT	95-96	038305	804x17,5x30x8	178,-	223,-
50 Quartz	92-96	038304	724x17,5x30x8	158,-	198,-
50 Typhoon	01-09	038300	805x18,7x30x8	185,-	231,-
50 Vespa ET2	97-04	038304	724x17,5x30x8	158,-	198,-
50 Vespa ET2	98-05	038306	732x18,5x30x8	140,-	175,-
50 Vespa ET2 Iniezione	97-00	038306	732x18,5x30x8	140,-	175,-
50 Vespa ET2 Iniezione	98-05				
50 Vespa ET4	00-05	038306	732x18,5x30x8	140,-	175,-
50 Zip Base	92-94	038337	734x17,0x	145,-	181,-
50 Zip Base	95-96	038304	724x17,5x30x8	158,-	198,-
50 Zip Rst	96-99	038304	724x17,5x30x8	158,-	198,-
50 Zip Fast Rider/Rst	93-99	038304	724x17,5x30x8	158,-	198,-
50 Zip SP	96-00	038304	724x17,5x30x8	158,-	198,-
50 Zip 4T	08->	038306	732x18,5x30x8	140,-	175,-
RIEJU					
50 Crosser	Alle	038320	782x16,8x28x8	170,-	213,-
50 First	Alle	038320	782x16,8x28x8	170,-	213,-
50 Windy	Alle	038320	782x16,8x28x8	170,-	213,-
SANELI					
Bahne 50 (4 t.)	10"	Alle	038321	669x18x30x8	170,- 213,-
SUZUKI					
50 AJ ZZ Sepia S	95-97	038325	665x17,6x30x8,5	165,-	206,-
50 AH Adress	92-95	038338	664x16,5x	178,-	223,-
50 AP (R/S)	94-95	038338	664x16,5x	178,-	223,-
50 AP (T/V)	96-97	038303	779x16,9x30x8	175,-	219,-
50 AY Katana/WWR	97-98	038303	779x16,9x30x8	175,-	219,-
50 AY Katana/WWR AC/LC	99-00	038302	785x18,4x30x8	175,-	219,-
50 AY Katana/WWR AC/LC	01-02	038302	785x18,4x30x8	175,-	219,-
50 AY Katana AC	03-04	038303	779x16,9x30x8	175,-	219,-
50 AY Katana W LC	03-04	038302	785x18,4x30x8	175,-	219,-
50 AY Katana A	05-07	038302	785x18,4x30x8	175,-	219,-
50 Street Magic	97->	038302	785x18,4x30x8	175,-	219,-
50 UF Estilete	00->	038302	785x18,4x30x8	175,-	219,-
50 UX W Zillion	99->	038302	785x18,4x30x8	175,-	219,-
SYM					
50 DD Euro 2	03-10	038315	654x18x30x8,5	178,-	223,-
50 Fiddle		038321	669x18x30x8	170,-	213,-
50 Fiddle 2	08	038332	723x18x30x8,5	168,-	210,-
50 Fiddle 2 S	09-10	038335	766x18,3x28x8	228,-	285,-
50 Jet/Euro X EU 2/Sport X 2T	99-10	038329	737x18x30x8	185,-	231,-
50 Jungle	99-00	038329	737x18x30x8	185,-	231,-
50 Mio	06-10	038330	678x18,3x28x8	158,-	198,-
50 Red Devil	99->	038329	737x18x30x8	185,-	231,-
50 Super Fantasy	98-00	038321	669x18x30x8	170,-	213,-
50 Symphony	09-10	038335	766x18,3x28x8	228,-	285,-
TEXAS					
Chili 50 (4 t.)	12"	Alle	038327	729x18x30x8,5	228,- 285,-
City 50 (4 t.)	10"	Alle	038321	669x18x30x8	170,- 213,-
Flash 50 (4 t.)	10"	Alle	038321	669x18x30x8	170,- 213,-
Free 50 (4 t.)	10"	Alle	038321	669x18x30x8	170,- 213,-
TGB					
50 Arkoss	00->	038331	749x16,5x28x8	228,-	285,-



Bando drivremme

Bando Chemical Industries, med 17 fabrikker i 15 lande, har hovedkontor i Kobe i Japan. Bando er mere end 100 år gammelt. De er banebrydende i teknologier og udvikling af alle typer af transmissionsprodukter.

Bando er globalt førende inden for produktion af drivremme til både industri- og bilindustrien som OEM leverandør. Bando har også et internationalt netværk af industri- og automotive eftermarked distributører.

Kvalitet, service og værdi er grundlaget for Bandos filosofi. Med et stort fokus på udvikling af produkter, der er sikre og miljøvenlige for samfundet.

Bando drivremmar

Bando Chemical Industries, med 17 fabrikker i 15 länder, har huvudkontor i Kobe i Japan. Bando är mer än 100 år gammalt. De banbrytande inom tenologi och utveckling av alla typer av transmissionsprodukter.

Bando är ledande inom produktion av drivremmar till både industri- och bilindustri som global OEM leverantör. Bando har också ett internationellt nätverk av distributörer inom eftermarknaden för industri- och bilindustri.

Kvalitet, service och värde är grunden för Bandos filosofi. Med ett stort fokus på utveckling av produkter som är säkra och miljövänliga.



Mærke/model	Årg.	Drivrem OEM Varenr.	LxBxVxH Mål		
Mærke/modell	Årg.	Drivrem OEM Art.nr.	LxBxVxH Mått	DKK	SEK
TGB					
50 Laser/RS/R5 i	04>	038331	749x16,5x28x8	228,-	285:-
50 R-X Jet Fighter	06>	038331	749x16,5x28x8	228,-	285:-
50 101 S	04>	038331	749x16,5x28x8	228,-	285:-
TMP					
50 Baboon	Alle	038320	782x16,8x28x8	170,-	213:-
50 Gazelle	Alle	038320	782x16,8x28x8	170,-	213:-
TMS					
Retro 50 (4 t.)	10"	Alle	038321	669x18x30x8	170,- 213:-
S3 50 (4 t.)	10"	Alle	038321	669x18x30x8	170,- 213:-
Z2 50 (4 t.)	10"	Alle	038327	729x18x30x8,5	228,- 285:-
YAMAHA					
50 BW's	04-10	038317	738x16,5x28x8	145,-	181:-
50 BW's Bump	97-98	038317	738x16,5x28x8	145,-	181:-
50 BW's Next generation	97-06	038317	738x16,5x28x8	145,-	181:-
50 BW's Naked	03-10	038317	738x16,5x28x8	145,-	181:-
50 Jog R/Euro 2/LC	02-10	038317	738x16,5x28x8	145,-	181:-
50 Jog Artistic Special	Alle	038320	782x16,8x28x8	170,-	213:-
50 Jog Fine Selection	Alle	038320	782x16,8x28x8	170,-	213:-
50 Spy	95-98	038317	738x16,5x28x8	145,-	181:-
50 Slider	00-02	038317	738x16,5x28x8	145,-	181:-
50 Axis	95-96	038320	782x16,8x28x8	170,-	213:-
50 Why/Euro 1/2	98-10	038317	738x16,5x28x8	145,-	181:-
50 Neo's 2T/R/Euro 2	97-10	038317	738x16,5x28x8	145,-	181:-
50 Neo's 4T	09-10	038311	805x17,9x30x7,5	170,-	213:-
50 Aerox/L/R/Euro 2	97-10	038317	738x16,5x28x8	175,-	219:-
50XF Giggle 4T	08-11		919x22x		
YIYING					
Stranger 50 (4 t.)	10"	Alle	038321	669x18x30x8	170,- 213:-



**Mål på drivrem
 Mål av drivremmar**

L: Længde/längd
 B: Bredde/bredd
 H: Højde/höjd
 V°: Vinkel

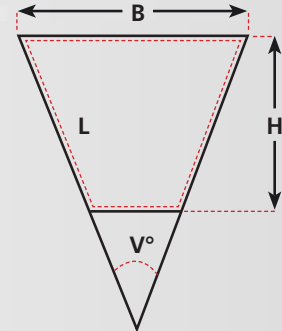

MAX
MC Parts



generic

XOR2 50CC RACE IDEO TRIGGER X **TRIGGER SM** XOR2 125CC

TRIGGER SM

30 el. 45 km/t

14.998,-

+ leveringsomkostninger

DEN INNOVATIVE SUPER MOTARD!

Det er tid til at brænde noget gummi af! TRIGGER SM er lig med avanceret og banebrydende teknologi – du er garanteret høj køreglæde og en præstation i topklasse! Udstyr, som "up-side-down" forgaffel, skivebrems, håndbeskyttere og lette alufælge, gør køreturen til en ren nydelse!

- MOTOR:** En cylinder, vandkølet, 2-takts motor. 49,6 cc. Kompression 7:1.
- TRANSMISSION:** 45 km: 6 gear, fodskifte. Kædetræk. 30 km: 3 gear, fodskifte. Kædetræk.
- STEL:** Rørramme i stål
- AFFJEDRING:** For: Upside down forgaffel Bag: Mono shock dæmper
- BREMSER:** For: Waveskive Ø 280 mm Bag: Waveskive Ø 220 mm
- HJUL:** For: 100/80 x 17 / Bag: 130/80 x 17
- LÆNGDE:** 2035 mm
- VÆGT:** 94 kg
- TANK:** 10 liter
- FARVE:** Sort ■ sort/orange ■ hvid/sort



Silkolene
 smøremidler anbefales af Generic Motors! ...

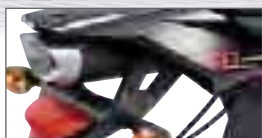

Gemt udstødning bag



Elektronisk instrumentbræt



Wavebremseskive for/bag

DESIGN AUSTRIA
 www.genericmotor.dk

SCANMI
 Importør: ScanMI ApS
 Tlf. +45 73 15 11 00

Forhandlere
 Återforsäljare
 s. 2

Stikord
 Sökord
 s. 4

Tøj/hjelme
 Kläder/
 hjälmar
 s. 6

Dæk og
 slanger
 Däck och
 slangar
 s. 15

Olje / spray
 Olja / spray
 s. 26

Kæder /
 tandhjul
 Kedjor /
 drev
 s. 43

Bremsedele
 Bromsdelar
 s. 48

Låse
 Lås
 s. 93

Batteri
 Batteri
 s. 96

Cylinder /
 topstykke
 Cylinder /
 topplock
 s. 105

Motordele
 Motordeklar
 s. 137

Karburator
 Luftfilter
 Förgasare
 Luftfilter
 s. 208

El-dele
 tændrør
 Elektriskt
 tændstift
 s. 222

Udstødning
 Avgassystem
 s. 246

Forgaffel
 Støddæmpere
 Framgaffel
 Støtdåmpare
 s. 260

Kabler
 Wire
 s. 266

Styr og
 greb
 Styre och
 handtag
 s. 272

Spejle
 Speglar
 s. 282

Blinklygter
 Baglygter
 Blinkers
 Baklygte
 s. 284

Støtteben
 Topboks, mm.
 Stödd
 Topbbox, mm
 s. 291

Rep. bøger
 værktøj
 Rep. böcker
 Verktyg
 s. 297



MÆRKE/MODEL	ÅRG.	Varenr.	Gram	Mål	DKK	SEK
MÆRKE/MODELL	ÅRG.	Art.NR.	Gram	Mått	DKK	SEK
ADLY						
Cat 50	Alle	035405	6,5 gr.	15*12 mm	49,-	61,-
Jet 50	Alle	035405	6,5 gr.	15*12 mm	49,-	61,-
Silver Fox 50	Alle	035405	6,5 gr.	15*12 mm	49,-	61,-
Super Sonic 50	Alle	035405	6,5 gr.	15*12 mm	49,-	61,-
Thunder Bike 50	Alle	035405	6,5 gr.	15*12 mm	49,-	61,-

APRILIA						
Amico 50	Alle	035406	7,0 gr.	15*12 mm	49,-	61,-
Area 51 LC 50	98->	035405	6,5 gr.	15*12 mm	49,-	61,-
Habana AC (Morini) 50	Alle	035455	5,5 gr.	17*12 mm	49,-	61,-
Rally AC 50	94->	035406	7,0 gr.	15*12 mm	49,-	61,-
Rally LC 50	97->	035405	6,5 gr.	15*12 mm	49,-	61,-
Scarabeo AC 50	Alle	035405	6,5 gr.	15*12 mm	49,-	61,-
Sonic AC 50	98->	035402	5,0 gr.	15*12 mm	49,-	61,-
Sonic LC 50	Alle	035402	5,0 gr.	15*12 mm	49,-	61,-
SR 50 45 km/t AC	->93	035406	7,0 gr.	15*12 mm	49,-	61,-
SR 50 45 km/t AC	->96	035406	7,0 gr.	15*12 mm	49,-	61,-
SR - Ditech 50	Alle	035458	7,0 gr.	17*12 mm	49,-	61,-
SR - www AC 50	97->	035406	7,0 gr.	15*12 mm	49,-	61,-
SR-Racing 50						
Stealth, Netscaper LC	Alle	035406	7,0 gr.	15*12 mm	49,-	61,-
SR-Replica LC (Minarelli) 50	->00	035406	7,0 gr.	15*12 mm	49,-	61,-
SR-Replica-2000 LC (Morini) 50	00->	035458	7,0 gr.	17*12 mm	49,-	61,-

ATALA						
Carosello 50	Alle	035405	6,5 gr.	15*12 mm	49,-	61,-
Hacker AT-12 50	Alle	035455	5,5 gr.	17*12 mm	49,-	61,-
Hacker LC 50	Alle	035455	5,5 gr.	17*12 mm	49,-	61,-
Skeggia 50	Alle	035455	5,5 gr.	17*12 mm	49,-	61,-

BAOTAIN						
BT-QT-8/11 50 (4 t.)	Alle	035427	6,5 gr.	16*13 mm	49,-	61,-
Rebel 50 (4.T.)	Alle	035427	6,5 gr.	16*13 mm	49,-	61,-
Supermoto 50 (4 t.)	Alle	035427	6,5 gr.	16*13 mm	49,-	61,-
Rocky 50 (4 t.)	Alle	035427	6,5 gr.	16*13 mm	49,-	61,-

BENELLI						
491 GT 50	97->	035405	6,5 gr.	15*12 mm	49,-	61,-
491 Sport 50	97->	035405	6,5 gr.	15*12 mm	49,-	61,-
K2/LC 50	Alle	035405	6,5 gr.	15*12 mm	49,-	61,-

BETA						
Ark AC 50	Alle	035403	5,5 gr.	15*12 mm	49,-	61,-
Ark/LC 50	Alle	035403	5,5 gr.	15*12 mm	49,-	61,-

CAGIVA						
Progress (Derbi) 50	Alle	035456	6,0 gr.	17*12 mm	49,-	61,-
City 50	Alle	035407	7,5 gr.	15*12 mm	49,-	61,-

CPI						
Hussar JR 50	->03	035402	5,0 gr.	15*12 mm	49,-	61,-
Hussar JR 50	03->	035404	6,0 gr.	15*12 mm	49,-	61,-
Oliver JR/City 50 (Euro 2)	Alle	035404	6,0 gr.	15*12 mm	49,-	61,-
Popcorn JP 50	Alle	035402	5,0 gr.	15*12 mm	49,-	61,-
Popcorn JP 50	Alle	035404	6,0 gr.	15*12 mm	49,-	61,-

DERBI						
Atlantis 50 - 30 km	Alle	035458	7,0 gr.	17*12 mm	49,-	61,-
Atlantis 50 (Piaggio) 30 km/t	03->	035486	6,0gr.	19*15,5 mm	49,-	61,-
GP1 50 (Piaggio) 30 km/t	03->	035486	6,0gr.	19*15,5 mm	49,-	61,-
Hunter 50	Alle	035457	6,5 gr.	17*12 mm	49,-	61,-
Manhattan 50	Alle	035457	6,5 gr.	17*12 mm	49,-	61,-
MotoGP(GP1) 50	Alle	035458	7,0 gr.	17*12 mm	49,-	61,-
Paddock 50	Alle	035457	6,5 gr.	17*12 mm	49,-	61,-
Predator LC 50	Alle	035457	6,5 gr.	17*12 mm	49,-	61,-
Vamos (Morini) 50	Alle	035457	6,5 gr.	17*12 mm	49,-	61,-

FYM						
QT 50	Alle	035427	6,5 gr.	16*13 mm	49,-	61,-

GENERIC						
Ideo 50 - 30/45 km/t	Alle	035403	5,5 gr.	15*12 mm	49,-	61,-
Xor 50 - 30/45 km/t	Alle	035403	5,5 gr.	15*12 mm	49,-	61,-

GIANTCO						
Sprint 50	Alle	035427	6,5 gr.	16*13 mm	49,-	61,-
Stealth 50	Alle	035427	6,5 gr.	16*13 mm	49,-	61,-
Venus 50	Alle	035427	6,5 gr.	16*13 mm	49,-	61,-

MÆRKE/MODEL	ÅRG.	Varenr.	Gram	Mål	DKK	SEK
MÆRKE/MODELL	ÅRG.	Art.NR.	Gram	Mått	DKK	SEK
GILERA						
DNA LC 50	Alle	035488	7,0 gr.	19*15,5 mm	49,-	61,-
ICE AC 50	Alle	035488	7,0 gr.	19*15,5 mm	49,-	61,-
Runner, 30 km/t AC 50	Alle	035485	5,5 gr.	19*15,5 mm	49,-	61,-
Runner, LC 50	Alle	035485	5,5 gr.	19*15,5 mm	49,-	61,-
Runner PJ 50 - 45 km/t	03->	035488	7,0 gr.	19*15,5 mm	49,-	61,-
Runner SP LC 50	02->	035488	7,0 gr.	19*15,5 mm	49,-	61,-
Stalker 50 - 30 km/t	Alle	035487	6,5 gr.	19*15,5 mm	49,-	61,-
Typhoon 50 - 30/45 km/t	->01	035431	8,5 gr.	16*13 mm	49,-	61,-
Typhoon X 50 - 30/45 km/t	02->	035488	7,0 gr.	19*15,5 mm	49,-	61,-

HONDA						
SFX 50	Alle	035432	9,0 gr.	16*13 mm	49,-	61,-
Sky 50	Alle	035424	5,0 gr.	16*13 mm	49,-	61,-
Vision Met In 50	Alle	035430	8,0 gr.	16*13 mm	49,-	61,-
Vision SA 50 50	Alle	035430	8,0 gr.	16*13 mm	49,-	61,-
Wallaroo 50	Alle	035431	8,5 gr.	16*13 mm	49,-	61,-
X8-R 50	Alle	035432	9,0 gr.	16*13 mm	49,-	61,-

ITALJET						
Formula 50	Alle	035455	5,5 gr.	17*12 mm	49,-	61,-
Velocifero 50	Alle	035456	6,0 gr.	17*12 mm	49,-	61,-

KEEWAY						
F-act 50	Alle	035403	5,5 gr.	15*12 mm	49,-	61,-
Flash 50	Alle	035403	5,5 gr.	15*12 mm	49,-	61,-
Focus 50 - 30/45 km/t	Alle	035403	5,5 gr.	15*12 mm	49,-	61,-
Matrix 50 - 30/45 km/t	Alle	035403	5,5 gr.	15*12 mm	49,-	61,-

KYMCO						
K-12 50	Alle	035431	8,5 gr.	16*13 mm	49,-	61,-

MALAGUTI						
F10 AC 50	Alle	035405	6,5 gr.	15*12 mm	49,-	61,-
F12 Phantom AC 50	Alle	035405	6,5 gr.	15*12 mm	49,-	61,-
F15 Firefox LC 50	Alle	035405	6,5 gr.	15*12 mm	49,-	61,-

PEUGEOT						
Buxy 50	94->	035432	9,0 gr.	16*13 mm	49,-	61,-
Elyseo 50		035432	9,0 gr.	16*13 mm	49,-	61,-
Elystar 50	Alle	035432	9,0 gr.	16*13 mm	49,-	61,-
Fox 50	Alle	035432	9,0 gr.	16*13 mm	49,-	61,-
Speedake 50	95->	035432	9,0 gr.	16*13 mm	49,-	61,-
Speedfight -2 AC 50	03->	035432	9,0 gr.	16*13 mm	49,-	61,-
Speedfight AC 50	95->	035432	9,0 gr.	16*13 mm	49,-	61,-
Speedfight LC 50	Alle	035432	9,0 gr.	16*13 mm	49,-	61,-
Squab 50	95->	035432	9,0 gr.	16*13 mm	49,-	61,-
Trekker 50	98->	035432	9,0 gr.	16*13 mm	49,-	61,-
Trekker/Metal X 50	03->	035432	9,0 gr.	16*13 mm	49,-	61,-
Vivacity 50	Alle	035432	9,0 gr.	16*13 mm	49,-	61,-
Zenith 50	94->	035432	9,0 gr.	16*13 mm	49,-	61,-

PEXMA						
KD 50 (4 t.)	Alle	035427	6,5 gr.	16*13 mm	49,-	61,-

PGO						
Big Max 50	Alle	035431	8,5 gr.	16*13 mm	49,-	61,-
Black Magic 50	Alle	035429	7,5 gr.	16*13 mm	49,-	61,-
Bubu 50	Alle	035429	7,5 gr.	16*13 mm	49,-	61,-
Comet 50	Alle	035429	7,5 gr.	16*13 mm	49,-	61,-
Dr. Big 50	Alle	035429	7,5 gr.	16*13 mm	49,-	61,-
Galaxy 50	Alle	035429	7,5 gr.	16*13 mm	49,-	61,-
Hot-50 50	Alle	035429	7,5 gr.	16*13 mm	49,-	61,-
Ligero 50	Alle	035429	7,5 gr.	16*13 mm	49,-	61,-
PMS 50	Alle	035429	7,5 gr.	16*13 mm	49,-	61,-
PMX 50	Alle	035429	7,5 gr.	16*13 mm	49,-	61,-
Rodo Show 50	Alle	035429	7,5 gr.	16*13 mm	49,-	61,-
T-Rex 50	Alle	035429	7,5 gr.	16*13 mm	49,-	61,-
Tornado 50	Alle	035429	7,5 gr.	16*13 mm	49,-	61,-

PIAGGIO/VESPA						
ET2 50	97->	035431	8,5 gr.	16*13 mm	49,-	61,-
ET2 50	00->	035491	8,5 gr.	19*15,5 mm	49,-	61,-
NRG Extreme MC3-LC 50	Alle	035489	7,5 gr.	19*15,5 mm	49,-	61,-
NRG MC-2 LC 50	94->	035428	7,0 gr.	16*13 mm	49,-	61,-
NTT 50		035431	8,5 gr.	16*13 mm	49,-	61,-
Typhoon 50	Alle	035431	8,5 gr.	16*13 mm	49,-	61,-
Typhoon-X 50	02->	035488	7,0 gr.	19*15,5 mm	49,-	61,-
Zip 2000 50	00->	035485	5,5 gr.	19*15,5 mm	49,-	61,-
Zip 50	93->	035431	8,5 gr.	16*13 mm	49,-	61,-

STRANGER						
X-fight 50 (4 t.)	Alle	035427	6,5 gr.	16*13 mm	49,-	61,-



Forhandlere
Återförsäljare
s. 2

Stikord
Sökord
s. 4

Tøj/hjelme
Klæder/
hjelmar
s. 6

Dæk og
slanger
Dæk og
slangar
s. 15

Olie / spray
Olja / spray
s. 26

Kæder /
tandhjul
Kedjor /
drev
s. 43

Bremsedele
Bromsdelar
s. 48

Låse
Lås
s. 93

Batteri
Batteri
s. 96

Cylinder /
topstykke
Cylinder /
topplock
s. 105

Motordele
Motordeklar
s. 137

Karburator
Luffilter
Förgasare
Luffilter
s. 208

El-dele
tændrør
Elektriskt
tændstift
s. 222

Udstødning
Avgassystem
s. 246

Forgaffel
Støddæmpere
Framgaffel
Støtdämpare
s. 260

Kabler
Wire
s. 266

Styr og
greb
Styre och
handtag
s. 272

Spejle
Speglar
s. 282

Blinklygter
Baglygter
Blinkers
Baklykte
s. 284

Støtteben
Topboks, mm.
Stödd
Toppbox, mm
s. 291

Rep. bøger
værktøj
Rep. böcker
Verktyg
s. 297

MÆRKE/MODEL	ÅRG.	Varenr.	Gram	Mål		
MÄRKE/MODELL	ÅRG.	Art.NR.	Gram	Mått	DKK	SEK
SUZUKI						
Adress AP 50	Alle	035456	6,0 gr.	17*12 mm	49,-	61,-
Estilete 50	Alle	035457	6,5 gr.	17*12 mm	49,-	61,-
Katana AY AC 50	Alle	035456	6,0 gr.	17*12 mm	49,-	61,-
Katana AY LC 50	Alle	035456	6,0 gr.	17*12 mm	49,-	61,-
Street Magic 50	Alle	035456	6,0 gr.	17*12 mm	49,-	61,-
Zillion LC 50	Alle	035456	6,0 gr.	17*12 mm	49,-	61,-

SYM						
Jet 50	Alle		7,5 gr.	17*12 mm		
Super Fancy 50	Alle	035457	6,5 gr.	17*12 mm	49,-	61,-

TOBILINER						
QT 50 (4 t.)	Alle	035427	6,5 gr.	16*13 mm	49,-	61,-

TEXAS 30/50 (4 T.)						
Chili 50 (4 t.)	Alle	035427	6,5 gr.	16*13 mm	49,-	61,-

YAMAHA						
Aerox 50	97->	035403	5,5 gr.	15*12 mm	49,-	61,-
Aerox R 50	03->	035403	5,5 gr.	15*12 mm	49,-	61,-
Axis 50	95->	035407	7,5 gr.	15*12 mm	49,-	61,-
Bump 50	97->	035406	7,0 gr.	15*12 mm	49,-	61,-
BW's 50	Alle	035405	6,5 gr.	15*12 mm	49,-	61,-
BW's N.G. 50	Alle	035405	6,5 gr.	15*12 mm	49,-	61,-
Jog 30,						
Artistic - Fine Selection 50	Alle	035406	7,0 gr.	15*12 mm	49,-	61,-
Jog 45,						
Artistic - Fine Selection 50	Alle	035402	5,0 gr.	15*12 mm	49,-	61,-
Jog Space Innovation 50	98->	035405	6,5 gr.	15*12 mm	49,-	61,-
Jog-R AC 50	03->	035405	6,5 gr.	15*12 mm	49,-	61,-
Jog-RR LC 50	03->	035405	6,5 gr.	15*12 mm	49,-	61,-
Neo's 50	Alle	035405	6,5 gr.	15*12 mm	49,-	61,-
Slider 50	01->	035405	6,5 gr.	15*12 mm	49,-	61,-
Spy 50	Alle	035406	7,0 gr.	15*12 mm	49,-	61,-
Why 50	99->	035405	6,5 gr.	15*12 mm	49,-	61,-

Specialfremstillede originalruller til direkte montering i din variator.

Specialtillverkade originalrullar för montering i din variator.



MAX
MC Parts





STANDARD:

Varenr.	Gram	Str.	DKK	SEK
035413	3	15*12 mm	49,-	61,-
035412	3,5	15*12 mm	49,-	61,-
035400	4	15*12 mm	49,-	61,-
035401	4,5	15*12 mm	49,-	61,-
035402	5	15*12 mm	49,-	61,-
035403	5,5	15*12 mm	49,-	61,-
035404	6	15*12 mm	49,-	61,-
035405	6,5	15*12 mm	49,-	61,-
035406	7	15*12 mm	49,-	61,-
035407	7,5	15*12 mm	49,-	61,-
035408	8	15*12 mm	49,-	61,-
035409	8,5	15*12 mm	49,-	61,-
035410	9	15*12 mm	49,-	61,-
035411	10	15*12 mm	49,-	61,-
035420	3	16*13 mm	49,-	61,-
035421	3,5	16*13 mm	49,-	61,-
035422	4	16*13 mm	49,-	61,-
035423	4,5	16*13 mm	49,-	61,-
035424	5	16*13 mm	49,-	61,-
035425	5,5	16*13 mm	49,-	61,-
035426	6	16*13 mm	49,-	61,-
035427	6,5	16*13 mm	49,-	61,-
035428	7	16*13 mm	49,-	61,-
035429	7,5	16*13 mm	49,-	61,-
035430	8	16*13 mm	49,-	61,-
035431	8,5	16*13 mm	49,-	61,-
035432	9	16*13 mm	49,-	61,-
035433	10	16*13 mm	49,-	61,-
035450	3	17*12 mm	49,-	61,-
035451	3,5	17*12 mm	49,-	61,-
035452	4	17*12 mm	49,-	61,-
035453	4,5	17*12 mm	49,-	61,-
035454	5	17*12 mm	49,-	61,-
035455	5,5	17*12 mm	49,-	61,-
035456	6	17*12 mm	49,-	61,-
035457	6,5	17*12 mm	49,-	61,-
035458	7	17*12 mm	49,-	61,-
035459	7,5	17*12 mm	49,-	61,-
035460	8	17*12 mm	49,-	61,-
035461	8,5	17*12 mm	49,-	61,-
035462	9	17*12 mm	49,-	61,-
035463	10	17*12 mm	49,-	61,-
035480	3	19*15,5 mm	49,-	61,-
035481	3,5	19*15,5 mm	49,-	61,-
035482	4	19*15,5 mm	49,-	61,-
035483	4,5	19*15,5 mm	49,-	61,-
035484	5	19*15,5 mm	49,-	61,-
035485	5,5	19*15,5 mm	49,-	61,-
035486	6	19*15,5 mm	49,-	61,-
035487	6,5	19*15,5 mm	49,-	61,-
035488	7	19*15,5 mm	49,-	61,-
035489	7,5	19*15,5 mm	49,-	61,-
035490	8	19*15,5 mm	49,-	61,-
035491	8,5	19*15,5 mm	49,-	61,-
035492	9	19*15,5 mm	49,-	61,-
035493	9,5	19*15,5 mm	49,-	61,-
035494	10	19*15,5 mm	49,-	61,-

Leolinei



RACING:

Varenr.	Gram	Str.	DKK	SEK
035100	2,3	15*12 mm	71,-	89,-
035101	3,3	15*12 mm	71,-	89,-
035102	3,5	15*12 mm	71,-	89,-
035103	4,3	15*12 mm	71,-	89,-
035104	4,7	15*12 mm	71,-	89,-
035105	5	15*12 mm	71,-	89,-
035106	5,3	15*12 mm	71,-	89,-
035107	5,8	15*12 mm	71,-	89,-
035108	6,3	15*12 mm	71,-	89,-
035109	6,6	15*12 mm	71,-	89,-
035110	7,2	15*12 mm	71,-	89,-
035111	7,7	15*12 mm	71,-	89,-
035112	8,1	15*12 mm	71,-	89,-
035113	8,6	15*12 mm	71,-	89,-
035120	2,7	16*13 mm	71,-	89,-
035121	3,6	16*13 mm	71,-	89,-
035122	4	16*13 mm	71,-	89,-
035123	4,7	16*13 mm	71,-	89,-
035124	5,1	16*13 mm	71,-	89,-
035125	5,5	16*13 mm	71,-	89,-
035126	5,7	16*13 mm	71,-	89,-
035127	6,2	16*13 mm	71,-	89,-
035128	6,7	16*13 mm	71,-	89,-
035129	7	16*13 mm	71,-	89,-
035130	7,5	16*13 mm	71,-	89,-
035131	8	16*13 mm	71,-	89,-
035132	8,5	16*13 mm	71,-	89,-
035133	9	16*13 mm	71,-	89,-
035140	3	17*13,5 mm	71,-	89,-
035141	4	17*13,5 mm	71,-	89,-
035142	4,3	17*13,5 mm	71,-	89,-
035143	5,1	17*13,5 mm	71,-	89,-
035144	5,5	17*13,5 mm	71,-	89,-
035145	5,8	17*13,5 mm	71,-	89,-
035146	6,1	17*13,5 mm	71,-	89,-
035147	6,6	17*13,5 mm	71,-	89,-
035148	7	17*13,5 mm	71,-	89,-
035149	7,4	17*13,5 mm	71,-	89,-
035150	7,9	17*13,5 mm	71,-	89,-
035151	8,4	17*13,5 mm	71,-	89,-
035152	9	17*13,5 mm	71,-	89,-
035153	9,4	17*13,5 mm	71,-	89,-

Varenr.	Gram	Str.	DKK	SEK
035160	3	17*12 mm	71,-	89,-
035161	3,6	17*12 mm	71,-	89,-
035162	4	17*12 mm	71,-	89,-
035163	4,6	17*12 mm	71,-	89,-
035164	5,2	17*12 mm	71,-	89,-
035165	5,6	17*12 mm	71,-	89,-
035166	6	17*12 mm	71,-	89,-
035167	6,3	17*12 mm	71,-	89,-
035168	6,8	17*12 mm	71,-	89,-
035169	7,2	17*12 mm	71,-	89,-
035170	7,7	17*12 mm	71,-	89,-
035171	8,3	17*12 mm	71,-	89,-
035172	8,7	17*12 mm	71,-	89,-
035173	9,2	17*12 mm	71,-	89,-
035180	3,7	19*15,5 mm	71,-	89,-
035181	4	19*15,5 mm	71,-	89,-
035182	4,3	19*15,5 mm	71,-	89,-
035183	4,8	19*15,5 mm	71,-	89,-
035184	5,3	19*15,5 mm	71,-	89,-
035185	5,7	19*15,5 mm	71,-	89,-
035186	6	19*15,5 mm	71,-	89,-
035187	6,5	19*15,5 mm	71,-	89,-
035188	6,8	19*15,5 mm	71,-	89,-
035189	7,2	19*15,5 mm	71,-	89,-
035190	7,5	19*15,5 mm	71,-	89,-
035191	7,8	19*15,5 mm	71,-	89,-
035192	8,3	19*15,5 mm	71,-	89,-
035193	8,7	19*15,5 mm	71,-	89,-



TOP RACING



 **Glidestykker for bagplade**
 **Glidstycke för bakplåt**

Passer til alle topracing variatorer.
Leveres i sæt.

Varenr. 034470

 **DKK** 21,-
 **SEK** 26,-



 **Standardsortiment**
 **Standard sortiment**

Variatorruller Ø15x12 bruges standard til: Aprilia, Malaguti, MBK, Itajet, Yamaha, Benelli, Adly, Beta, Cagiva
 Indeholder: 12x4,5 g - 12x5 g - 12 x 5,5 g - 12x6,5 g - 12x7 g - 12x7,5 g - 12x8,5 g - 12x9 g - 12x10 g.
 4x+15% grøn koblingsfjeder, kort
 6x+15% grøn koblingsfjeder lang
 4x30% rød koblingsfjeder, kort
 6x+30% rød, koblingsfjeder, lang
 4x+50% blå koblingsfjeder, kort
 6x+50% blå koblingsfjeder, lang
 9xglidestykker

Varenr. 035051

 **DKK** 733,-
 **SEK** 916,-



 **Standardsortiment**
 **Standard sortiment**

Variatorruller Ø16x13 bruges standard til: Honda, Peugeot, PGO, Sym, Vespa, Piaggio, Kymco.
 Indeholder: 12x4,5 g - 12x5 g - 12 x 5,5 g - 12x6,5 g - 12x7 g - 12x7,5 g - 12x8,5 g - 12x9 g - 12x10 g.
 4x+15% grøn koblingsfjeder, kort
 6x+15% grøn koblingsfjeder lang
 4x30% rød koblingsfjeder, kort
 6x+30% rød, koblingsfjeder, lang
 4x+50% blå koblingsfjeder, kort
 6x+50% blå koblingsfjeder, lang
 9xglidestykker

Varenr. 035052

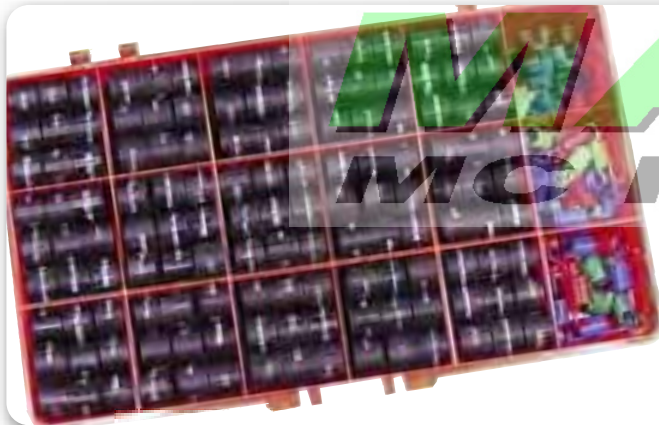

 **DKK** 733,-
 **SEK** 916,-



 **Kæmpe sortiment**
 **Stort sortiment**

Variatorruller Ø16x13 bruges standard til: Honda, Peugeot, PGO, Sym, Vespa, Piaggio, Kymco.
 Indeholder: 18x3,5 g - 18x4.0 g - 18x4,5 g - 18x5.0 g - 18x5,5 g - 18x6.0 g - 18x6,5 g - 18x7.0 g - 18x7,5 g - 18x8.0 g - 18x8.5 g - 18x9.0 g - 18x9,5 g - 18x10.0 g - 18x10.5 g.
 4x+15% grøn koblingsfjeder, kort
 6x+15% grøn koblingsfjeder lang
 4x30% rød koblingsfjeder, kort
 6x+30% rød, koblingsfjeder, lang
 4x+50% blå koblingsfjeder, kort
 6x+50% blå koblingsfjeder, lang
 9xglidestykker

Varenr. 035050

 **DKK** 1258,-
 **SEK** 1573,-



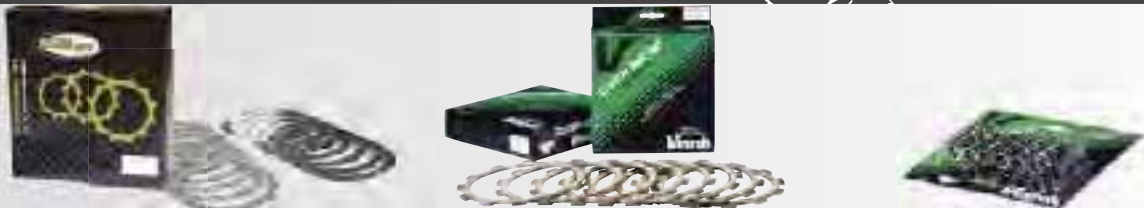

Märke/model	Årg.	Koblingsplader		OEMnr.	Antal	Koblingsfjedre		OEMnr.	Antal				
Märke/model	Årg.	Lameller	Ref.nr.	OEMnr.	Antal	DKK	Fjädrar	Art.nr.	Ref.nr.	OEMnr.	Antal	DKK	SEK
		Art.nr.					SEK						
APRILIA													
Classic 50	92-02	031400		8206 322	3 stk.	99,-	124,-	032401		8206 258	4 stk.	99,-	124,-
MX 50	03-06	031400		8206 322	3 stk.	99,-	124,-	032401		8206 258	4 stk.	99,-	124,-
RS 50	Alle	031400		8206 322	3 stk.	99,-	124,-	032401		8206 258	4 stk.	99,-	124,-
RS 50	06-11	031401		00H02601161	4 stk.	99,-	124,-	032400		00H02600211	5 stk.	99,-	124,-
RX 50	91-06	031400		8206 322	3 stk.	99,-	124,-	032401		8206 258	4 stk.	99,-	124,-
RX 50	06-10	031401		00H02601161	4 stk.	99,-	124,-	032400		00H02600211	5 stk.	99,-	124,-
SX 50	07-09	031401		00H02601161	4 stk.	99,-	124,-	032400		00H02600211	5 stk.	99,-	124,-
SX 50	06-10	031401		00H02601161	4 stk.	99,-	124,-	032400		00H02600211	5 stk.	99,-	124,-
DERBI													
GPR 50 R / Racing	99-06	031401		00H02601161	4 stk.	99,-	124,-	032400		00H02600211	5 stk.	99,-	124,-
GPR 50 Nude	04-06	031401		00H02601161	4 stk.	99,-	124,-	032400		00H02600211	5 stk.	99,-	124,-
GPR 50 Replica	99-06	031401		00H02601161	4 stk.	99,-	124,-	032400		00H02600211	5 stk.	99,-	124,-
Senda 50 R	99-05	031401		00H02601161	4 stk.	99,-	124,-	032400		00H02600211	5 stk.	99,-	124,-
Senda 50 SM X-treme	99-06	031401		00H02601161	4 stk.	99,-	124,-	032400		00H02600211	5 stk.	99,-	124,-
GILERA													
RCR Cross 50	Alle	031401		00H02601161	4 stk.	99,-	124,-	032400		00H02600211	5 stk.	99,-	124,-
SMT 50	Alle	031401		00H02601161	4 stk.	99,-	124,-	032400		00H02600211	5 stk.	99,-	124,-
HONDA													
CD 50	Alle	031020	VC-113	22201-035-010	2 stk.	99,-	124,-	032012	SK-115		4 stk.	73,-	91,-
MB 50	Alle	031031	VC-150	22201-166-000	3 stk.	199,-	249,-						
MT 50	Alle	031031	VC-150	22201-166-000	3 stk.	199,-	249,-						
ST-50 DAX	Alle	031020	VC-113	22201-035-010	2 stk.	99,-	124,-	032013	VC-136		4 stk.	88,-	110,-
RIEJU													
MRX PRO 50	Alle	031349			5 stk.	99,-	124,-	032401			4 stk.	99,-	124,-
MRX-50	Alle	031349			5 stk.	99,-	124,-	032401			4 stk.	99,-	124,-
RS2-50	Alle	031349			5 stk.	99,-	124,-	032401			4 stk.	99,-	124,-
SMX-50	Alle	031349			5 stk.	99,-	124,-	032401			4 stk.	99,-	124,-
Spike-50	Alle	031349			5 stk.	99,-	124,-	032401			4 stk.	99,-	124,-
SUZUKI													
DM 50 X Samurai	Alle	031218	VP-3010x2		2 stk.	99,-	124,-						
K-50 B-DB	Alle	031217	VP-3013x3	21441-22001	3 stk.	99,-	124,-						
RMX 50	Alle	031238		21441-13A01	3 stk.	99,-	124,-	032226		09440-15008	5 stk.	99,-	124,-
SMX Supermotad 50	Alle	031238		21441-13A01	3 stk.	99,-	124,-	032226		09440-15008	5 stk.	99,-	124,-
TS 50 X	Alle		VC-328	21441-04700	3 stk.	99,-	124,-						
YAMAHA													
DT-50/DT 50R	Alle	031316	VC-205	131-16321-00	2 stk.	81,-	101,-	032313	SK-218		4 stk.	85,-	106,-
DT 50 LC	98->	031349		3NC-E6331-00	4 stk.	99,-	124,-	032401		90501-20859	4 stk.	99,-	124,-
DX 50, 4 gear	Alle	031316	VC-205	131-16321-00	2 stk.	81,-	101,-	032313	SK-218		4 stk.	85,-	106,-
FS-1 50 2+4 gear	Alle	031316	VC-205	131-16321-00	2 stk.	81,-	101,-	032313	SK-218		4 stk.	85,-	106,-
TZR 50	98->	031349		3NC-E6331-00	5 stk.	99,-	124,-	032401		90501-20859	4 stk.	99,-	124,-





Märke/model	Prod. årg.	KOBLINGSPLADER Varenr.	KOPPLINGSLAMELLER		KOBLINGSFJEDRE Varenr.		
Märke/modell	Prod. årg.	Art.nr.	DKK	SEK	Art.nr.	DKK	SEK
APRILIA							
AF1 Futura 50	90-92	CK2348	218,-	273,-			
Classic 50	92-01	CK2348	218,-	273,-			
Europa 50	90-92	CK2348	218,-	273,-			
MX 50	03-05	CK2348	218,-	273,-			
Pegaso 50	92-94	CK2348	218,-	273,-			
RS 50	93-05	CK2348	218,-	273,-			
RX3-5	91-94	CK2348	218,-	273,-			
RX 50	91-06	CK2348	218,-	273,-			
Tuono 50	03-04	CK2348	218,-	273,-			
HONDA							
C 50 All models	82-93	CK1148	125,-	156,-			
C 50 (Single seat model)	95	CK1148	125,-	156,-			
C 50 P/S/V/X/Y/1/2	96-02	CK1148	125,-	156,-			
MB 50	80-82	CK1150	189,-	236,-	CSK003	122,-	153,-
MTX 50 SC	83-87	CK1150	189,-	236,-	CSK003	122,-	153,-
MBX 50 SD/SF	83-85	CK1150	189,-	236,-	CSK003	122,-	153,-
ST 50 J/K "DAX"	78-93	CK1148	125,-	156,-			
XR 50 R1/R2/R3	01-03	CK1148	125,-	156,-			
XR 50 M5 (AD14) Motard	06	CK1150	189,-	236,-	CSK048	122,-	153,-
XZ 50 1/2 APE-AC16	01-02	CK1150	189,-	236,-	CSK048	122,-	153,-
SUZUKI							
TS 50 KN/ERKT/ERKX/ERKZ/ERKD	79-83	CK3328	189,-	236,-	CSK001	122,-	153,-
TS 50 XKE/XKG/XKH/XKJ/XKM/XKR	84-02	CK3349	247,-	309,-	CSK001	122,-	153,-
YAMAHA							
FS 1 E/FS 1 DX 50	74-80	CK2205	138,-	173,-	CSK042	122,-	153,-
FS 1 50	87-90	CK2205	138,-	173,-	CSK042	122,-	153,-
FS 1 SE 50	81-82	CK2205	138,-	173,-	CSK042	122,-	153,-
DT 50 M	78-79	CK2206	189,-	236,-	CSK042	122,-	153,-
DT 50 M/MX	80-95	CK2205	138,-	173,-	CSK042	122,-	153,-
DT 50 LC	98	CK2206	189,-	236,-	CSK042	122,-	153,-
DT 50 R	97-08	CK2348	218,-	273,-			
DT 50 X (Supermotard)	04-08	CK2348	218,-	273,-			
RD 50 M	78-79	CK2206	189,-	236,-	CSK042	122,-	153,-
TZR 50 (5DU1/3)	97-00	CK2349	266,-	333,-			
TZR 50 (5WX1)	03-08	CK2349	266,-	333,-			

■ Nästen identisk med de originale koblingsplader. CK-serien er en kork baseret belægning med aluminium partikler til at øget holdbarhed og varmebestandighed. Materialet er hårdt komprimeret for at undgå at svulme op og glidende kobling. Kitteret indeholder et komplet sæt friktionsplader.

■ Nästan identisk med de ursprungliga kopplings plattorna. CK-serien är en kork baserad koppling med kork partiklar belagda med aluminium för att öka hållbarheten och motverka värme. Materialet komprimeras hårt för att undvika att svälla och ger en smidig koppling. Paketet innehåller en komplett uppsättning av kopplings plattor.

 **KOBLINGSKIT I KEVLAR**
 **KOPPLINGSSATS I KEVLAR**



Märke/model	Prod. årg.	RACEKOBLINGSKIT Varenr.	RACER KOPPLINGSSATS	
Märke/modell	Prod. årg.	Art.nr.	DKK	SEK
APRILIA				
SX 50	07>	031403	225,-	281,-
DERBI				
GPR 50 R	Alle	031403	225,-	281,-
Senda 50 R	Alle	031403	225,-	281,-
GILERA				
RCR 50	Alle	031403	225,-	281,-
SMT 50	Alle	031403	225,-	281,-

Märke/model	Prod. årg.	RACEKOBLINGSKIT Varenr.	RACER KOPPLINGSSATS	
Märke/modell	Prod. årg.	Art.nr.	DKK	SEK
APRILIA				
Classic 50 (AM6)	Alle	031402	178,-	223,-
MX 50 (AM6)	Alle	031402	178,-	223,-
RS 50 (AM6)	Alle	031402	178,-	223,-
RX 50 (AM6)	Alle	031402	178,-	223,-

■ Kevlarkoblingen er til brug på både tunede og STDmotorer. Kombineret med de medfølgende fjedre samt stållameller giver det et optimalt greb!

■ Kevlarkopplingen passar både tunade och standardmotorer. Kombinerat med de medföljande fjädrarna och stållamellerna ger det ett optimalt grepp!

Forhandlere
Återförsäljare
s. 2

Stikord
Sökord
s. 4

Tøj/hjelme
Kläder/
hjälm
s. 6

Dæk og
slanger
Däck och
slangor
s. 15

Olje / spray
olja / spray
s. 26

Kæder /
tandhjul
kedjor /
drev
s. 43

Bremselede
Bromsdelar
s. 48

Låse
Lås
s. 93

Batteri
Batteri
s. 96

Cylinder /
topstykke
Cylinder /
topplöck
s. 105

Motordele
Motordeelar
s. 137

Karburator
- Luftfilter
Förgasare
- Luftfilter
s. 208

El-dele
tændrør
Elektriskt
tändstift
s. 222

Udstødning
Avgassystem
s. 246

Forgaffel
Støddæmpere
Framgaffel
Støtdämpare
s. 260

Kabler
Wire
s. 266

Styr og
greb
Styre och
handtag
s. 272

Spejle
Speglar
s. 282

Blinklygter
Baglygter
Blinkers
Baklykte
s. 284

Støtteben
Topboks, mm.
Stödd
Topbbox, mm
s. 291

Rep. bøger
værktøj
Rep. böcker
Verktyg
s. 297

MÆRKE/MODEL	ÅRG.	Varenr.		
MÆRKE/MODELL	ÅRG.	Art.NR.	DKK	SEK
ADLY				
Cat 50	Alle	033584	722,-	903,-
Jet 50	Alle	033584	722,-	903,-
Silver Fox 50	Alle	033584	722,-	903,-
Super Sonic 50	Alle	033584	722,-	903,-
Thunder Bike 50	Alle	033584	722,-	903,-

APRILIA				
Amico 50	96->	033584	722,-	903,-
Area 51 LC 50	98->	033584	722,-	903,-
Gulliver 50	96->	033584	722,-	903,-
Rally AC 50	96->	033584	722,-	903,-
Scarabeo 50	96->	033584	722,-	903,-
Sonic AC 50	Alle	033584	722,-	903,-
Sonic LC 50	Alle	033584	722,-	903,-
SR - www AC 50	97->	033584	722,-	903,-
SR-50 AC/LC	96->	033584	722,-	903,-
SR-Racing 50, Stealth, Netscaper LC	Alle	033584	722,-	903,-
SR-Replica LC (Minarelli) 50	->00	033584	722,-	903,-

ATALA				
Carosello 50	96->	033584	722,-	903,-
Hacker AT-12 50	Alle	033581	722,-	903,-
Hacker LC 50	Alle	033581	722,-	903,-
Skeggia 50	Alle	033581	722,-	903,-

AVANTI				
9 N 50 (4 t.)*	Alle	033586	313,-	391,-
Sport Classic 50 (4 t.)*	Alle	033586	313,-	391,-
Eagle 50 (4 t.)*	Alle	033586	313,-	391,-
Avanti Wolf 50 (4 t.)*	Alle	033586	313,-	391,-

BAOTAIN				
BT49QT-7 50 (4 t.)*	Alle	033586	313,-	391,-
BT49QT-9 50 (4 t.)*	Alle	033586	313,-	391,-
BT49QT-11 50 (4 t.)*	Alle	033586	313,-	391,-
BT49QT-12C 50 (4 t.)*	Alle	033586	313,-	391,-
BT49QT-12 50 (4 t.)*	Alle	033586	313,-	391,-

BENDA				
Scout 50 (4 t.)*	Alle	033586	313,-	391,-

BENELLI				
491 GT 50	97->	033584	722,-	903,-
491 Sport 50	97->	033584	722,-	903,-
K2/LC 50	96->	033584	722,-	903,-

BETA				
Ark AC/LC 50	96->	033584	722,-	903,-

CPI				
Aragon 50 (Euro 2)	Alle	033585	709,-	886,-
Formula R 50	Alle	033585	709,-	886,-
GTR 50	Alle	033585	709,-	886,-
Hussar 50	Alle	033585	709,-	886,-
Oliver/City 50	Alle	033585	709,-	886,-
Popcorn 50	Alle	033585	709,-	886,-

DERBI				
Atlantis 50	Alle	033581	722,-	903,-
Atlantis (Piaggio) 50	Alle	033582	722,-	903,-
GP1 (Piaggio) 50	Alle	033582	722,-	903,-
Hunter 50	Alle	033581	722,-	903,-
Manhattan 50	Alle	033581	722,-	903,-
MotoGP (GP1) 50	Alle	033581	722,-	903,-
Paddock AC 50	Alle	033581	722,-	903,-
Predator LC 50	Alle	033581	722,-	903,-
Vamos (Morini) 50	Alle	033581	722,-	903,-

FALCON				
Big Wheel 50	Alle	033584	722,-	903,-
Star-50	Alle	033584	722,-	903,-

FYM				
QT 50 (4 t.)*	Alle	033586	313,-	391,-

GENERIC				
Ideo 50	Alle	033585	709,-	886,-
Race 50	Alle	033585	709,-	886,-
Xor 50	Alle	033585	709,-	886,-

GIANTCO				
G-Buddy 50 (4 t.)*	Alle	033586	313,-	391,-
Sprint 50 (4 t.)*	Alle	033586	313,-	391,-
Stealth 50 (4 t.)*	Alle	033586	313,-	391,-

MÆRKE/MODEL	ÅRG.	Varenr.		
MÆRKE/MODELL	ÅRG.	Art.NR.	DKK	SEK
GIANTCO				
Venus 50* (4 t.)	Alle	033586	313,-	391,-

GILERA				
DNA LC 50	Alle	033582	722,-	903,-
ICE AC 50	Alle	033582	722,-	903,-
Runner AC 50	Alle	033582	722,-	903,-
Runner LC 50	Alle	033582	722,-	903,-
Runner PJ 50	03->	033582	722,-	903,-
Runner SP LC 50	02->	033582	722,-	903,-
Stalker 50	Alle	033582	722,-	903,-
Typhoon 50	->01	033582	722,-	903,-
Typhoon-X 50	02->	033582	722,-	903,-

HOOPER				
One 50 (4 t.)*	Alle	033586	313,-	391,-

HONDA				
SFX 50	Alle	033582	722,-	903,-
Sky 50	Alle	033582	722,-	903,-
Vision Met In 50	Alle	033582	722,-	903,-
Vision SA 50	Alle	033582	722,-	903,-
X8-R 50	Alle	033582	722,-	903,-

HYOSUNG				
SB 50 M (Cab)	Alle	033581	722,-	903,-
SF 50 B (Racing)	Alle	033581	722,-	903,-
SF 50 R (Rally)	Alle	033581	722,-	903,-

ITALJET				
Formula 50	Alle	033581	722,-	903,-
Velocifero 50	Alle	033581	722,-	903,-

KEEWAY				
F-act 50	Alle	033585	709,-	886,-
Flash 50	Alle	033585	709,-	886,-
Focus 50	Alle	033585	709,-	886,-
Matrix 50	Alle	033585	709,-	886,-

KYMCO				
Agility 50 (4 t.)*	Alle	033586	313,-	391,-
K-12 50	Alle	033580	722,-	903,-
NZ-50 Super Fever	03->	033580	722,-	903,-
Super 8 50 (4 t.)*	Alle	033586	313,-	391,-

MALAGUTI				
F10 AC 50	Alle	033584	722,-	903,-
F12 Phantom AC 50	Alle	033584	722,-	903,-
F15 Firefox LC 50	Alle	033584	722,-	903,-

PEUGEOT				
Buxy 50	94->	033582	722,-	903,-
Elyseo 50	98->	033582	722,-	903,-
Elystar 50	Alle	033582	722,-	903,-
Fox 50	Alle	033582	722,-	903,-
Looxor 50	Alle	033582	722,-	903,-
Ludix 50 One	Alle	033582	722,-	903,-
Speedake 50	95->	033582	722,-	903,-
Speedfight -2 AC 50	Alle	033582	722,-	903,-
Speedfight AC 50	95->	033582	722,-	903,-
Speedfight LC 50	Alle	033582	722,-	903,-
Squab 50	95->	033582	722,-	903,-
TKR 50	Alle	033582	722,-	903,-
Trekker 50	98->	033582	722,-	903,-
Trekker/Metal X 50	03->	033582	722,-	903,-
V-Clic 50 (4 t.)*	Alle	033586	313,-	391,-
Vivacity 50	Alle	033582	722,-	903,-
Zenith 50	94->	033582	722,-	903,-

PEXMA				
KD 50 (4 t.)*	Alle	033586	313,-	391,-

PGO				
Big Max 50	Alle	033583	722,-	903,-
Black Magic 50	Alle	033583	722,-	903,-
Bubu 50	Alle	033583	722,-	903,-
Comet 50	Alle	033583	722,-	903,-
Dr. Big 50	Alle	033583	722,-	903,-
Galaxy 50	Alle	033583	722,-	903,-
G-Max 50	Alle	033583	722,-	903,-
Hot-50	Alle	033583	722,-	903,-
Ligero 50	Alle	033583	722,-	903,-
PMS 50	Alle	033583	722,-	903,-
PMX 50	Alle	033583	722,-	903,-

REMSKIVE KOMPLET MED KOBLING
REMSKIVA KOMPLETT MED KOPPLING



MÆRKE/MODEL	ÅRG.	Varenr.		
MÄRKE/MODELL	ÅRG.	Art.NR.	DKK	SEK
PGO				
Rodoshow 50	Alle	033583	722,-	903:-
Streetfighter 50	Alle	033583	722,-	903:-
T-Rex 50	Alle	033583	722,-	903:-
Tornado 50	Alle	033583	722,-	903:-

PIAGGIO/VESPA

ET2 50	97->	033582	722,-	903:-
NRG Extreme MC3 AC 50	Alle	033582	722,-	903:-
NRG Extreme MC3 LC 50	Alle	033582	722,-	903:-
NRG MC-2 LC 50	94->	033582	722,-	903:-
Typhoon 50	Alle	033582	722,-	903:-
Typhoon-X 50	Alle	033582	722,-	903:-
Zip 2000 50	00->	033582	722,-	903:-
Zip 50	93->	033582	722,-	903:-
Zip 50 (4 t.)	00->	033582	722,-	903:-

SANELI

Bahne (4 t.)*	Alle	033586	313,-	391:-
---------------	------	--------	-------	-------

STRANGER

X-fight 50 (4 t.)*	Alle	033586	313,-	391:-
--------------------	------	--------	-------	-------

SUZUKI

Adress AP-50	Alle	033581	722,-	903:-
--------------	------	--------	-------	-------

TEXAS

Chili 50 (4 t.)*	Alle	033586	313,-	391:-
------------------	------	--------	-------	-------

City 50 (4 t.)*	Alle	033586	313,-	391:-
-----------------	------	--------	-------	-------

Flash 50 (4 t.)*	Alle	033586	313,-	391:-
------------------	------	--------	-------	-------

Free 50 (4 t.)*	Alle	033586	313,-	391:-
-----------------	------	--------	-------	-------

TGB/TOBI

303/309 50	Alle	033581	722,-	903:-
------------	------	--------	-------	-------

Akros 50	Alle	033581	722,-	903:-
----------	------	--------	-------	-------

TMS

Retro (4 t.)*	Alle	033586	313,-	391:-
---------------	------	--------	-------	-------

S3 50 (4 t.)*	Alle	033586	313,-	391:-
---------------	------	--------	-------	-------

Z2 50 (4 t.)*	Alle	033586	313,-	391:-
---------------	------	--------	-------	-------

TOBILINER

QT 50 (4 t.)*	Alle	033586	313,-	391:-
---------------	------	--------	-------	-------

YAMAHA

Aerox 50	97->	033584	722,-	903:-
----------	------	--------	-------	-------

Axis 50	95->	033584	722,-	903:-
---------	------	--------	-------	-------

Bump 50	97->	033584	722,-	903:-
---------	------	--------	-------	-------

BW's 50	Alle	033584	722,-	903:-
---------	------	--------	-------	-------

BW's N.G. 50	Alle	033584	722,-	903:-
--------------	------	--------	-------	-------

Jog Artistic - Fine Selection 50	Alle	033584	722,-	903:-
----------------------------------	------	--------	-------	-------

Jog Space Innovacion 50	98->	033584	722,-	903:-
-------------------------	------	--------	-------	-------

Jog-R 50	03->	033584	722,-	903:-
----------	------	--------	-------	-------

Jog-RR 50	03->	033584	722,-	903:-
-----------	------	--------	-------	-------

Neo's 50	97->	033584	722,-	903:-
----------	------	--------	-------	-------

Slider 50	01->	033584	722,-	903:-
-----------	------	--------	-------	-------

Spy 50	Alle	033584	722,-	903:-
--------	------	--------	-------	-------

Why 50	99->	033584	722,-	903:-
--------	------	--------	-------	-------

YIYING

Stranger 50 (4 t.)*	Alle	033586	313,-	391:-
---------------------	------	--------	-------	-------

* Komplet med koblingskål!
 * Komplet med lamellkorg!



A-mål= Diameter på koblingen

B-mål= Diameter på skiven



033580
A-mål: 107 mm. - B-mål: 115 mm.



033583
A-mål: 107 mm. - B-mål: 118 mm.



033581
A-mål: 107 mm. - B-mål: 123 mm.

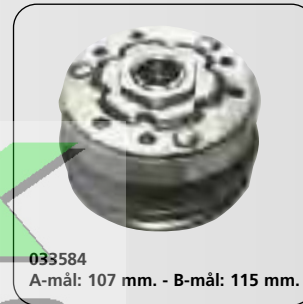

033584
A-mål: 107 mm. - B-mål: 115 mm.



033582
A-mål: 107 mm. - B-mål: 118 mm.



033585
A-mål: 112 mm. - B-mål: 115 mm.



Med koblingskål
033586
A-mål: 107 mm. - B-mål: 118 mm.

Forhandlere
Återförsäljare
s. 2

Stökd
Sökd
s. 4

Tøj/hjelme
Klæder/
hjelmar
s. 6

Dæk og
slanger
Dæk och
slangar
s. 15

Olje / spray
Olja / spray
s. 26

Kæder /
tandhjul
Kedjor /
drev
s. 43

Bremse
delar
Bromsdelar
s. 48

Låse
Lås
s. 93

Batteri
Batteri
s. 96

Cylinder /
topstycke
Cylinder /
topplock
s. 105

Motordele
Motordele
s. 137

Karburator
- Luftfilter
Förgasare
- Luftfilter
s. 208

El-dele
tændrør
Elektriskt
tändstift
s. 222

Udstødning
Avgassystem
s. 246

Forgaffel
Støddæmpere
Framgaffel
Støtdämpare
s. 260

Kabler
Wire
s. 266

Styr og
greb
Styre och
handtag
s. 272

Spejle
Speglar
s. 282

Blinklygter
Baglygter
Blinkers
Baklykte
s. 284

Støtteben
Toppoks, mm.
Stödd
Toppox, mm
s. 291

Rep. bøger
værktøj
Rep. böcker
Verktyg
s. 297

MÆRKE/MODEL	ÅRG.	Varenr.	MÅL		
MARKE/MODELL	ÅRG.	Art.NR.	Mått	DKK	SEK
ADLY					
Cat 50	Alle	033559	115 mm/Ø34	533,-	666,-
Jet 50	Alle	033559	115 mm/Ø34	533,-	666,-
Silver Fox 50	Alle	033559	115 mm/Ø34	533,-	666,-
Super Sonic 50	Alle	033559	115 mm/Ø34	533,-	666,-
Thunder Bike 50	Alle	033559	115 mm/Ø34	533,-	666,-
APRILIA					
Amico 50	96->	033559	115 mm/Ø34	533,-	666,-
Area 51 LC 50	98->	033559	115 mm/Ø34	533,-	666,-
Gulliver 50	96->	033559	115 mm/Ø34	533,-	666,-
Habana AC (Morini) 50	Alle	033547	123 mm/Ø34	533,-	666,-
Rally AC 50	96->	033559	115 mm/Ø34	533,-	666,-
Scarabeo 50	96->	033559	115 mm/Ø34	533,-	666,-
Scarabeo Ditech (Morini) 50	02->	033547	123 mm/Ø34	533,-	666,-
Sonic AC 50	Alle	033559	115 mm/Ø34	533,-	666,-
Sonic LC 50	Alle	033559	115 mm/Ø34	533,-	666,-
SR - Ditech (Morini) 50	Alle	033547	123 mm/Ø34	533,-	666,-
SR - www AC 50	97->	033559	115 mm/Ø34	533,-	666,-
SR-50 AC/LC	96->	033559	115 mm/Ø34	533,-	666,-
SR-Racing 50, Stealth, Netscaper LC	Alle	033559	115 mm/Ø34	533,-	666,-
SR-Replica LC (Minarelli) 50	->00	033559	115 mm/Ø34	533,-	666,-
SR-Replica-2000 LC (Morini) 50	00->	033547	123 mm/Ø34	533,-	666,-
ATALA					
Carosello 50	96->	033559	115 mm/Ø34	533,-	666,-
Hacker AT-12 50	Alle	033547	123 mm/Ø34	533,-	666,-
Hacker LC 50	Alle	033547	123 mm/Ø34	533,-	666,-
Skeggia 50	Alle	033547	123 mm/Ø34	533,-	666,-
BENELLI					
491 GT 50	97->	033559	115 mm/Ø34	533,-	666,-
491 Sport 50	97->	033559	115 mm/Ø34	533,-	666,-
K2/LC 50	96->	033559	115 mm/Ø34	533,-	666,-
BETA					
Ark AC/LC 50	96->	033559	115 mm/Ø34	533,-	666,-
CPI					
Aragon 50 (Euro 2)	Alle	033559	115 mm/Ø34	533,-	666,-
Formula R 50 (Euro 2)	Alle	033559	115 mm/Ø34	533,-	666,-
Hussar 50	Alle	033559	115 mm/Ø34	533,-	666,-
Oliver/City 50 (Euro 2)	Alle	033559	115 mm/Ø34	533,-	666,-
Popcorn 50	Alle	033559	115 mm/Ø34	533,-	666,-
DERBI					
Atlantis 50	Alle	033547	123 mm/Ø34	533,-	666,-
Atlantis 50	Alle	033557	127 mm/Ø34	533,-	666,-
GP1 (Piaggio) 50	Alle	033557	127 mm/Ø34	533,-	666,-
Hunter 50	Alle	033547	123 mm/Ø34	533,-	666,-
Manhattan 50	Alle	033547	123 mm/Ø34	533,-	666,-
MotoGP (GP1) 50	Alle	033547	123 mm/Ø34	533,-	666,-
Paddock AC 50	Alle	033547	123 mm/Ø34	533,-	666,-
Predator LC 50	Alle	033547	123 mm/Ø34	533,-	666,-
Vamos (Morini) 50	Alle	033547	123 mm/Ø34	533,-	666,-
FALCON					
Big Wheel 50	Alle	033559	115 mm/Ø34	533,-	666,-
Star-50	Alle	033559	115 mm/Ø34	533,-	666,-
GILERA					
DNA LC 50	Alle	033555	134 mm/Ø34	533,-	666,-
DNA LC 50	Alle	033557	127 mm/Ø34	533,-	666,-
ICE AC 50	Alle	033555	134 mm/Ø34	533,-	666,-
ICE AC 50	Alle	033557	127 mm/Ø34	533,-	666,-
Runner LC 50	Alle	033555	134 mm/Ø34	533,-	666,-
Runner LC 50	Alle	033557	127 mm/Ø34	533,-	666,-
Runner PJ 50	03->	033555	134 mm/Ø34	533,-	666,-
Runner PJ 50	03->	033557	127 mm/Ø34	533,-	666,-
Runner SP LC 50	02->	033555	134 mm/Ø34	533,-	666,-
Runner SP LC 50	02->	033557	127 mm/Ø34	533,-	666,-
Stalker 50	Alle	033555	134 mm/Ø34	533,-	666,-
Stalker 50	Alle	033557	127 mm/Ø34	533,-	666,-
Typhoon 50	->01	033555	134 mm/Ø34	533,-	666,-
Typhoon 50	->01	033557	127 mm/Ø34	533,-	666,-
Typhoon-X 50	02->	033555	134 mm/Ø34	533,-	666,-
Typhoon-X 50	02->	033557	127 mm/Ø34	533,-	666,-
HONDA					
SFX 50	Alle	033557	127 mm/Ø34	533,-	666,-
Sky 50	Alle	033557	127 mm/Ø34	533,-	666,-
Vision Met In 50	Alle	033557	127 mm/Ø34	533,-	666,-
Vision SA 50	Alle	033557	127 mm/Ø34	533,-	666,-
Wallaroo 50	Alle	033557	127 mm/Ø34	533,-	666,-
X8-R 50	Alle	033557	127 mm/Ø34	533,-	666,-
ITALJET					
Formula 50	Alle	033547	123 mm/Ø34	533,-	666,-
Velocifero 50	Alle	033547	123 mm/Ø34	533,-	666,-

DKK Kontroller at diameteren på remskiven svarer til typegodkendelsen, og evt. Dit komponentmærkningsskilt, hvorpå der muligvis er anført diameter størrelse. Kontroller samtidig at remskive, yderst og inderst, passer i diameteren sammen.

SEK Kontrollera att diametern på remskivan motsvarar ditt typgodkännande och att remskivans invändiga och utvändiga diameter stämmer överens.



M/ÆRKE/MODEL	ÅRG.	Varenr.	MÅL		
MÄRKE/MODELL	ÅRG.	Art.NR.	Mått	DKK	SEK
KEEWAY					
F-act 50	Alle	033559	115 mm/Ø34	533,-	666,-
Flash 50	Alle	033559	115 mm/Ø34	533,-	666,-
Focus 50	Alle	033559	115 mm/Ø34	533,-	666,-
Matrix 50	Alle	033559	115 mm/Ø34	533,-	666,-
KYMCO					
K-12 50	Alle	033557	127 mm/Ø34	533,-	666,-
NZ-50 Super Fever	03->	033557	127 mm/Ø34	533,-	666,-
People 50	Alle				
MALAGUTI					
F10 AC 50	Alle	033559	115 mm/Ø34	533,-	666,-
F12 Phantom AC 50	Alle	033559	115 mm/Ø34	533,-	666,-
F15 Firefox LC 50	Alle	033559	115 mm/Ø34	533,-	666,-
PEUGEOT					
Buxy 50	94->	033557	127 mm/Ø34	533,-	666,-
Elyseo 50	98->	033557	127 mm/Ø34	533,-	666,-
Elystar 50	Alle	033557	127 mm/Ø34	533,-	666,-
Fox 50	Alle	033557	127 mm/Ø34	533,-	666,-
Speedake 50	95->	033557	127 mm/Ø34	533,-	666,-
Speedfight -2 AC 50	Alle	033557	127 mm/Ø34	533,-	666,-
Speedfight AC 50	95->	033557	127 mm/Ø34	533,-	666,-
Speedfight LC 50	Alle	033557	127 mm/Ø34	533,-	666,-
Squab 50	95->	033557	127 mm/Ø34	533,-	666,-
Trekker 50	98->	033557	127 mm/Ø34	533,-	666,-
Trekker/Metal X 50	03->	033557	127 mm/Ø34	533,-	666,-
Vivacity 50	Alle	033557	127 mm/Ø34	533,-	666,-
Zenith 50	94->	033557	127 mm/Ø34	533,-	666,-
PGO					
Big Max 50	Alle	033559	118 mm/Ø34	533,-	666,-
Black Magic 50	Alle	033559	118 mm/Ø34	533,-	666,-
Bubu 50	Alle	033559	118 mm/Ø34	533,-	666,-
Comet 50	Alle	033559	118 mm/Ø34	533,-	666,-
Dr. Big 50	Alle	033559	118 mm/Ø34	533,-	666,-
Galaxy 50	Alle	033559	118 mm/Ø34	533,-	666,-
Hot-50	Alle	033559	118 mm/Ø34	533,-	666,-
Ligero 50	Alle	033559	118 mm/Ø34	533,-	666,-
PMS 50	Alle	033559	118 mm/Ø34	533,-	666,-
PMX 50	Alle	033559	118 mm/Ø34	533,-	666,-
Rodoshow 50	Alle	033559	118 mm/Ø34	533,-	666,-
T-Rex 50	Alle	033559	118 mm/Ø34	533,-	666,-
Tornado 50	Alle	033559	118 mm/Ø34	533,-	666,-
PIAGGIO/VESPA					
ET2 50	97->	033555	134 mm/Ø34	533,-	666,-
ET2 50	97->	033557	127 mm/Ø34	533,-	666,-
NRG Extreme MC3 AC 50	03->	033555	134 mm/Ø34	533,-	666,-
NRG Extreme MC3 AC 50	03->	033557	127 mm/Ø34	533,-	666,-
NRG Extreme MC3 LC 50	01->	033555	134 mm/Ø34	533,-	666,-
NRG Extreme MC3 LC 50	01->	033557	127 mm/Ø34	533,-	666,-
NRG MC-2 LC 50	94->	033555	134 mm/Ø34	533,-	666,-
NRG MC-2 LC 50	94->	033557	127 mm/Ø34	533,-	666,-
Zip 2000 50	00->	033555	134 mm/Ø34	533,-	666,-
Zip 2000 50	00->	033557	127 mm/Ø34	533,-	666,-
Zip 50	93->	033555	134 mm/Ø34	533,-	666,-
Zip 50	93->	033557	127 mm/Ø34	533,-	666,-
SUZUKI					
Adress AP-50	Alle	033547	123 mm/Ø34	533,-	666,-
Adress AP-50	Alle	033546	130 mm/Ø34	533,-	666,-
Katana AY-50 AC	->99	033547	123 mm/Ø34	533,-	666,-
Katana AY-50 AC/LC	00->	033557	127 mm/Ø34	533,-	666,-
Katana AY-50 AC/LC	00->	033546	130 mm/Ø34	533,-	666,-
Zillion LC, UX-50	Alle	033557	127 mm/Ø34	533,-	666,-
TGB/TOBI					
303/309 50	Alle	033547	123 mm/Ø34	533,-	666,-
Akros 50	Alle	033547	123 mm/Ø34	533,-	666,-
YAMAHA					
Aerox 50	97->	033559	115 mm/Ø34	533,-	666,-
Aerox-R 50	03->	033559	115 mm/Ø34	533,-	666,-
Axis 50	95->	033559	115 mm/Ø34	533,-	666,-
Bump 50	97->	033559	115 mm/Ø34	533,-	666,-
BW's 50	96->	033559	115 mm/Ø34	533,-	666,-
BW's N.G. 50	96->	033559	115 mm/Ø34	533,-	666,-
Jog Artistic -Fine Selection 50	96->	033559	115 mm/Ø34	533,-	666,-
Jog Space Innovation 50	98->	033559	115 mm/Ø34	533,-	666,-
Jog-R 50	03	033559	115 mm/Ø34	533,-	666,-
Jog-RR 50	03	033559	115 mm/Ø34	533,-	666,-
Neo's 50	97->	033559	115 mm/Ø34	533,-	666,-
Slider 50	01->	033559	115 mm/Ø34	533,-	666,-
Spy 50	Alle	033559	115 mm/Ø34	533,-	666,-
Why 50	99->	033559	115 mm/Ø34	533,-	666,-



MÆRKE/MODEL	ÅRG.	Varenr.	MÅL		
MÄRKE/MODELL	ÅRG.	Art.NR.	Mått	DKK	SEK
ADLY					
Cat 50	Alle	033558	115 mm/ø34	265,-	331:-
Jet 50	Alle	033558	115 mm/ø34	265,-	331:-
Silver Fox 50	Alle	033558	115 mm/ø34	265,-	331:-
Super Sonic 50	Alle	033558	115 mm/ø34	265,-	331:-
Thunder Bike 50	Alle	033558	115 mm/ø34	265,-	331:-
APRILIA					
Amico 50	96->	033558	115 mm/ø34	265,-	331:-
Area 51 LC 50	98->	033558	115 mm/ø34	265,-	331:-
Gulliver 50	96->	033558	115 mm/ø34	265,-	331:-
Habana AC (Morini) 50	Alle	033549	123 mm/ø34	265,-	331:-
Rally AC 50	96->	033558	115 mm/ø34	265,-	331:-
Scarabeo 50	96->	033558	115 mm/ø34	265,-	331:-
Scarabeo Ditech (Morini) 50	02->	033549	123 mm/ø34	265,-	331:-
Sonic AC 50	Alle	033558	115 mm/ø34	265,-	331:-
Sonic LC 50	Alle	033558	115 mm/ø34	265,-	331:-
SR - Ditech (Morini) 50	Alle	033549	123 mm/ø34	265,-	331:-
SR - www AC 50	97->	033558	115 mm/ø34	265,-	331:-
SR-50 AC/LC	96->	033558	115 mm/ø34	265,-	331:-
SR-Racing 50, Stealth, Netscaper LC	Alle	033558	115 mm/ø34	265,-	331:-
SR-Replica LC (Minarelli) 50	->00	033558	115 mm/ø34	265,-	331:-
SR-Replica-2000 LC (Morini) 50	00->	033549	123 mm/ø34	265,-	331:-
ATALA					
Carosello 50	96->	033558	115 mm/ø34	265,-	331:-
Hacker AT-12 50	Alle	033549	123 mm/ø34	265,-	331:-
Hacker LC 50	Alle	033549	123 mm/ø34	265,-	331:-
Skeggia 50	Alle	033549	123 mm/ø34	265,-	331:-
BENELLI					
491 GT 50	97->	033558	115 mm/ø34	265,-	331:-
491 Sport 50	97->	033558	115 mm/ø34	265,-	331:-
K2/LC 50	96->	033558	115 mm/ø34	265,-	331:-
BETA					
Ark AC/LC 50	96->	033558	115 mm/ø34	265,-	331:-
CPI					
Aragon 50 (Euro 2)	Alle	033558	115 mm/ø34	265,-	331:-
Formula R 50 (Euro 2)	Alle	033558	115 mm/ø34	265,-	331:-
Hussar 50	Alle	033558	115 mm/ø34	265,-	331:-
Oliver/City 50 (Euro 2)	03->	033558	115 mm/ø34	265,-	331:-
Popcorn 50	Alle	033558	115 mm/ø34	265,-	331:-
DERBI					
Atlantis 50		033549	123 mm/ø34	265,-	331:-
Atlantis 50 (Piaggio)		033556	127 mm/ø34	265,-	331:-
GP1 50		033556	127 mm/ø34	265,-	331:-
Hunter 50		033549	123 mm/ø34	265,-	331:-
Manhattan 50		033549	123 mm/ø34	265,-	331:-
MotoGP (GP1) 50		033549	123 mm/ø34	265,-	331:-
Paddock AC 50		033549	123 mm/ø34	265,-	331:-
Predator LC 50		033549	123 mm/ø34	265,-	331:-
Vamos (Morini) 50	Alle	033549	123 mm/ø34	265,-	331:-
FALCON					
Big Wheel 50	Alle	033558	115 mm/ø34	265,-	331:-
Star-50	Alle	033558	115 mm/ø34	265,-	331:-
GENERIC					
Ideo 50	Alle	033548	115 mm/ø34	260,-	325:-
Xor 50	Alle	033548	115 mm/ø34	260,-	325:-
GILERA					
DNA LC 50	Alle	033556	127 mm/ø34	265,-	331:-
ICE AC 50	Alle	033556	127 mm/ø34	265,-	331:-
Runner LC 50	Alle	033556	127 mm/ø34	265,-	331:-
Runner PJ 50	03->	033556	127 mm/ø34	265,-	331:-
Runner SP LC 50	02->	033556	127 mm/ø34	265,-	331:-
Stalker 50	Alle	033554	134 mm/ø34	265,-	331:-
Typhoon 50	->01	033554	134 mm/ø34	265,-	331:-
Typhoon 50	02->	033556	127 mm/ø34	265,-	331:-
Typhoon-X 50	->01	033554	134 mm/ø34	265,-	331:-
Typhoon-X 50	02->	033556	127 mm/ø34	265,-	331:-

Yderste koblingsremskive.
Kontroller at diameteren på remskiven svarer til typegodkendelsen, kontroller evt. dit komponentmærkningskilt, hvorpå der muligvis er anført størrelse.

Yttre kopplingsremskiva.
Kontroller at diameteren på remskivan stammer mot typgodkännandet.
Kontrollera ev. komponentnummer då denna kan ange annan storlek.



Møtrik for kobling

Motor kit för koppling

Gilera / Piaggio 38x1 mm **DKK** **SEK**
Varenr. 033560 16,- 20:-

Gilera / Piaggio 36x1 mm
Varenr. 033561 16,- 20:-

Gilera / Piaggio 28x1 mm
Varenr. 033562 16,- 20:-

Aprilia / Yamaha / Minarelli 28x1 mm
Varenr. 033562 16,- 20:-

Nåleleje for remskive

Nållager för remskiva

Aprilia / Yamaha / MBK / Minarelli / Piaggio

MÅL	VARENDR.	DKK	SEK
Ø17x25x18 mm.	033563	79,-	99:-

Leje for remskive

Lager för remskiva

Aprilia / Yamaha / MBK / Minarelli / Piaggio

MÅL	VARENDR.	DKK	SEK
Ø12x24x6 mm.	033564	79,-	99:-

Fjederstyr

Fjäderstyrning

CPI / Generic / Giantco / Keeway. Længde 29 mm.

MÅL	VARENDR.	DKK	SEK
Ø (indv.) 43,5 mm.	033565	41,-	51:-

Styrestift for koblingsnav

Styrnings stift för kopplings nav

CPI / Generic / Giantco / Keeway.

MÅL	VARENDR.	DKK	SEK
9,5x5x6 mm.	033566	11,-	14:-

Møtrik for koblingsskål

Motor kit för kopplings korg

CPI / Generic / Giantco / Keeway.

MÅL	VARENDR.	DKK	SEK
	033567	20,-	25:-

MÆRKE/MODEL	ÅRG.	Varenr.	MÅL		
MÄRKE/MODELL	ÅRG.	Art.NR.	Mått	DKK	SEK
HONDA					
SFX 50	Alle	033556	127 mm/ø34	265,-	331,-
Sky 50	Alle	033556	127 mm/ø34	265,-	331,-
Vision Met In 50	Alle	033556	127 mm/ø34	265,-	331,-
Vision SA 50	Alle	033556	127 mm/ø34	265,-	331,-
Wallaroo 50	Alle	033556	127 mm/ø34	265,-	331,-
X8-R 50	Alle	033556	127 mm/ø34	265,-	331,-

HYOSUNG					
SB 50 M (Cab)	Alle	033549	123 mm/ø34	265,-	331,-
SF 50 B (Racing)	Alle	033549	123 mm/ø34	265,-	331,-
SF 50 R (Rally)	Alle	033549	123 mm/ø34	265,-	331,-

ITALJET					
Formula 50	Alle	033549	123 mm/ø34	265,-	331,-
Velocifero 50	Alle	033549	123 mm/ø34	265,-	331,-

KEEWAY					
F-act 50	Alle	033558	115 mm/ø34	265,-	331,-
Flash 50	Alle	033558	115 mm/ø34	265,-	331,-
Focus 50	Alle	033558	115 mm/ø34	265,-	331,-
Matrix 50	Alle	033558	115 mm/ø34	265,-	331,-

KYMCO					
K-12 50	Alle	033556	127 mm/ø34	265,-	331,-
NZ-50 Super Fever	03->	033556	127 mm/ø34	265,-	331,-

MALAGUTI					
F10 AC 50	Alle	033558	115 mm/ø34	265,-	331,-
F12 Phantom AC 50	Alle	033558	115 mm/ø34	265,-	331,-
F15 Firefox LC 50	Alle	033558	115 mm/ø34	265,-	331,-

PEUGEOT					
Buxy 50	94->	033556	127 mm/ø34	265,-	331,-
Elyseo 50	98->	033556	127 mm/ø34	265,-	331,-
Élystar 50	Alle	033556	127 mm/ø34	265,-	331,-
Fox 50	Alle	033556	127 mm/ø34	265,-	331,-
Looxor 50	Alle	033556	127 mm/ø34	265,-	331,-
Ludix 50 One	Alle	033556	127 mm/ø34	265,-	331,-
Speedake 50	95->	033556	127 mm/ø34	265,-	331,-
Speedfight -2 AC 50	Alle	033556	127 mm/ø34	265,-	331,-
Speedfight AC 50	Alle	033556	127 mm/ø34	265,-	331,-
Speedfight LC 50	Alle	033556	127 mm/ø34	265,-	331,-
Squab 50	95->	033556	127 mm/ø34	265,-	331,-
TKR 50	Alle	033556	127 mm/ø34	265,-	331,-
Trekker 50	98->	033556	127 mm/ø34	265,-	331,-
Trekker/Metal X 50	03->	033556	127 mm/ø34	265,-	331,-
Vivacity 50	Alle	033556	127 mm/ø34	265,-	331,-
Zenith 50	94->	033556	127 mm/ø34	265,-	331,-

PGO					
Big Max 50	Alle	033558	115 mm/ø34	265,-	331,-
Black Magic 50	Alle	033558	115 mm/ø34	265,-	331,-
Bubu 50	Alle	033558	115 mm/ø34	265,-	331,-
Comet 50	Alle	033558	115 mm/ø34	265,-	331,-
Dr. Big 50	Alle	033558	115 mm/ø34	265,-	331,-
Galaxy 50	Alle	033558	115 mm/ø34	265,-	331,-
G-Max 50	Alle	033558	115 mm/ø34	265,-	331,-
Hot-50	Alle	033558	115 mm/ø34	265,-	331,-
Ligero 50	Alle	033558	115 mm/ø34	265,-	331,-
PMS 50	Alle	033558	115 mm/ø34	265,-	331,-
PMX 50	Alle	033558	115 mm/ø34	265,-	331,-
Rodoshow 50	Alle	033558	115 mm/ø34	265,-	331,-
Streetfighter 50	Alle	033558	115 mm/ø34	265,-	331,-
T-Rex 50	Alle	033558	115 mm/ø34	265,-	331,-
Tornado 50	Alle	033558	115 mm/ø34	265,-	331,-

PIAGGIO/VESPA					
ET2 50	97->	033554	134 mm/ø34	265,-	331,-
ET2 50	97->	033556	127 mm/ø34	265,-	331,-
NRG Extreme MC3 AC 50	Alle	033554	134 mm/ø34	265,-	331,-
NRG Extreme MC3 LC 50	Alle	033556	127 mm/ø34	265,-	331,-
NRG MC-2 LC 50	94->	033554	134 mm/ø34	265,-	331,-
NRG MC-2 LC 50	94->	033556	127 mm/ø34	265,-	331,-
Zip 2000 50	00->	033554	134 mm/ø34	265,-	331,-
Zip 2000 50	00->	033556	127 mm/ø34	265,-	331,-
Zip 50	93->	033554	134 mm/ø34	265,-	331,-
Zip 50	93->	033556	127 mm/ø34	265,-	331,-
Zip 50 - 4-Takt	00->	033554	134 mm/ø34	265,-	331,-
Zip 50 - 4-Takt	00->	033556	127 mm/ø34	265,-	331,-

MÆRKE/MODEL	ÅRG.	Varenr.	MÅL		
MÄRKE/MODELL	ÅRG.	Art.NR.	Mått	DKK	SEK
SUZUKI					
Adress AP-50	Alle	033549	123 mm/ø34	265,-	331,-
Adress AP-50	Alle	033545	130 mm/ø34	265,-	331,-
Katana AY-50 AC	->99	033549	123 mm/ø34	265,-	331,-
Katana AY-50 AC/LC	00->	033556	127 mm/ø34	265,-	331,-
Katana AY-50 AC/LC	00->	033545	130 mm/ø34	265,-	331,-
Zillion LC, UX-50	Alle	033556	127 mm/ø34	265,-	331,-

TGB/TOBI					
303/309 50	Alle	033549	123 mm/ø34	265,-	331,-
Akros 50	Alle	033549	123 mm/ø34	265,-	331,-

YAMAHA					
Aerox 50	97->	033558	115 mm/ø34	265,-	331,-
Aerox-R 50	03->	033558	115 mm/ø34	265,-	331,-
Axis 50	95->	033558	115 mm/ø34	265,-	331,-
Bump 50	97->	033558	115 mm/ø34	265,-	331,-
BW's 50	96->	033558	115 mm/ø34	265,-	331,-
BW's N.G. 50	96->	033558	115 mm/ø34	265,-	331,-
Jog Artistic - Fine Selection 50	96->	033558	115 mm/ø34	265,-	331,-
Jog Space Innovation 50	98->	033558	115 mm/ø34	265,-	331,-
Jog-R 50	03->	033558	115 mm/ø34	265,-	331,-
Jog-RR 50	03->	033558	115 mm/ø34	265,-	331,-
Neo's 50	97->	033558	115 mm/ø34	265,-	331,-
Slider 50	01->	033558	115 mm/ø34	265,-	331,-
Spy 50	Alle	033558	115 mm/ø34	265,-	331,-
Why 50	99->	033558	115 mm/ø34	265,-	331,-

DKK Koblingstrykfjeder
SEK Tryckfjäder koppling



Leveres i sæt med 3 forskellige hårdheder:
Grøn 15% Rød 22% Blå 30%

VARENr.	SPEC.	MÅL	DKK	SEK
033575	3 stk=sæt		143,-	179,-
033576	3 stk=sæt	102*ø50,25/ø57 mm	143,-	179,-



DKK Centerkoblingsfjeder
SEK Centrums kopplingsfjäder

Leveres i sæt med 3 forskellige hårdheder:
Grøn 15% Rød 30% Blå 50%

VARENr.	SPEC.	MÅL	DKK	SEK
033601	2 sæt	33*Ø10 mm	79,-	99,-
033602	3 sæt	34*Ø8 mm	79,-	99,-

033601



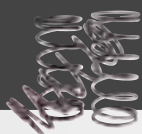

Mærke/model	Årg.	Remskive racing Varenr. Mål		Koblingstrykfjeder Varenr.			Centerkoblingsfjeder Varenr.				
Mærke/modell	Årg.	Remskiva racing Art.nr.	Mått	DKK	SEK	Kopplingstryckfjädrar Art.nr.	DKK	SEK	Centerkopplingsfjädrar Art.nr.	DKK	SEK
ADLY											
Cat 50	Alle	033551	118 mm/ø34	394,-	493,-	033575	143,-	179,-	033602	79,-	99,-
Jet 50	Alle	033551	118 mm/ø34	394,-	493,-	033575	143,-	179,-	033602	79,-	99,-
Silver Fox 50	Alle	033551	118 mm/ø34	394,-	493,-						
Super Sonic 50	Alle	033551	118 mm/ø34	394,-	493,-						
Thunder Bike 50	Alle	033551	118 mm/ø34	394,-	493,-						
APRILIA											
Amico 50	->96	033550	118 mm/ø33	394,-	493,-	033575	143,-	179,-	033601	79,-	99,-
Amico 50	96->	033551	118 mm/ø34	394,-	493,-	033575	143,-	179,-	033602	79,-	99,-
Area 51 LC 50	98->	033551	118 mm/ø34	394,-	493,-	033575	143,-	179,-	033602	79,-	99,-
Gulliver 50	->96	033550	118 mm/ø33	394,-	493,-	033575	143,-	179,-	033601	79,-	99,-
Gulliver 50	96->	033551	118 mm/ø34	394,-	493,-	033575	143,-	179,-	033602	79,-	99,-
Rally AC 50	->96	033550	118 mm/ø33	394,-	493,-	033575	143,-	179,-	033601	79,-	99,-
Rally AC 50	96->	033551	118 mm/ø34	394,-	493,-	033575	143,-	179,-	033602	79,-	99,-
Scarabeo 50	->96	033550	118 mm/ø33	394,-	493,-	033575	143,-	179,-	033601	79,-	99,-
Scarabeo 50	96->	033551	118 mm/ø34	394,-	493,-	033575	143,-	179,-	033602	79,-	99,-
Sonic AC 50	Alle	033551	118 mm/ø34	394,-	493,-	033575	143,-	179,-	033602	79,-	99,-
Sonic LC 50	Alle	033551	118 mm/ø34	394,-	493,-	033575	143,-	179,-	033602	79,-	99,-
SR - www AC 50	97->	033551	118 mm/ø34	394,-	493,-	033575	143,-	179,-	033602	79,-	99,-
SR-50 AC/LC	->96	033550	118 mm/ø33	394,-	493,-	033575	143,-	179,-	033601	79,-	99,-
SR-50 AC/LC	96->	033551	118 mm/ø34	394,-	493,-	033575	143,-	179,-	033602	79,-	99,-
SR-Racing, Stealth, Netscaper LC	Alle	033551	118 mm/ø34	394,-	493,-	033575	143,-	179,-	033602	79,-	99,-
SR-Replica LC (Minarelli) 50	->00	033551	118 mm/ø34	394,-	493,-						
ATALA											
Carosello 50	96->	033551	118 mm/ø34	394,-	493,-	033575	143,-	179,-	033602	79,-	99,-
BENELLI											
491 GT 50	97->	033551	118 mm/ø34	394,-	493,-	033575	143,-	179,-	033602	79,-	99,-
491 Sport 50	97->	033551	118 mm/ø34	394,-	493,-	033575	143,-	179,-	033602	79,-	99,-
K2/LC 50	->96	033550	118 mm/ø33	394,-	493,-	033575	143,-	179,-	033601	79,-	99,-
K2/LC 50	96->	033551	118 mm/ø34	394,-	493,-	033575	143,-	179,-	033602	79,-	99,-
Pepe 50	->96	033550	118 mm/ø33	394,-	493,-	033575	143,-	179,-	033601	79,-	99,-
Pepe 50	96->	033551	118 mm/ø34	394,-	493,-	033575	143,-	179,-	033602	79,-	99,-
BETA											
Ark AC/LC 50	->96	033550	118 mm/ø33	394,-	493,-	033575	143,-	179,-	033601	79,-	99,-
Ark AC/LC 50	96->	033551	118 mm/ø34	394,-	493,-	033575	143,-	179,-	033602	79,-	99,-
Quadro 50		033550	118 mm/ø33	394,-	493,-	033575	143,-	179,-	033601	79,-	99,-
Tempo 50		033550	118 mm/ø33	394,-	493,-	033575	143,-	179,-	033601	79,-	99,-
CAGIVA											
City 50						033576	143,-	179,-	033602	79,-	99,-
FALCON											
Big Wheel 50	Alle	033551	118 mm/ø34	394,-	493,-						
Star-50	Alle	033551	118 mm/ø34	394,-	493,-						
GILERA											
DNA LC 50	Alle	033552	129 mm/ø34	394,-	493,-						
Easy Moving 50		033552	129 mm/ø34	394,-	493,-	033576	143,-	179,-	033602	79,-	99,-
ICE AC 50	Alle	033552	129 mm/ø34	394,-	493,-						
Runner 50 AC	Alle	033552	129 mm/ø34	394,-	493,-	033576	143,-	179,-	033602	79,-	99,-
Runner LC 50	Alle	033552	129 mm/ø34	394,-	493,-	033576	143,-	179,-	033602	79,-	99,-
Runner PJ 50	03->	033552	129 mm/ø34	394,-	493,-	033576	143,-	179,-	033602	79,-	99,-
Runner SP LC 50	02->	033552	129 mm/ø34	394,-	493,-	033576	143,-	179,-	033602	79,-	99,-
Stalker 50	Alle	033552	129 mm/ø34	394,-	493,-	033576	143,-	179,-	033602	79,-	99,-
Typhoon 50	Alle	033552	129 mm/ø34	394,-	493,-						
Typhoon-X 50	02->	033552	129 mm/ø34	394,-	493,-						
HONDA											
SFX 50	Alle	033553	118 mm/ø33	394,-	493,-	033576	143,-	179,-	033602	79,-	99,-
Sky 50	Alle	033553	118 mm/ø33	394,-	493,-						
Vision Met In 50	Alle	033553	118 mm/ø33	394,-	493,-	033576	143,-	179,-			
Vision SA 50	Alle	033553	118 mm/ø33	394,-	493,-	033576	143,-	179,-			
X8-R 50	Alle	033553	118 mm/ø33	394,-	493,-	033602	79,-	99,-			
ITALJET											
Dragtster 50		033551	/ø34	394,-	493,-	033575	143,-	179,-	033602	79,-	99,-
Formula 50						033575	143,-	179,-			
Velocifero 50						033575	143,-	179,-			
KYMCO											
K-12 50	Alle	033553	118 mm/ø33	394,-	493,-						
NZ-50 Super Fever	03->	033553	118 mm/ø33	394,-	493,-						
MALAGUTI											
F10 AC 50	->96	033550	118 mm/ø33	394,-	493,-	033575	143,-	179,-	033601	79,-	99,-
F10 AC 50	96->	033551	118 mm/ø34	394,-	493,-	033575	143,-	179,-	033602	79,-	99,-
F12 Phantom AC 50	->96	033550	118 mm/ø33	394,-	493,-	033575	143,-	179,-	033601	79,-	99,-
F12 Phantom AC 50	96->	033551	118 mm/ø34	394,-	493,-	033575	143,-	179,-	033602	79,-	99,-
F15 Firefox LC 50	Alle	033551	118 mm/ø34	394,-	493,-	033575	143,-	179,-	033602	79,-	99,-

Udført med forskellige stigninger på udfærnsningen, afhængig af individuelle behov.

Kontrollér at diametren på remskiven svarer til typegodkendelsen, kontrollér evt. dit komponentmærkningsskilt, hvorpå der muligvis er anført diameterstørrelse. Kontrollér samtidig at remskive, yderst og inderst, passer i diametren sammen.

Utført med olika stigningar på utfræsningen, anpassas efter olika behov. Kontrollera att diametern på remskivan stämmer mot typgodkännelsen. Kontrollera ev. komponentnummer då denna kan ange annan storlek. Kontrollera samtidigt att yttre och inre remskiva stämmer i diameter.

Racing!

- DKK 6 Spor
- SEK 6 Spår



DKK 394,- SEK 493,-

Fremstillet med forskellig stigning på udfærnsningen, som giver et forøget bundtræk.

Framtagen med olika stigning på utfræsning som ger et större bundstråk.

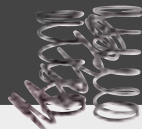

Mærke/model	Årg.	Remskive racing Varenr.	Remskive racing Mål	DKK	SEK	Koblingstrykfjeder Varenr.	DKK	SEK	Centerkoblingsfjeder Varenr.	DKK	SEK
Märke/modell	Årg.	Remskiva racing Art.nr.	Mått	DKK	SEK	Kopplingsstryckfjädrar Art.nr.	DKK	SEK	Centerkopplingsfjädrar Art.nr.	DKK	SEK
PEUGEOT											
Buxy 50	94->	033553	118 mm/ø33	394,-	493,-	033576	143,-	179,-	033602	79,-	99,-
Elyseo 50	98->	033553	118 mm/ø33	394,-	493,-	033576	143,-	179,-	033602	79,-	99,-
Elystar 50	Alle	033553	118 mm/ø33	394,-	493,-	033576	143,-	179,-	033602	79,-	99,-
Fox 50	Alle	033553	118 mm/ø33	394,-	493,-	033576	143,-	179,-	033602	79,-	99,-
Speedake 50	95->	033553	118 mm/ø33	394,-	493,-	033576	143,-	179,-	033602	79,-	99,-
Speedfight -2 AC 50	Alle	033553	118 mm/ø33	394,-	493,-	033576	143,-	179,-	033602	79,-	99,-
Speedfight AC 50	95->	033553	118 mm/ø33	394,-	493,-	033576	143,-	179,-	033602	79,-	99,-
Speedfight LC 50	Alle	033553	118 mm/ø33	394,-	493,-	033576	143,-	179,-	033602	79,-	99,-
Squab 50	95->	033553	118 mm/ø33	394,-	493,-	033576	143,-	179,-	033602	79,-	99,-
Peugeot											
Trekker 50	98->	033553	118 mm/ø33	394,-	493,-	033576	143,-	179,-	033602	79,-	99,-
Trekker/Metal X 50	03->	033553	118 mm/ø33	394,-	493,-						
Vivacity 50	Alle	033553	118 mm/ø33	394,-	493,-	033576	143,-	179,-	033602	79,-	99,-
Zenith 50	94->	033553	118 mm/ø33	394,-	493,-	033576	143,-	179,-	033602	79,-	99,-
PGO											
Big Max 50	Alle	033553	118 mm/ø33	394,-	493,-	033576	143,-	179,-	033602	79,-	99,-
Black Magic 50	Alle	033553	118 mm/ø33	394,-	493,-	033576	143,-	179,-	033602	79,-	99,-
Bubu 50	Alle	033553	118 mm/ø33	394,-	493,-	033576	143,-	179,-	033602	79,-	99,-
Comet 50	Alle	033553	118 mm/ø33	394,-	493,-	033576	143,-	179,-	033602	79,-	99,-
Dr. Big 50	Alle	033553	118 mm/ø33	394,-	493,-	033576	143,-	179,-	033602	79,-	99,-
Galaxy 50	Alle	033553	118 mm/ø33	394,-	493,-	033576	143,-	179,-	033602	79,-	99,-
Hot-50	Alle	033553	118 mm/ø33	394,-	493,-	033576	143,-	179,-	033602	79,-	99,-
Ligero 50	Alle	033553	118 mm/ø33	394,-	493,-	033576	143,-	179,-	033602	79,-	99,-
PMS 50	Alle	033553	118 mm/ø33	394,-	493,-	033576	143,-	179,-	033602	79,-	99,-
PMX 50	Alle	033553	118 mm/ø33	394,-	493,-	033576	143,-	179,-	033602	79,-	99,-
Rodoshow 50	Alle	033553	118 mm/ø33	394,-	493,-	033576	143,-	179,-	033602	79,-	99,-
T-Rex 50	Alle	033553	118 mm/ø33	394,-	493,-	033576	143,-	179,-	033602	79,-	99,-
Tornado 50	Alle	033553	118 mm/ø33	394,-	493,-	033576	143,-	179,-	033602	79,-	99,-
PIAGGIO/VESPA											
ET2 50	97->	033552	129 mm/ø34	394,-	493,-	033576	143,-	179,-	033602	79,-	99,-
NRG Extreme MC3 AC 50	03->	033552	129 mm/ø34	394,-	493,-						
NRG Extreme MC3 LC 50	01->	033552	129 mm/ø34	394,-	493,-	033576	143,-	179,-	033602	79,-	99,-
NRG MC-2 LC 50	94->	033552	129 mm/ø34	394,-	493,-	033576	143,-	179,-	033602	79,-	99,-
Quartz 50	92->	033552	129 mm/ø34	394,-	493,-	033576	143,-	179,-	033602	79,-	99,-
Typhoon 50	Alle	033552	129 mm/ø34	394,-	493,-						
Typhoon-X 50	Alle	033552	129 mm/ø34	394,-	493,-						
Zip 2000 50	00->	033552	129 mm/ø34	394,-	493,-						
Zip 50	93->	033552	129 mm/ø34	394,-	493,-	033576	143,-	179,-	033602	79,-	99,-
SUZUKI											
AP 50 Adress						033575	143,-	179,-			
TR-50 Street Magic						033575	143,-	179,-			
SYM											
Jet 50	Alle	033553	118 mm/ø33	394,-	493,-						
Super Fancy 50	Alle	033553	118 mm/ø33	394,-	493,-						
YAMAHA											
Aerox 50	97->	033551	118 mm/ø34	394,-	394,-	033575	143,-	179,-	033602	79,-	99,-
Aerox-R 50	03->	033551	118 mm/ø34	394,-	394,-						
Axis 50	95->	033551	118 mm/ø34	394,-	394,-	033575	143,-	179,-	033602	79,-	99,-
Bump 50	97->	033551	118 mm/ø34	394,-	394,-	033575	143,-	179,-	033602	79,-	99,-
BW's 50	->96	033550	118 mm/ø33	394,-	493,-	033575	143,-	179,-	033601	79,-	99,-
BW's 50	96->	033551	118 mm/ø34	394,-	394,-	033575	143,-	179,-	033602	79,-	99,-
BW's N.G. 50	->96	033550	118 mm/ø33	394,-	493,-	033575	143,-	179,-	033601	79,-	99,-
BW's N.G. 50	96->	033551	118 mm/ø34	394,-	394,-	033575	143,-	179,-	033602	79,-	99,-
Jog Artistic -Fine Selection 50	Alle	033551	118 mm/ø34	394,-	394,-	033575	143,-	179,-	033602	79,-	99,-
Jog Space Innovation 50	98->	033551	118 mm/ø34	394,-	394,-	033575	143,-	179,-			
Jog-R 50	03	033551	118 mm/ø34	394,-	394,-						
Jog-RR 50	03	033551	118 mm/ø34	394,-	394,-						
Neo's 50	97->	033551	118 mm/ø34	394,-	394,-	033575	143,-	179,-	033602	79,-	99,-
Slider 50	01->	033551	118 mm/ø34	394,-	394,-	033575	143,-	179,-	033602	79,-	99,-
Spy 50	Alle	033551	118 mm/ø34	394,-	394,-	033575	143,-	179,-	033601	79,-	99,-
Why 50	99->	033551	118 mm/ø34	394,-	394,-						



Mærke/model	Årg.	Kobling standard Varenr.	Mål	Kobling racing Varenr.	Mål	Koblingskål Varenr.	Mål
Mærke/modell	Årg.	Koppling standard Art.nr.	Mått	Koppling racing Art.nr.	Mått	Lamellkorg Art.nr.	Mått
ADLY							
Cat 50	Alle	033501	107 mm	033526	107 mm	034527	107 mm
Jet 50	Alle	033501	107 mm	033526	107 mm	034527	107 mm
Silver Fox 50	Alle	033501	107 mm	033526	107 mm	034527	107 mm
Super Sonic 50	Alle	033501	107 mm	033526	107 mm	034527	107 mm
Thunder Bike 50	Alle	033501	107 mm	033526	107 mm	034527	107 mm
APRILIA							
Amico 50	>96	033500	105 mm	033525	105 mm	034526	105 mm
Amico 50	96>	033501	107 mm	033526	107 mm	034527	107 mm
Area 51 LC 50	98>	033501	107 mm	033526	107 mm	034527	107 mm
Gulliver 50	>96	033500	105 mm	033525	105 mm	034526	105 mm
Gulliver 50	96>	033501	107 mm	033526	107 mm	034527	107 mm
Habana AC (Morini) 50	Alle	033202	107 mm				
Rally AC 50	>96	033500	105 mm	033525	105 mm	034526	105 mm
Rally AC 50	96>	033501	107 mm	033526	107 mm	034527	107 mm
Rally LC 50	96>	033501	107 mm	033526	107 mm	034527	107 mm
Scarabeo 50	>96	033500	105 mm	033525	105 mm	034526	105 mm
Scarabeo 50	96>	033501	107 mm	033526	107 mm	034527	107 mm
Scarabeo Ditech (Morini) 50	02>	033202	107 mm				
Sonic AC 50	Alle	033501	107 mm	033526	107 mm	034527	107 mm
Sonic LC 50	Alle	033501	107 mm	033526	107 mm	034527	107 mm
SR - Ditech (Morini) 50	Alle	033202	107 mm				
SR - www AC 50	97>	033501	107 mm	033526	107 mm	034527	107 mm
SR-50 AC 50	>96	033500	105 mm	033525	105 mm	034526	105 mm
SR-50 AC/LC 50	96>	033501	107 mm	033526	107 mm	034527	107 mm
SR-Racing 50, Stealth, Netscaper LC	Alle	033501	107 mm	033526	107 mm	034527	107 mm
SR-Replica LC (Minarelli) 50	>00	033501	107 mm	033526	107 mm	034527	107 mm
SR-Replica-2000 LC (Morini) 50	00>	033202	107 mm				
ATALA							
Carosello 50	96>	033501	107 mm	033526	107 mm	034527	107 mm
Hacker AT-12 50	Alle	033202	107 mm				
Hacker LC 50	Alle	033202	107 mm				
Skeggia 50	Alle	033202	107 mm				
BENELLI							
491 GT 50	97>	033501	107 mm	033526	107 mm	034527	107 mm
491 Sport 50	97>	033501	107 mm	033526	107 mm	034527	107 mm
K2/LC 50	>96	033500	105 mm	033525	105 mm	034526	105 mm
K2/LC 50	96>	033501	107 mm	033526	107 mm	034527	107 mm
BETA							
Ark AC/LC 50	>96	033500	105 mm	033525	105 mm	034526	105 mm
Ark AC/LC 50	96>	033501	107 mm	033526	107 mm	034527	107 mm
CPI							
Hussar 50	Alle	033502	112 mm			034528	112 mm
Oliver/City 50 (Euro 2)	03>	033502	112 mm			034528	112 mm
Popcorn 50	Alle	033502	112 mm			034528	112 mm
DERBI							
Atlantis 50	03>	033501	107 mm	033526	107 mm	034525	107 mm
Atlantis 50		033202	107 mm				
GP1 50		033501	107 mm	033526	107 mm	034525	107 mm
Hunter 50		033202	107 mm				
Manhattan 50		033202	107 mm				
MotoGP (GP1) 50		033202	107 mm				
Paddock AC 50		033202	107 mm				
Predator LC 50		033202	107 mm				
Vamos (Morini) 50	Alle	033202	107 mm				
FALCON							
Big Wheel 50	Alle	033501	107 mm	033526	107 mm	034527	107 mm
Star-50	Alle	033501	107 mm	033526	107 mm	034527	107 mm
GENERIC							
Ideo 50	Alle	033502	112 mm			034528	112 mm
Race 50	Alle	033502	112 mm			034528	112 mm
XOR 2 50	Alle	033502	112 mm			034528	112 mm
GILERA							
DNA LC 50	Alle	033501	107 mm	033526	107 mm	034525	107 mm
ICE AC 50	Alle	033501	107 mm	033526	107 mm	034525	107 mm
Runner AC 50	Alle	033501	107 mm	033526	107 mm	034525	107 mm
Runner LC 50	Alle	033501	107 mm	033526	107 mm	034525	107 mm
Runner PJ 50	03>	033501	107 mm	033526	107 mm	034525	107 mm
Runner SP LC 50	02>	033501	107 mm	033526	107 mm	034525	107 mm
Stalker 50	Alle	033501	107 mm	033526	107 mm	034525	107 mm
Typhoon 50	Alle	033501	107 mm	033526	107 mm	034525	107 mm
Typhoon-X 50	02>	033501	107 mm	033526	107 mm	034525	107 mm
HONDA							
Melody 50	Alle						

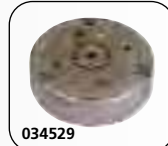
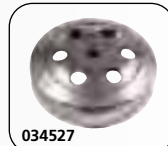

NY
NY
NY

🇩🇰 Sådan måler du diameteren på en koblings-skål...

Kontrollér at målene svarer til centerkoblingen, da de udgør et sæt hvor diameteren på henholdsvis centerkobling og koblings-skål skal passe sammen.

🇸🇪 Så mäter du diameteren på en kopplings-skål...

Kontrollera att måttet stämmer med centerkopplingen då dessa ingår i ett kit där diameteren på centerkoppling och kopplings-skål skall passa ihop.



Mærke/model	Årg.	Kobling standard Varenr.	Mål	DKK	SEK	Kobling racing Varenr.	Mål	DKK	SEK	Koblingskål Varenr.	Mål	DKK	SEK
Mærke/modell	Årg.	Koppling standard Art.nr.	Mått	DKK	SEK	Koppling racing Art.nr.	Mått	DKK	SEK	Lamellkorg Art.nr.	Mått	DKK	SEK
HONDA													
SFX 50	Alle	033501	107 mm	289,-	361,-	033526	107 mm	394,-	493,-				
Sky 50	Alle	033501	107 mm	289,-	361,-	033526	107 mm	394,-	493,-				
Vision Met In 50	Alle	033001		352,-	361,-	033526	107 mm	394,-	493,-				
Vision SA 50	Alle	033001		352,-	361,-	033526	107 mm	394,-	493,-				
X8-R 50	Alle	033501		289,-	361,-	033526	107 mm	394,-	493,-				
HYOSUNG													
SB 50 m (Cab)	99>	033202	107 mm	352,-	440,-					034529	107 mm	316,-	395,-
SF 50 B (Racing)	00>	033202	107 mm	352,-	440,-					034529	107 mm	316,-	395,-
SF 50 R (Rally)	00>	033202	107 mm	352,-	440,-					034529	107 mm	316,-	395,-
ITALJET													
Formula 50	Alle	033202	107 mm	352,-	440,-								
Velocifero 50	Alle	033202	107 mm	352,-	440,-								
KEEWAY													
F-act 50	Alle	033502	112 mm	289,-	440,-					034528	112 mm	316,-	395,-
Flash 50	Alle	033502	112 mm	289,-	440,-					034528	112 mm	316,-	395,-
Focus 50	Alle	033502	112 mm	289,-	440,-					034528	112 mm	316,-	395,-
Matrix 50	Alle	033502	112 mm	289,-	440,-					034528	112 mm	316,-	395,-
KYMCO													
K-12 50	Alle	033501	107 mm	289,-	361,-	033526	107 mm	394,-	493,-	034525	107 mm	213,-	266,-
NZ-50 Super Fever	03>	033501	107 mm	289,-	361,-	033526	107 mm	394,-	493,-	034525	107 mm	213,-	266,-
MALAGUTI													
F10 AC 50	Alle	033501	107 mm	289,-	361,-	033526	107 mm	394,-	493,-	034527	107 mm	213,-	266,-
F12 Phantom AC 50	Alle	033501	107 mm	289,-	361,-	033526	107 mm	394,-	493,-	034527	107 mm	213,-	266,-
F15 Firefox LC 50	Alle	033501	107 mm	289,-	361,-	033526	107 mm	394,-	493,-	034527	107 mm	213,-	266,-
PEUGEOT													
Buxy 50	94>	033501	107 mm	289,-	361,-	033526	107 mm	394,-	493,-	034525	107 mm	213,-	266,-
Elyseo 50	98>	033501	107 mm	289,-	361,-	033526	107 mm	394,-	493,-	034525	107 mm	213,-	266,-
Elystar 50	Alle	033501	107 mm	289,-	361,-	033526	107 mm	394,-	493,-	034525	107 mm	213,-	266,-
Fox 50	Alle	033501	107 mm	289,-	361,-	033526	107 mm	394,-	493,-	034525	107 mm	213,-	266,-
Speedake 50	95>	033501	107 mm	289,-	361,-	033526	107 mm	394,-	493,-	034525	107 mm	213,-	266,-
Speedfight -2 AC 50	Alle	033501	107 mm	289,-	361,-	033526	107 mm	394,-	493,-	034525	107 mm	213,-	266,-
Speedfight AC 50	95>	033501	107 mm	289,-	361,-	033526	107 mm	394,-	493,-	034525	107 mm	213,-	266,-
Speedfight LC 50	Alle	033501	107 mm	289,-	361,-	033526	107 mm	394,-	493,-	034525	107 mm	213,-	266,-
Squab 50	95>	033501	107 mm	289,-	361,-	033526	107 mm	394,-	493,-	034525	107 mm	213,-	266,-
Trekker 50	98>	033501	107 mm	289,-	361,-	033526	107 mm	394,-	493,-	034525	107 mm	213,-	266,-
Trekker/Metal X 50	03>	033501	107 mm	289,-	361,-	033526	107 mm	394,-	493,-	034525	107 mm	213,-	266,-
Vivacity 50	Alle	033501	107 mm	289,-	361,-	033526	107 mm	394,-	493,-	034525	107 mm	213,-	266,-
Zenith 50	94>	033501	107 mm	289,-	361,-	033526	107 mm	394,-	493,-	034525	107 mm	213,-	266,-
PGO													
Big Max 50	Alle	033501	107 mm	289,-	361,-	033526	107 mm	394,-	493,-	034525	107 mm	213,-	266,-
Black Magic 50	Alle	033501	107 mm	289,-	361,-	033526	107 mm	394,-	493,-	034525	107 mm	213,-	266,-
Bubu 50	Alle	033501	107 mm	289,-	361,-	033526	107 mm	394,-	493,-	034525	107 mm	213,-	266,-
Comet 50	Alle	033501	107 mm	289,-	361,-	033526	107 mm	394,-	493,-	034525	107 mm	213,-	266,-
Dr. Big 50	Alle	033501	107 mm	289,-	361,-	033526	107 mm	394,-	493,-	034525	107 mm	213,-	266,-
Galaxy 50	Alle	033501	107 mm	289,-	361,-	033526	107 mm	394,-	493,-	034525	107 mm	213,-	266,-
Hot-50	Alle	033501	107 mm	289,-	361,-	033526	107 mm	394,-	493,-	034525	107 mm	213,-	266,-
Ligero 50	Alle	033501	107 mm	289,-	361,-	033526	107 mm	394,-	493,-	034525	107 mm	213,-	266,-
PMS 50	Alle	033501	107 mm	289,-	361,-	033526	107 mm	394,-	493,-	034525	107 mm	213,-	266,-
PMX 50	Alle	033501	107 mm	289,-	361,-	033526	107 mm	394,-	493,-	034525	107 mm	213,-	266,-
Rodoshow 50	Alle	033501	107 mm	289,-	361,-	033526	107 mm	394,-	493,-	034525	107 mm	213,-	266,-
T-Rex 50	Alle	033501	107 mm	289,-	361,-	033526	107 mm	394,-	493,-	034525	107 mm	213,-	266,-
Tornado 50	Alle	033501	107 mm	289,-	361,-	033526	107 mm	394,-	493,-	034525	107 mm	213,-	266,-
PIAGGIO/VESPA													
ET2 50	97->	033501	107 mm	289,-	361,-	033526	107 mm	394,-	493,-	034525	107 mm	213,-	266,-
NRG Extreme MC3 AC 50	Alle	033501	107 mm	289,-	361,-	033526	107 mm	394,-	493,-	034525	107 mm	213,-	266,-
NRG Extreme MC3 LC 50	Alle	033501	107 mm	289,-	361,-	033526	107 mm	394,-	493,-	034525	107 mm	213,-	266,-
NRG MC-2 LC 50	94-	033501	107 mm	289,-	361,-	033526	107 mm	394,-	493,-	034525	107 mm	213,-	266,-
Typhoon 50	Alle	033501	107 mm	289,-	361,-	033526	107 mm	394,-	493,-	034525	107 mm	213,-	266,-
Typhoon-X 50	Alle	033501	107 mm	289,-	361,-	033526	107 mm	394,-	493,-	034525	107 mm	213,-	266,-
Zip 2000 50	00->	033501	107 mm	289,-	361,-	033526	107 mm	394,-	493,-	034525	107 mm	213,-	266,-
Zip 50	93->	033501	107 mm	289,-	361,-	033526	107 mm	394,-	493,-	034525	107 mm	213,-	266,-
Zip 50 - 4-Takt	00->	033501	107 mm	289,-	361,-	033526	107 mm	394,-	493,-				
PUCH													
Maxi P/K 50	Alle	033503		289,-	361,-								
SUZUKI													
Adress AP-50	Alle	033202	107 mm	352,-	440,-					034529	107 mm	316,-	395,-
Estilete, UF-50	Alle	033202	107 mm	352,-	440,-					034529	107 mm	316,-	395,-
FZ-50	Alle	033202	107 mm	352,-	440,-								
Katana AY-50 AC	Alle	033202	107 mm	352,-	440,-					034529	107 mm	316,-	395,-
Katana AY-50 AC/LC	00>	033202	107 mm	352,-	440,-					034529	107 mm	316,-	395,-
Katana AY-50 LC	Alle	033202	107 mm	352,-	440,-					034529	107 mm	316,-	395,-
LT 50 (ATV)	Alle	033201		352,-	361,-								

Forhandlere
Återförsäljare
s. 2

Stikord
Sökord
s. 4

Tøj/hjelme
Klæder/
hjelmar
s. 6

Dæk og
slanger
Dæk og
slangar
s. 15

Olie / spray
Olja / spray
s. 26

Kæder /
tandhjul
Kedjor /
drev
s. 43

Bremsedele
Bromsdelar
s. 48

Låse
Lås
s. 93

Batteri
Batteri
s. 96

Cylinder /
topstykke
Cylinder /
topplöck
s. 105

Motordele
Motordelar
s. 137

Karburator -
Lufffilter
Förgasare -
Lufffilter
s. 208

El-dele
tændrør
Elektriskt
tændstift
s. 222

Udstødning
Avgassystem
s. 246

Forgaffel
Støddæmpere
Framgaffel
Støddämpare
s. 260

Kabler
Wire
s. 266

Styr og
greb
Styre och
handtag
s. 272

Spejle
Speglar
s. 282

Blinklygter
Baglygter
Blinkers
Baklykte
s. 284

Støtteben
Topboks, mm.
Stödd
Topbbox, mm
s. 291

Rep. bøger
værktøj
Rep. böcker
Verktyg
s. 297



Mærke/model	Årg.	Kobling standard Varenr.	Mål			Kobling racing Varenr.	Mål			Koblingskål Varenr.	Mål		
Mærke/modell	Årg.	Koppling standard Art.nr.	Mått	DKK	SEK	Koppling racing Art.nr.	Mått	DKK	SEK	Lamellkorg Art.nr.	Mått	DKK	SEK
SUZUKI													
Street Magic, TR-50S	Alle	033202	107 mm	352,-	440,-					034529	107 mm	316,-	395,-
Zillion LC, UX-50	Alle	033202	107 mm	352,-	440,-					034529	107 mm	316,-	395,-
SYM													
Jet 50	Alle	033202	107 mm	352,-	440,-								
Super Fancy 50	Alle	033202	107 mm	352,-	440,-								
TGB/TOBI													
303/309 50	Alle	033202	107 mm	352,-	440,-					034529	107 mm	316,-	395,-
Akros 50	Alle	033202	107 mm	352,-	440,-					034529	107 mm	316,-	395,-
YAMAHA													
Aerox 50	97>	033501	107 mm	289,-	361,-	033526	107 mm	394,-	493,-	034527	107 mm	213,-	266,-
Axis 50	95>	033501	107 mm	289,-	361,-	033526	107 mm	394,-	493,-	034527	107 mm	213,-	266,-
Bump 50	97>	033501	107 mm	289,-	361,-	033526	107 mm	394,-	493,-	034527	107 mm	213,-	266,-
BW's 50	>96	033500	105 mm	289,-	361,-	033525	105 mm	394,-	493,-	034526	105 mm	213,-	266,-
BW's N.G. 50	96>	033501	107 mm	289,-	361,-	033526	107 mm	394,-	493,-	034527	107 mm	213,-	266,-
Jog Artistic - Fine Selection 50	>96	033500	105 mm	289,-	361,-	033525	105 mm	394,-	493,-	034527	107 mm	213,-	266,-
Jog Space Innovation 50	98>	033501	107 mm	289,-	361,-	033526	107 mm	394,-	493,-	034527	107 mm	213,-	266,-
Jog-R 50	03>	033501	107 mm	289,-	361,-	033526	107 mm	394,-	493,-	034527	107 mm	213,-	266,-
Jog-RR 50	03>	033501	107 mm	289,-	361,-	033526	107 mm	394,-	493,-	034527	107 mm	213,-	266,-
Neo's 50	97>	033501	107 mm	289,-	361,-	033526	107 mm	394,-	493,-	034527	107 mm	213,-	266,-
Slider 50	01>	033501	107 mm	289,-	361,-	033526	107 mm	394,-	493,-	034527	107 mm	213,-	266,-
Spy 50	Alle	033501	107 mm	289,-	361,-	033526	107 mm	394,-	493,-	034527	107 mm	213,-	266,-
Why 50	99>	033501	107 mm	289,-	361,-	033526	107 mm	394,-	493,-	034527	107 mm	213,-	266,-



MÆRKE/MODEL	ÅRG.	Varenr.		
MÆRKE/MODELL	ÅRG.	Art.NR.	DKK	SEK
ADLY				
Cat 50	Alle	173693	105,-	131,-
Jet 50	Alle	173693	105,-	131,-
Silver Fox 50	Alle	173693	105,-	131,-
Super Sonic 50	Alle	173693	105,-	131,-
Thunder Bike 50	Alle	173693	105,-	131,-
APRILIA				
Amico 50	Alle	173690	105,-	131,-
Area 51 LC 50	98->	173690	105,-	131,-
Classic 50	Alle	173690	105,-	131,-
Gulliver 50	Alle	173690	105,-	131,-
Rally AC 50	Alle	173690	105,-	131,-
RS 50 (AM-6)	Alle	173696	155,-	194,-
Scarabeo 50	Alle	173690	105,-	131,-
Sonic AC 50	98->	173690	105,-	131,-
Sonic LC 50	Alle	173690	105,-	131,-
SR - www AC 50	97->	173690	105,-	131,-
SR-50 AC	->96	173690	105,-	131,-
SR-Racing 50, Stealth, Netscaper LC	Alle	173690	105,-	131,-
SR-Replica LC (Minarelli) 50	->00	173690	105,-	131,-
SX 50	07>	173697	155,-	194,-
ATALA				
Carosello 50	Alle	173693	105,-	131,-
AVANTI				
9 N 50 (4 t.)	Alle	173698	103,-	129,-
Sport Classic 50 (4 t.)	Alle	173698	103,-	129,-
Eagle 50 (4 t.)	Alle	173698	103,-	129,-
Avanti Wolf 50 (4 t.)	Alle	173698	103,-	129,-
BAOTAIN				
BT49QT-7 50 (4 t.)	Alle	173698	103,-	129,-
BT49QT-9 50 (4 t.)	Alle	173698	103,-	129,-
BT49QT-11 50 (4 t.)	Alle	173698	103,-	129,-
BT49QT-12C 50 (4 t.)	Alle	173698	103,-	129,-
BT49QT-12 1 50 (4 t.)	Alle	173698	103,-	129,-
BENDA				
Scot 50 (4 t.)	Alle	173698	103,-	129,-
BENELLI				
491 GT 50	97->	173692	105,-	131,-
491 Sport 50	97->	173692	105,-	131,-
K2/LC 50	Alle	173692	105,-	131,-

MÆRKE/MODEL	ÅRG.	Varenr.		
MÆRKE/MODELL	ÅRG.	Art.NR.	DKK	SEK
BETA				
Ark AC 50	Alle	173693	105,-	131,-
Ark LC 50	Alle	173693	105,-	131,-
CPI				
Aragon 50 (Euro 2)	Alle	173695	155,-	194,-
ATV 50 cc		173695	155,-	194,-
Formula R 50 (Euro 2)	Alle	173695	155,-	194,-
Hussar 50	Alle	173695	155,-	194,-
Oliver/City 50 (Euro 2)	03->	173695	155,-	194,-
Popcorn 50	Alle	173695	155,-	194,-
DERBI				
Atlantis 50	03->	173691	105,-	131,-
GP1 50	03->	173691	105,-	131,-
Senda 50	Alle	173697	155,-	194,-
Senda X-treme 50	Alle	173697	155,-	194,-
Falcon				
Big Wheel 50	Alle	173693	105,-	131,-
Star-50	Alle	173693	105,-	131,-
FYM				
QT 50 (4 t.)	Alle	173698	103,-	129,-
GENERIC				
Race 50	Alle	173695	155,-	194,-
Trigger SM 50	Alle	173696	155,-	194,-
Trigger X 50	Alle	173696	155,-	194,-
GIANTCO				
G-Buddy 50 (4 t.)	Alle	173698	103,-	129,-
Sprint 50 (4 t.)	Alle	173698	103,-	129,-
Stealth 50 (4 t.)	Alle	173698	103,-	129,-
Venus 50 (4 t.)	Alle	173698	103,-	129,-
GILERA				
DNA LC 50	Alle	173691	105,-	131,-
ICE AC 50	Alle	173691	105,-	131,-
Runner AC 50	Alle	173691	105,-	131,-
Runner LC 50	Alle	173691	105,-	131,-
Runner PJ 50	03->	173691	105,-	131,-
Runner SP LC 50	02->	173691	105,-	131,-
Stalker 50	Alle	173691	105,-	131,-
Typhoon 50	->01	173691	105,-	131,-
Typhoon-X 50	02->	173691	105,-	131,-

M/ÆRKE/MODEL	ÅRG.	Varenr.	DKK	SEK
MÄRKE/MODELL	ÅRG.	Art.NR.	DKK	SEK
HOOPER				
One 50 (4 t.)	Alle	173698	103,-	129,-
HYOSUNG				
SB 50 M (Cab)	99->	173689	198,-	248,-
KEEWAY				
F-act 50	Alle	173695	155,-	194,-
Flash 50	Alle	173695	155,-	194,-
Focus 50	Alle	173695	155,-	194,-
Matrix 50	Alle	173695	155,-	194,-
MALAGUTI				
F10 AC 50	Alle	173693	105,-	131,-
F12 Phantom AC 50	Alle	173693	105,-	131,-
F15 Firefox LC 50	Alle	173693	105,-	131,-
PEUGEOT				
Buxy 50	94->	173694	105,-	131,-
Elyseo 50	98->	173694	105,-	131,-
Elyseo 50	03->	173694	105,-	131,-
Fox 25 50	03->	173694	105,-	131,-
Speedake 50	95->	173694	105,-	131,-
Speedfight -2 AC 50	Alle	173694	105,-	131,-
Speedfight AC 50	95->	173694	105,-	131,-
Speedfight LC 50	Alle	173694	105,-	131,-
Squab 50	95->	173694	105,-	131,-
Trekker 50	98->	173694	105,-	131,-
Trekker/Metal X 50	03->	173694	105,-	131,-
V-Clic 50 (4 t.)	Alle	173698	103,-	129,-
Vivacity 50	Alle	173694	105,-	131,-
Zenith 50	94->	173694	105,-	131,-
PEXMA				
KDQT 50 (4 t.)	Alle	173698	103,-	129,-
PGO				
Big Max 50	Alle	173699	105,-	131,-
Black Magic 50	Alle	173699	105,-	131,-
Bubu 50	Alle	173699	105,-	131,-
Comet 50	Alle	173699	105,-	131,-
Dr. Big 50	Alle	173699	105,-	131,-
Galaxy 50	Alle	173699	105,-	131,-
Hot-50	Alle	173699	105,-	131,-
Ligero 50	Alle	173699	105,-	131,-
PMS 50	Alle	173699	105,-	131,-
PMX 50	Alle	173699	105,-	131,-
Rodoshow 50	Alle	173699	105,-	131,-
T-Rex 50	Alle	173699	105,-	131,-
Tornado 50	Alle	173699	105,-	131,-
PIAGGIO/VESPA				
ET2 50	97->	173691	105,-	131,-
NRG Extreme MC3 AC 50	03->	173691	105,-	131,-
NRG Extreme MC3 LC 50	01->	173691	105,-	131,-
NRG MC-2 LC 50	94->	173691	105,-	131,-

M/ÆRKE/MODEL	ÅRG.	Varenr.	DKK	SEK
MÄRKE/MODELL	ÅRG.	Art.NR.	DKK	SEK
PIAGGIO/VESPA				
Typhoon 50	Alle	173691	105,-	131,-
Typhoon-X 50	Alle	173691	105,-	131,-
Zip 2000 50	00->	173691	105,-	131,-
Zip 50	93->	173691	105,-	131,-
Zip 4-Takt 50	00->	173691	105,-	131,-
RIEJU				
Alle modeller (m. AM-6 motor)	Alle	173696	155,-	194,-
SANELI				
Bahne 50 (4 t.)	Alle	173698	103,-	129,-
STRANGER				
X-fight 50 (4 t.)	Alle	173698	103,-	129,-
SUZUKI				
Estilete 50	Alle	173912	245,-	306,-
Katana 50 AC/LC	Alle	173912	245,-	306,-
RMX 50	Alle	173913	245,-	306,-
SMX 50	Alle	173913	245,-	306,-
Zillion 50	Alle	173912	245,-	306,-
TEXAS				
Chili 50 (4 t.)	Alle	173698	103,-	129,-
City 50 (4 t.)	Alle	173698	103,-	129,-
Flash 50 (4 t.)	Alle	173698	103,-	129,-
Free 50 (4 t.)	Alle	173698	103,-	129,-
TMS				
Retro 50 (4 t.)	Alle	173698	103,-	129,-
S3 50 (4 t.)	Alle	173698	103,-	129,-
Z2 50 (4 t.)	Alle	173698	103,-	129,-
TOBILINER				
QT 50 (4 t.)	Alle	173698	103,-	129,-
YAMAHA				
Aerox 50	97->	173693	105,-	131,-
ATV 50 cc	Alle	173693	105,-	131,-
Axis 50	95->	173693	105,-	131,-
Bump 50	97->	173693	105,-	131,-
BW's 50	Alle	173693	105,-	131,-
BW's N.G. 50	Alle	173693	105,-	131,-
Jog Artistic - Fine Selection 50	Alle	173693	105,-	131,-
Jog Space Innovation 50	98->	173693	105,-	131,-
Jog-R 50	03->	173693	105,-	131,-
Jog-RR 50	03->	173693	105,-	131,-
Neo's 50	97->	173693	105,-	131,-
Slider 50	01->	173693	105,-	131,-
Spy 50	Alle	173693	105,-	131,-
TZR 50 (AM-6)	Alle	173696	155,-	131,-
Why 50	99->	173693	105,-	131,-
YIYANG				
Stranger 50 (4 t.)	Alle	173698	103,-	129,-

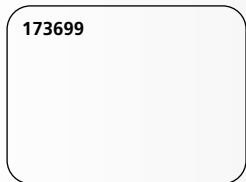
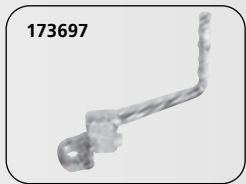
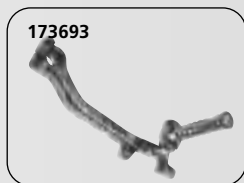
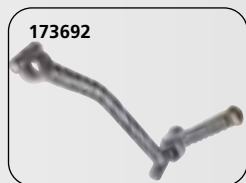

MOTORDÆKSEL VED KICKSTARTER
MOTORKÅPA VID KICKEN



MÆRKE/MODEL	ÅRG.	Varenr.		
MÄRKE/MODELL	ÅRG.	Art.NR.	DKK	SEK
AVANTI				
9 N 50 (4 t.)	Alle	110300	399,-	499,-
BAOTAIN				
BT49QT-7 50	Alle	110300	399,-	499,-
BT49QT-11 50	Alle	110300	399,-	499,-
FYM				
QT 50 (4 t.)	Alle	110300	399,-	499,-
GIANTCO				
G-Buddy 50 (4 t.)	Alle	110300	399,-	499,-
Venus 50 (4 t.)	Alle	110300	399,-	499,-
KYMCO				
Agility 50 (4 t.) (10")	Alle	110300	399,-	499,-
PEUGEOT				
V-Clic 50 (4 t.)	Alle	110300	399,-	499,-
PEXMA				
KDQT 50 (4 t.)	Alle	110300	399,-	499,-
SANELI				
Bahne 50 (4 t.)	Alle	110300	399,-	499,-
TEXAS				
City 50 (4 t.)	Alle	110300	399,-	499,-
Flash 50 (4 t.)	Alle	110300	399,-	499,-
Free 50 (4 t.)	Alle	110300	399,-	499,-
TMS				
Retro 50 (4 t.)	Alle	110300	399,-	499,-
S3 50 (4 t.)	Alle	110300	399,-	499,-
YIYING				
Stranger 50 (4 t.)	Alle	110300	399,-	499,-

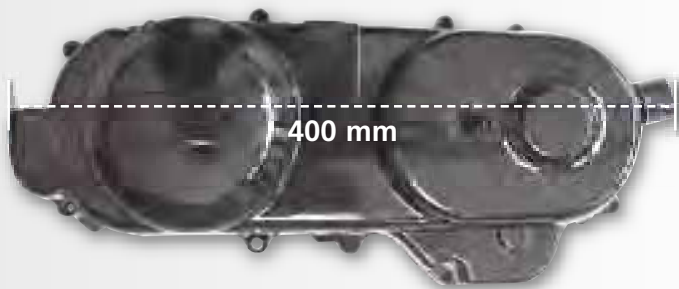

MAX

GEARSKIFTERPEDAL
VÄXELSPARK



MÆRKE/MODEL	ÅRG.	Varenr.		
MÄRKE/MODELL	ÅRG.	Art.NR.	DKK	SEK
APRILIA				
RS 50 (AM-6)	Alle	173648	155,-	194,-
SX 50	07>	173649	155,-	194,-
DERBI				
Senda 50	Alle	173649	155,-	194,-
Senda X-treme 50	Alle	173649	155,-	194,-
GENERIC				
Trigger SM 50	Alle	173648	155,-	194,-
Trigger X 50	Alle	173648	155,-	194,-
RIEJU				
Alle modeller 50 cc (m. AM-6 motor)	Alle	173648	155,-	194,-
YAMAHA				
TZR 50 (AM-6)	Alle	173648	155,-	194,-

173648

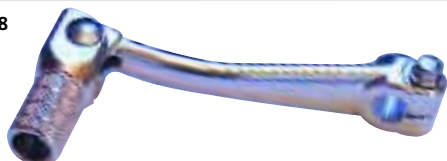

173649



TRANSMISSIONSDÆKSEL TIL 4 TAKTERE
TRANSMISSIONSKÅPA FÖR 4 STROKE



Forhandlere
Återförsäljare
s. 2

Stikord
Sökord
s. 4

Tøj/hjelme
Kläder/
hjälmor
s. 6

Dæk og
slanger
Däck och
slangor
s. 15

Olje / spray
Olja / spray
s. 26

Kæder /
tandhjul
Kedjor /
drev
s. 43

Bremselede
Bromsdelar
s. 48

Låse
Lås
s. 93

Batteri
Batteri
s. 96

Cylinder /
topstykke
Cylinder /
topplock
s. 105

Motordele
Motordele
s. 137

Karburator
- Luftfilter
Förgasare
- Luftfilter
s. 208

El-dele
tændrør
Elektriskt
tändstift
s. 222

Udstødning
Avgassystem
s. 246

Forgaffel
Støddæmpere
Framgaffel
Støtdämpare
s. 260

Kabler
Wire
s. 266

Styr og
greb
Styre och
handtag
s. 272

Spejle
Speglar
s. 282

Blinklygter
Baglygter
Blinkers
Baklykte
s. 284

Støtteben
Topboks, mm.
Stödd
Toppbox, mm
s. 291

Rep. bøger
værktøj
Rep. böcker
Verktyg
s. 297



MÆRKE/MODEL	ÅRG.
AVANTI	ÅRG.
9 N 50 (4 t.)	Alle
Sport Classic 50 (4 t.)	Alle
Eagle 50 (4 t.)	Alle
Avanti Wolf 50 (4 t.)	Alle
BAOTAIN	
BT49QT-7 50 (4 t.)	Alle
BT49QT-9 (4 t.)	Alle
BT49QT-11 (4 t.)	Alle
BT49QT-12C (4 t.)	Alle
BT49QT-12 (4 t.)	Alle
FYM	
QT 50 (4 t.)	Alle
GIANTCO	
G-Buddy 50 (4 t.)	Alle
Sprint 50 (4 t.)	Alle
Stealth 50 (4 t.)	Alle
Venus 50 (4 t.)	Alle
HOOPER	
One 50 (4 t.)	Alle
KYMCO	
Agility 50 (4 t.)	Alle
Super 8 50 (4 t.)	Alle
PEUGEOT	
V-Clic 50 (4 t.)	Alle
PEXMA	
KDOT 50 (4 t.)	Alle
SANELI	
Bahne 50 (4 t.)	Alle
TEXAS	
Chili 50 (4 t.)	Alle
City 50 (4 t.)	Alle
Flash 50 (4 t.)	Alle
Free 50 (4 t.)	Alle
TMS	
Retro 50 (4 t.)	Alle
S3 50 (4 t.)	Alle
Z2 50 (4 t.)	Alle
YIYING	
Stranger 50 (4 t.)	Alle

Dæksel

 Varenr./art.nr. 110301 **598,-** **748,-**

Pakdåser
Packboxar

 Varenr./art.nr. 800359 **78,-** **98,-**

Lejer
Lager

 Varenr./art.nr. 110310 **199,-** **249,-**



MAX
MC Parts

TRANSMISSIONSDÆKSEL TIL 2 TAKTERE
TRANSMISSIONSKÅPA FÖR 2 STROKE



MÆRKE/MODEL	ÅRG.
CPI	ÅRG.
Aragon 50	Alle
Formula R 50	Alle
Hussar 50	Alle
Oliver/City 50	Alle
Popcorn 50	Alle
GENERIC	
Ideo 50	Alle
Race 50	Alle
XOR 2 50	Alle
KEEWAY	
Flash 50	Alle
Focus 50	Alle
Matrix 50	Alle
Hurricane 50	Alle
F-act 50	Alle

Dæksel

 Varenr./art.nr. 110302 **598,-** **748,-**

Pakdåser
Packboxar

 Varenr./art.nr. 800353 **85,-** **106,-**

Lejer
Lager

 Varenr./art.nr. 110311 **1260,-** **1575,-**



Mærke/model	Årg.	Kickstarteraksels Varenr.	Spec.	DKK	SEK	Fjeder for kickstarteraksels Varenr.	DKK	SEK
Mærke/modell	Årg.	Kickstart axels Art.nr.	Spec.	DKK	SEK	Fjäder för kickstart axels Art.nr.	DKK	SEK
AVANTI								
9 N 50 (4 t.)	Alle	110016		98,-	123,-	110032	59,-	74,-
Sport Classic 50 (4 t.)	Alle	110016		98,-	123,-	110032	59,-	74,-
Eagle 50 (4 t.)	Alle	110016		98,-	123,-	110032	59,-	74,-
Avanti Wolf 50 (4 t.)	Alle	110016		98,-	123,-	110032	59,-	74,-
APRILIA								
(Vandret cylinder)		110010	Lige type	138,-	173,-	110030	57,-	71,-
(Lodret cylinder)		110011	Buet type	138,-	173,-	110030	57,-	71,-
BAOTAIN								
BT-QT-8/11 50 (4 t.)	Alle	110016		98,-	123,-	110032	59,-	74,-
BT49QT-7 (4 t.)	Alle	110016		98,-	123,-	110032	59,-	74,-
BT49QT-9 (4 t.)	Alle	110016		98,-	123,-	110032	59,-	74,-
BT49QT-11 (4 t.)	Alle	110016		98,-	123,-	110032	59,-	74,-
BT49QT-12Wolf 50 (4 t.)	Alle	110016		98,-	123,-	110032	59,-	74,-
BT49QT-12C (4 t.)	Alle	110016		98,-	123,-	110032	59,-	74,-
Supermoto 50 (4 t.)	Alle	110016		98,-	123,-	110032	59,-	74,-
BENDA								
Scoot 50 (4 t.)	Alle	110016		98,-	123,-	110032	59,-	74,-
CPI								
Hussar 50 - Euro 2	Alle	110014	Lgd. 80mm	138,-	173,-	110030	57,-	71,-
Hussar 50 - Euro 1	Alle	110013	Lgd. 65mm	135,-	169,-	110030	57,-	71,-
Oliver/City 50 - (Euro 2)	Alle	110014	Lgd. 80mm	138,-	173,-	110030	57,-	71,-
Oliver 50 - Euro 1	Alle	110013	Lgd. 65mm	135,-	169,-	110030	57,-	71,-
Popcorn 50 - Euro 2	Alle	110014	Lgd. 80mm	138,-	173,-	110030	57,-	71,-
Popcorn 50 - Euro 1	Alle	110013	Lgd. 65mm	135,-	169,-	110030	57,-	71,-
FYM								
QT 50	Alle	110016		98,-	123,-	110032	59,-	74,-
GENERIC								
Ideo 50	Alle	110014		138,-	173,-	110030	57,-	71,-
Race 50	Alle	110014		138,-	173,-	110030	57,-	71,-
XOR 2 50	Alle	110014		138,-	173,-	110030	57,-	71,-
GIANTCO								
G-Buddy 50 (4 t.)	Alle	110016		98,-	123,-	110032	59,-	74,-
Sprint 50 (4 t.)	Alle	110016		98,-	123,-	110032	59,-	74,-
Stealth 50 (4 t.)	Alle	110016		98,-	123,-	110032	59,-	74,-
Venus 50 (4 t.)	Alle	110016		98,-	123,-	110032	59,-	74,-
GILERA								
		110012		138,-	173,-	110031	57,-	71,-
HONDA								
SFX 50	Alle	110015		138,-	173,-			
HYOSUNG								
SB 50 M (Cab)	99>	110018		159,-	199,-	110034	59,-	74,-
SF 50 B (Racing)	00>	110019		159,-	199,-	110034	59,-	74,-
SF 50 R (Rally)	00>	110019		159,-	199,-	110034	59,-	74,-
KEEWAY								
Focus 50 - Euro 2	Alle	110014	Lgd. 80mm	138,-	173,-	110031	57,-	71,-
Focus 50 - Euro 1	Alle	110013	Lgd. 65mm	135,-	169,-	110031	57,-	71,-
Matrix 50 - Euro 2	Alle	110014	Lgd. 80mm	138,-	173,-	110031	57,-	71,-
Matrix 50 - Euro 1	Alle	110013	Lgd. 65mm	135,-	169,-	110031	57,-	71,-
PEXMA								
KD 50 (4 t.)	Alle	110016		98,-	123,-	110032	59,-	74,-
PEUGEOT								
Buxy 50	Alle	110015		138,-	173,-			
Speedake 50	Alle	110015		138,-	173,-			
Speedfight 1 AC/LC 50	Alle	110015		138,-	173,-			
Speedfight 2 AC/LC 50	Alle	110015		138,-	173,-			
Squab 50	Alle	110015		138,-	173,-			
TKR 50	Alle	110015		138,-	173,-			
Trekker 50	Alle	110015		138,-	173,-			
V-Clie 50 (4 t.)	Alle	110016		98,-	123,-	110032	59,-	74,-
Vivacity 50	03>	110015		138,-	173,-			
Zenith 50	Alle	110015		138,-	173,-			
PGO								
Big Max 50	Alle	110015		138,-	173,-	110033	57,-	71,-
Black Magic 50	Alle	110015		138,-	173,-			
Dr. Big 50	Alle	110015		138,-	173,-	110033	57,-	71,-
Galaxy 50	Alle	110015		138,-	173,-			

Bøsning til kickstarteraksels
Bussning till kickstart axels

Passer til: Aprilia,
CPI/Keeway (Euro 1)
Minarelli, Yamaha.



20x30x13mm
Varenr. 110020

DKK SEK

48,- 60,-

Bøsning til kickstarteraksels
Bussning till kickstart axels

Passer til:
CPI/Keeway (Euro 2)

20x46x15mm
Varenr. 110021

DKK SEK

55,- 69,-





Märke/model	Årg.	Kickstarteraxel Varenr. Spec.	Fjeder for kickstarteraxel Varenr.		
Märke/modell	Årg.	Kickstart axel Art.nr. Spec.	DKK	SEK	Fjäder för kickstart axel Art.nr. DKK SEK
PGO					
G-Max 50	Alle	110015	138,-	173,-	
Hot-50	Alle	110015	138,-	173,-	110033 57,- 71,-
Ligero 50	Alle	110015	138,-	173,-	
PMX Sport/Naked 50	Alle	110015	138,-	173,-	
Rodeo Show 50	Alle	110015	138,-	173,-	
Tornado 50	Alle	110015	138,-	173,-	
T-Rex 50	Alle	110015	138,-	173,-	
PIAGGIO/VESPA					
	Alle	110012	138,-	173,-	110031 57,- 71,-
SANELI					
Bahne 50 (4 t.)	Alle	110016	98,-	123,-	110032 59,- 74,-
STRANGER					
X-fight 50 (4 t.)	Alle	110016	98,-	123,-	110032 59,- 74,-
SUZUKI					
Adress AP-50	Alle	110017	138,-	173,-	
SYM					
DD 50	Alle	110015	138,-	173,-	
TEXAS					
Chili 50 (4 t.)	Alle	110016	98,-	123,-	110032 59,- 74,-
City 50 (4 t.)	Alle	110016	98,-	123,-	110032 59,- 74,-
Flash 50 (4 t.)	Alle	110016	98,-	123,-	110032 59,- 74,-
Free 50 (4 t.)	Alle	110016	98,-	123,-	110032 59,- 74,-
TMS					
Retro 50 (4 t.)	Alle	110016	98,-	123,-	110032 59,- 74,-
S3 50 (4 t.)	Alle	110016	98,-	123,-	110032 59,- 74,-
Z2 50 (4 t.)	Alle	110016	98,-	123,-	110032 59,- 74,-
TOBILINER					
QT 50 (4 t.)	Alle	110016	98,-	123,-	110032 59,- 74,-
YAMAHA					
(Vandret cylinder)	Alle	110010	Lige type 138,-	173,-	110030 57,- 71,-
(Lodret cylinder)	Alle	110011	Buet type 138,-	173,-	110030 57,- 71,-
YIYING					
Stranger 50 (4 t.)	Alle	110016	98,-	123,-	110032 59,- 74,-

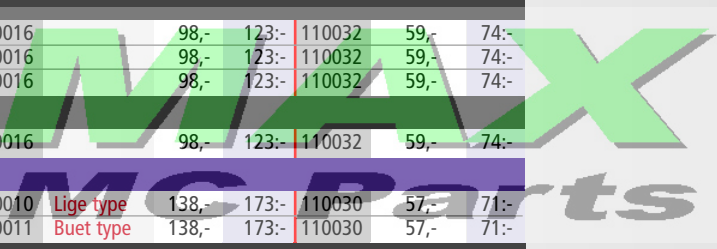

Forhandlere
Återförsäljare
s. 2

Stikord
Sökord
s. 4

Tøj/hjelme
Kläder/
hjälm
s. 6

Dæk og
slanger
Däck och
slangar
s. 15

Olje / spray
Olja / spray
s. 26

Kæder /
tandhjul
Kedjor /
drev
s. 43

Bremselede
Bromsdelar
s. 48

Låse
Lås
s. 93

Batteri
Batteri
s. 96

Cylinder /
topstykke
Cylinder /
topplock
s. 105

**Motordele
Motordeklar
s. 137**

Karburator
- Luftfilter
Förgasare
- Luftfilter
s. 208

El-dele
tændrør
Elektriskt
tändstift
s. 222

Udstødning
Avgassystem
s. 246

Forgaffel
Støddæmpere
Framgaffel
Støtdämpare
s. 260

Kabler
Wire
s. 266

Styr og
greb
Styre och
handtag
s. 272

Spejle
Speglar
s. 282

Blinklygter
Baglygter
Blinkers
Baklykte
s. 284

Støtteben
Topboks, mm.
Stödd
Topbbox, mm
s. 291

Rep. bøger
værktøj
Rep. böcker
Verktyg
s. 297

**Generic**

XOR2 50CC

RACE

IDEO

TRIGGER X

TRIGGER SM

XOR2 125CC

TRIGGER SM

30 el. 45 km/t

14.998,-

+ leveringsomkostninger

DEN INNOVATIVE SUPER MOTARD!

Det er tid til at brænde noget gummi af! TRIGGER SM er lig med avanceret og banebrydende teknologi – du er garanteret høj køreglæde og en præstation i topklasse! Udstyr, som "up-side-down" forgaffel, skivebremser, håndbeskyttere og lette alufælge, gør køreturen til en ren nydelse!

MOTOR:	En cylinder, vandkølet, 2-takts motor. 49,6 cc. Kompression 7:1.
TRANSMISSION:	45 km: 6 gear, fodskifte. Kædetræk. 30 km: 3 gear, fodskifte. Kædetræk.
STEL:	Rørramme i stål
AFFJEDRING:	For: Upside down forgaffel Bag: Mono shock dæmper
BREMSER:	For: Waveskive Ø 280 mm Bag: Waveskive Ø 220 mm
HJUL:	For: 100/80 x 17 / Bag: 130/80 x 17
LÆNGDE:	2035 mm
VÆGT:	94 kg
TANK:	10 liter
FARVE:	Sort ■ sort/orange ■ hvid/sort

Silkolene
smøremidler anbefales
af Generic Motors! ...



Gemt udstødning bag



Elektronisk instrumentbræt



Wavebremseskive for/bag

DESIGN AUSTRIA
www.genericmotor.dk



Importør: ScanMI ApS
Tlf. +45 73 15 11 00



Beta
the play bike

RR 50 ENDURO

STEL:	Stålstel.
MOTOR:	Minarellimotor AM 6. Væskekølet. En 49,7 cc cylinder. To-takt. Dell'Orto karburator. 6 gear.
HJUL:	For: 21" / 260 mm. bremseskive. Bag: 18" / 220 mm. bremseskive.
LÆNGDE:	2030 mm.
BREDDE:	790 mm.
SÆDEHØJDE:	925 mm.
TØRVÆGT:	83 kg.
FORGAFFEL:	36 mm. hydraulisk. Monodæmper bag.

45 km/t

21.998,-

Ekskl. leveringsomkostninger



Beta anbefaler
Silkolene
olie!

Importør: **SCANMI** Tlf. +45 73 15 11 00

Design og produktion 100 % italiensk!

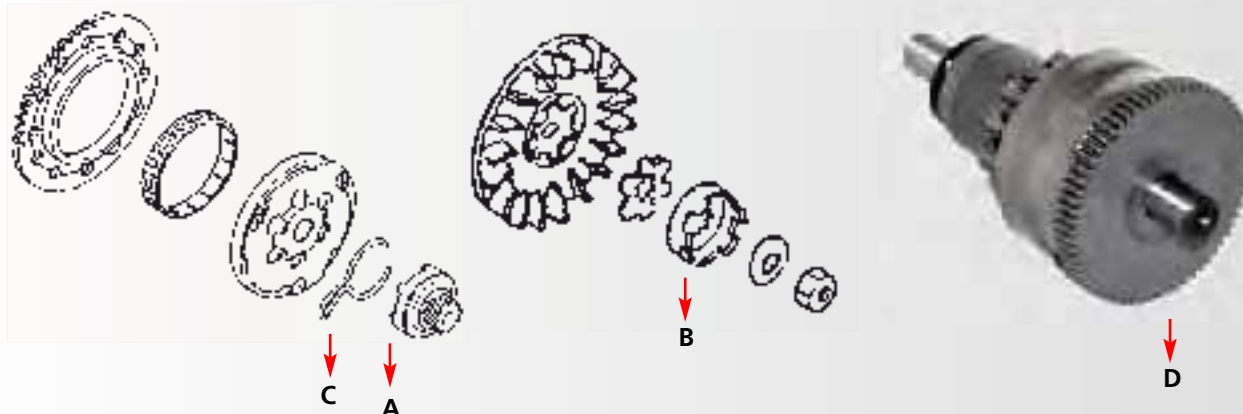

Se fotos på næste side....

Mærke/model	Årg.	Startersnekke A Varenr.			Gribeskål B Varenr.			Gaffelfjeder C Varenr.			Starterdrev D Varenr.		
Mærke/modell	Årg.	Startsnække A Art.nr.	DKK	SEK	Gribeskål B Art.nr.	DKK	SEK	Gaffelfjeder C Art.nr.	DKK	SEK	Startdrev Art.nr.	DKK	SEK
APRILIA													
Amico 50	Alle	110036	91,-	114,-	110035	42,-	53,-	110027	31,-	39,-			
Area 51 LC 50	Alle	110036	91,-	114,-	110035	42,-	53,-	110026	31,-	39,-			
Gulliver 50	Alle	110036	91,-	114,-	110035	42,-	53,-	110026	31,-	39,-			
Rally AC 50	Alle	110036	91,-	114,-	110035	42,-	53,-	110026	31,-	39,-			
Scarabeo 50	Alle	110036	91,-	114,-	110035	42,-	53,-	110026	31,-	39,-			
Sonic AC 50	Alle	110036	91,-	114,-	110035	42,-	53,-	110026	31,-	39,-			
Sonic LC 50	Alle	110036	91,-	114,-	110035	42,-	53,-	110026	31,-	39,-			
SR - www AC 50	Alle	110036	91,-	114,-	110035	42,-	53,-	110026	31,-	39,-			
SR-50 AC 50	Alle	110036	91,-	114,-	110035	42,-	53,-	110026	31,-	39,-			
SR-Racing 50, Stealth, Netscaper LC	Alle	110036	91,-	114,-	110035	42,-	53,-	110026	31,-	39,-			
SR-Replica LC (Minarelli) 50	Alle	110036	91,-	114,-	110035	42,-	53,-	110026	31,-	39,-			
AVANTI													
9 N 50 (4 t.)	Alle	110039	59,-	74,-	110056	68,-	85,-	110055	29,-	36,-	110042	178,-	223,-
Sport Classic 50 (4 t.)	Alle	110039	59,-	74,-	110056	68,-	85,-	110055	29,-	36,-	110042	178,-	223,-
Eagle 50 (4 t.)	Alle	110039	59,-	74,-	110056	68,-	85,-	110055	29,-	36,-	110042	178,-	223,-
Avanti Wolf 50 (4 t.)	Alle	110039	59,-	74,-	110056	68,-	85,-	110055	29,-	36,-	110042	178,-	223,-
BAOTAIN													
BT49QT-7 50 (4 t.)	Alle	110039	59,-	74,-	110056	68,-	85,-	110055	29,-	36,-	110042	178,-	223,-
BT49QT-9 50 (4 t.)	Alle	110039	59,-	74,-	110056	68,-	85,-	110055	29,-	36,-	110042	178,-	223,-
BT49QT-11 50 (4 t.)	Alle	110039	59,-	74,-	110056	68,-	85,-	110055	29,-	36,-	110042	178,-	223,-
BT49QT-12C 50 (4 t.)	Alle	110039	59,-	74,-	110056	68,-	85,-	110055	29,-	36,-	110042	178,-	223,-
BT49QT-12 50 (4 t.)	Alle	110039	59,-	74,-	110056	68,-	85,-	110055	29,-	36,-	110042	178,-	223,-
BENDA													
Scout 50 (4 t.)	Alle	110039	59,-	74,-	110056	68,-	85,-	110055	29,-	36,-	110042	178,-	223,-
CPI													
Aragon 50 (Euro 2)	Alle	110037	205,-	256,-	110038	41,-	51,-	110028	31,-	39,-			
Formula R 50 (Euro 2)	Alle	110037	205,-	256,-	110038	41,-	51,-	110028	31,-	39,-			
Hussar 50	Alle	110037	205,-	256,-	110038	41,-	51,-	110028	31,-	39,-			
Oliver/City 50 (Euro 2)	Alle	110037	205,-	256,-	110038	41,-	51,-	110028	31,-	39,-			
Popcorn 50	Alle	110037	205,-	256,-	110038	41,-	51,-	110028	31,-	39,-			
FYM													
QT 50	Alle	110039	59,-	74,-							110042	178,-	223,-
GIANTCO													
G-Buddy 50 (4 t.)	Alle	110039	59,-	74,-	110056	68,-	85,-	110055	29,-	36,-	110042	178,-	223,-
Sprint 50 (4 t.)	Alle	110039	59,-	74,-	110056	68,-	85,-	110055	29,-	36,-	110042	178,-	223,-
Stealth 50 (4 t.)	Alle	110039	59,-	74,-	110056	68,-	85,-	110055	29,-	36,-	110042	178,-	223,-
Venus 50 (4 t.)	Alle	110039	59,-	74,-	110056	68,-	85,-	110055	29,-	36,-	110042	178,-	223,-
GILERA													
Typhoon 50	94-97				110051	21,-	26,-						
Storm 50	94-95				110051	21,-	26,-						
Easy Moving 50	95-96				110051	21,-	26,-						
Dna 50	00->				110054	41,-	51,-						
Ice 50	01->				110054	41,-	51,-						
Runner Purejet 50	97->				110054	41,-	51,-						
Stalker 50	97->				110054	41,-	51,-						
Typhoon 50	00->				110054	41,-	51,-						

Märke/model	Årg.	Startersnekke A Varenr.	DKK		SEK		Gribeskål B Varenr.	DKK		SEK		Gaffelfjeder C Varenr.	DKK		SEK		Starterdrev D Varenr.	DKK		SEK		
Märke/modell	Årg.	Startsnäcka A Art.nr.	DKK	SEK	Art.nr.	DKK	SEK	Art.nr.	DKK	SEK	Art.nr.	DKK	SEK	Art.nr.	DKK	SEK	Art.nr.	DKK	SEK	Art.nr.	DKK	SEK
HOOPER																						
One 50 (4 t.)	Alle	110039	59,-	74,-	110056	68,-	85,-	110055	29,-	36,-	110042	178,-	223,-									
KEEWAY																						
Focus 50	Alle	110037	205,-	256,-	110038	41,-	51,-	110028	31,-	39,-												
Matrix 50	Alle	110037	205,-	256,-	110038	41,-	51,-	110028	31,-	39,-												
KYMCO																						
Agility 50 (4 t.)	Alle	110039	59,-	74,-	110056	68,-	85,-	110055	29,-	36,-	110042	178,-	223,-									
Super 8 50 (4 t.)	Alle	110039	59,-	74,-	110056	68,-	85,-	110055	29,-	36,-	110042	178,-	223,-									
PEUGEOT																						
Buxy 50	94->				110053	41,-	51,-															
Elyseo 50	99->				110053	41,-	51,-															
Elystar 50	03->				110053	41,-	51,-															
Looxor 50	01->				110053	41,-	51,-															
Metal X 50	02->				110053	41,-	51,-															
Speedake 50	97->				110053	41,-	51,-															
Speedfight AC 50	97->				110053	41,-	51,-															
Squab 50	95->				110053	41,-	51,-															
V-Clic 50 (4 t.)	Alle	110039	59,-	74,-	110056	68,-	85,-	110055	29,-	36,-	110042	178,-	223,-									
Vivacity 50	99->				110053	41,-	51,-															
Trekker 50	98->				110053	41,-	51,-															
Zenith 50	94->				110053	41,-	51,-															
X-fight 50/X-race 50	03->				110053	41,-	51,-															
PEXMA																						
KDQT 50 (4 t.)	Alle	110039	59,-	74,-	110056	68,-	85,-	110055	29,-	36,-	110042	178,-	223,-									
PIAGGIO/VESPA																						
Diesis 50	01->				110054	41,-	51,-															
Free 50	00->				110054	41,-	51,-															
Fly 2T/4T 50	04->				110054	41,-	51,-															
NRG Extreme 50	99->				110054	41,-	51,-															
NRG 50	94-96				110051	21,-	26,-															
RST MC2/MC3 50	96->				110054	41,-	51,-															
Liberty 50	97->				110054	41,-	51,-															
Purejet 50	02->				110054	41,-	51,-															
Vespa ET2 50	97->				110054	41,-	51,-															
ET2 Injection 50	97->				110054	41,-	51,-															
ET4 50	00-02				110054	41,-	51,-															
Zip 50	94-97				110051	21,-	26,-															
Quartz 50	92-96				110051	21,-	26,-															
SANELI																						
Bahne 50 (4 t.)	Alle	110039	59,-	74,-	110056	68,-	85,-	110055	29,-	36,-	110042	178,-	223,-									
STRANGER																						
X-fight 50 (4 t.)	Alle	110039	59,-	74,-							110042	178,-	223,-									
TEXAS																						
Chili 50 (4 t.)	Alle	110039	59,-	74,-	110056	68,-	85,-	110055	29,-	36,-	110042	178,-	223,-									
City 50 (4 t.)	Alle	110039	59,-	74,-	110056	68,-	85,-	110055	29,-	36,-	110042	178,-	223,-									
Flash 50 (4 t.)	Alle	110039	59,-	74,-	110056	68,-	85,-	110055	29,-	36,-	110042	178,-	223,-									
Free 50 (4 t.)	Alle	110039	59,-	74,-	110056	68,-	85,-	110055	29,-	36,-	110042	178,-	223,-									
TMS																						
Retro 50 (4 t.)	Alle	110039	59,-	74,-	110056	68,-	85,-	110055	29,-	36,-	110042	178,-	223,-									
S3 50 (4 t.)	Alle	110039	59,-	74,-	110056	68,-	85,-	110055	29,-	36,-	110042	178,-	223,-									
Z2 50 (4 t.)	Alle	110039	59,-	74,-	110056	68,-	85,-	110055	29,-	36,-	110042	178,-	223,-									
TOBILINER																						
QT 50 (4 t.)	Alle	110039	59,-	74,-							110042	178,-	223,-									
YAMAHA																						
Aerox 50	Alle	110036	91,-	114,-	110035	42,-	53,-	110026	31,-	39,-												
Axis 50	Alle	110036	91,-	114,-	110035	42,-	53,-	110026	31,-	39,-												
Bump 50	Alle	110036	91,-	114,-	110035	42,-	53,-	110027	31,-	39,-												
BW's 50	Alle	110036	91,-	114,-	110035	42,-	53,-	110027	31,-	39,-												
BW's N.G. 50	Alle	110036	91,-	114,-	110035	42,-	53,-	110027	31,-	39,-												
Jog Artistic - Fine Selection 50	Alle	110036	91,-	114,-	110035	42,-	53,-	110026	31,-	39,-												
Jog Space Innovation 50	Alle	110036	91,-	114,-	110035	42,-	53,-	110026	31,-	39,-												
Jog-R 50	Alle	110036	91,-	114,-	110035	42,-	53,-	110026	31,-	39,-												
Jog-RR 50	Alle	110036	91,-	114,-	110035	42,-	53,-	110026	31,-	39,-												
Neo's 50	Alle	110036	91,-	114,-	110035	42,-	53,-	110026	31,-	39,-												
Slider 50	Alle	110036	91,-	114,-	110035	42,-	53,-	110027	31,-	39,-												
Spy 50	Alle	110036	91,-	114,-	110035	42,-	53,-	110027	31,-	39,-												
Why 50	Alle	110036	91,-	114,-	110035	42,-	53,-	110026	31,-	39,-												
YIYANG																						
Stranger 50 (4 t.)	Alle	110039	59,-	74,-	110056	68,-	85,-	110055	29,-	36,-	110042	178,-	223,-									



110035



110036

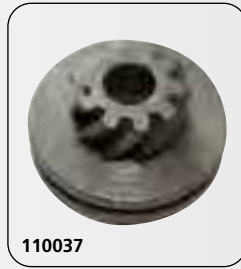

110037



110038



110039



110042



110026 - (Lige)

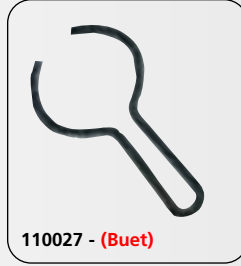

110027 - (Buet)

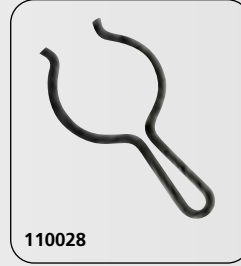

110028



110051



110053



110054



110055



110056

MAX
Mo Parts
 MADE IN ITALY!

Læs mere på www.betamotor.dk



Beta
 the play bike

ARK 50 RR

STEL: Stålrørstel.
MOTOR: Minarellimotor.
 Luftkølet. En 49 cc cylinder.
 2-takt. Dell'Orto karburator.
 CVT gear.
HJUL: For: 13" / 190 mm. bremse­skive.
 Bag: 13" / 110,5 mm. bremse­skive.
LÆNGDE: 1740 mm.
BREDDE: 750 mm.
SÆDEHØJDE: 830 mm.
TØRVÆGT: 84 kg.
FORGAFFEL: 32 mm. hydraulisk.
 Monodæmper bag.

30 el. 45 km/t
15.998,-
 Uden leveringsomkostninger



Beta anbefaler
Silkolene
 olie!

Importør: **SCANMI** Tlf. +45 73 15 11 00

Design og produktion  100 % italiensk!

DKK Startersnekke
SEK Start snäcka

GILERA/PIAGGIO 50
 2/4 takt



Varenr. 110043

DKK 50,- **SEK 63,-**

DKK Starter-tandhjul
SEK Start-drev

CPI/GENERIC/GIANTCO
 KEEWAY.



Varenr. 110044

DKK 224,- **SEK 280,-**



DKK Nålefiber-leje
SEK Nål lager

CPI/GENERIC/GIANTCO/KEEWAY.

Varenr. 110045

DKK 156,- **SEK 195,-**



DKK Starter-mellemhjul
SEK for starter
DKK Startdrev för startmotor

CPI/GENERIC/GIANTCO/KEEWAY.

Varenr. 110046

DKK 163,- **SEK 204,-**



DKK Startersnekke
SEK Start snäcka

PGO

Varenr. 110047

DKK 51,- **SEK 64,-**



DKK Gribeskål
SEK Grepp skål

PGO

Varenr. 110048

DKK 42,- **SEK 53,-**



DKK Låseskive for blæserhjul
SEK Bromsskiva f. bakhjul/framhjul

Passer til Aprilia,
 Yamaha, Minarelli

Varenr. 110050

DKK 16,- **SEK 20,-**



DKK Møtrik kit (for variator)
SEK Motorkit (för variator)

Aprilia / Yamaha (Minarelli)

Ø10x1,25 mm

Varenr. 110081

DKK 27,- **SEK 34,-**

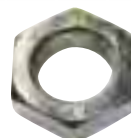

DKK Møtrik for variator
SEK Motorkit för variator

CPI/GENERIC/GIANTCO/KEEWAY.

Ø 12 x 1,25 mm.

Varenr. 110092

DKK 11,- **SEK 14,-**



DKK Låseskive for blæserhjul
SEK Bromsskiva f. bakhjul/framhjul

CPI: Popcorn, Hussar og Oliver, alle årgange.
 GENERIC: Ideo 50, Race 50, XOR 50
 KEEWAY: Focus & Matrix, alle årgange

Varenr. 110052

DKK 29,- **SEK 36,-**



DKK Møtrik for variator
SEK Motorkit för variator

Aprilia / Yamaha / Minarelli

Ø10x1,25 mm

Gilera / Piaggio

Ø10x1,25 mm

Varenr. 110090

DKK 96,- **SEK 120,-**



DKK Skive for variator
SEK Skiva för variator

CPI/GENERIC/GIANTCO/KEEWAY.

Varenr. 110093

DKK 16,- **SEK 20,-**



DKK Blæserhjul
SEK Fläkt



Suzuki: AP-50, Katana AC/LC 50, Streetmagic 50

Varenr. 034507

DKK 95,- **SEK 119,-**





MÆRKE/MODEL	ÅRG.	Varenr.		
MÄRKE/MODELL	ÅRG.	Art.NR.	 DKK	 SEK
ADLY				
Cat 50	Alle	110040	155,-	194,-
Jet 50	Alle	110040	155,-	194,-
Silver Fox 50	Alle	110040	155,-	194,-
Super Sonic 50	Alle	110040	155,-	194,-
Thunder Bike 50	Alle	110040	155,-	194,-



APRILIA				
Amico 50	Alle	110040	155,-	194,-
Area 51 LC 50	98->	110040	155,-	194,-
Classic 50	Alle	110040	155,-	194,-
Gulliver 50	Alle	110040	155,-	194,-
Rally AC 50	Alle	110040	155,-	194,-
Scarabeo 50	Alle	110040	155,-	194,-
Sonic AC 50	Alle	110040	155,-	194,-
Sonic LC 50	Alle	110040	155,-	194,-
SR - www AC 50	97->	110040	155,-	194,-
SR-50 AC	->96	110040	155,-	194,-
SR-50 AC	->93	110040	155,-	194,-
SR-Racing 50, Stealth, Netscaper LC	Alle	110040	155,-	194,-
SR-Replica LC 50 (Minarelli)	->00	110040	155,-	194,-
SR-Replica-2000 LC 50 (Morini)	00->	110040	155,-	194,-

BENELLI				
491 GT 50	97->	110040	155,-	194,-
491 Sport 50	97->	110040	155,-	194,-
K2/LC 50	Alle	110040	155,-	194,-

BETA				
Ark AC 50	Alle	110040	155,-	194,-
Ark LC 50	Alle	110040	155,-	194,-

CPI				
Aragon 50 (Euro 2)	Alle	110041	394,-	493,-
Formula R 50 (Euro 2)	Alle	110041	394,-	493,-
Hussar 50	Alle	110041	394,-	493,-
Oliver/City 50 (Euro 2)	Alle	110041	394,-	493,-
Popcorn 50	Alle	110041	394,-	493,-

GENERIC				
Ideo 50	Alle	110041	394,-	493,-
Race 50	Alle	110041	394,-	493,-
Xor 50	Alle	110041	394,-	493,-

MÆRKE/MODEL	ÅRG.	Varenr.		
MÄRKE/MODELL	ÅRG.	Art.NR.	 DKK	 SEK
KEEWAY				
F-act 50	Alle	110041	394,-	493,-
Flash 50	Alle	110041	394,-	493,-
Focus 50	Alle	110041	394,-	493,-
Matrix 50	Alle	110041	394,-	493,-

MALAGUTI				
F10 AC 50	Alle	110040	155,-	194,-
F12 Phantom AC 50	Alle	110040	155,-	194,-
F15 Firefox LC 50	Alle	110040	155,-	194,-

YAMAHA				
Aerox 50	97->	110040	155,-	194,-
Axis 50	95->	110040	155,-	194,-
Bump 50	97->	110040	155,-	194,-
BW's 50	Alle	110040	155,-	194,-
BW's N.G. 40	Alle	110040	155,-	194,-
Jog Artistic - Fine Selection 50	Alle	110040	155,-	194,-
Jog Space Innovation 50	98->	110040	155,-	194,-
Jog-R 50	03->	110040	155,-	194,-
Jog-RR 50	03->	110040	155,-	194,-
Neo's 50	97->	110040	155,-	194,-
Slider 50	01->	110040	155,-	194,-
Spy 50	Alle	110040	155,-	194,-
Why 50	99->	110040	155,-	194,-



MÆRKE/MODEL	Årg.	Blæserkappe 1		Blæserkappe 2	
		Varenr.	Art.nr.	Varenr.	Art.nr.
MÅRKE/MODELL	Årg.	Cylinderkåpa 1		Cylinderkåpa 2	
		Art.nr.	DKK SEK	Art.nr.	DKK SEK
ADLY					
Cat 50	Alle	110072	91,- 114,-		
Jet 50	Alle	110071	91,- 114,-		
Silver Fox 50	Alle	110072	91,- 114,-		
Super Sonic 50	Alle	110071	91,- 114,-		
Thunder Bike 50	Alle	110071	91,- 114,-		
APRILIA					
Amico 50	Alle	110072	91,- 114,-		
Gulliver 50	Alle	110071	91,- 114,-		
Rally AC 50	->96	110071	91,- 114,-		
Scarabeo 50	Alle	110071	91,- 114,-		
Sonic AC 50	98->	110071	91,- 114,-		
SR - www AC 50	97->	110071	91,- 114,-		
SR-50 AC 50	->96	110071	91,- 114,-		
AVANTI					
9 N 50 (4 t.)	Alle	110065	120,- 150,-	110066	225,- 281,-
Sport Classic 50 (4 t.)	Alle	110065	120,- 150,-	110066	225,- 281,-
Eagle 50 (4 t.)	Alle	110065	120,- 150,-	110066	225,- 281,-
Avanti Wolf 50 (4 t.)	Alle	110065	120,- 150,-	110066	225,- 281,-
BAOTAIN					
BT49QT-7 50 (4 t.)	Alle	110065	120,- 150,-	110066	225,- 281,-
BT49QT-9 50 (4 t.)	Alle	110065	120,- 150,-	110066	225,- 281,-
BT49QT-11 50 (4 t.)	Alle	110065	120,- 150,-	110066	225,- 281,-
BT49QT-12C 50 (4 t.)	Alle	110065	120,- 150,-	110066	225,- 281,-
BT49QT-12 50 (4 t.)	Alle	110065	120,- 150,-	110066	225,- 281,-
BENDA					
Scout 50 (4 t.)	Alle	110065	120,- 150,-	110066	225,- 281,-
BENELLI					
491 GT 50	97->	110071	91,- 114,-		
491 Sport 50	97->	110071	91,- 114,-		
BETA					
Ark AC 50		110071	91,- 114,-		
Ark LC 50		110071	91,- 114,-		
CPI					
Aragon 50 (Euro 2)	Alle	110078	89,- 111,-		
ATV 50 cc		110078	89,- 111,-		
Formula R 50 (Euro 2)	Alle	110078	89,- 111,-		
Hussar 50	Alle	110078	89,- 111,-		
Oliver/City 50 (Euro 2)	03->	110078	89,- 111,-		
Popcorn 50	Alle	110078	89,- 111,-		
FYM					
QT 50 (4 t.)	Alle	110065	120,- 150,-	110066	225,- 281,-
GIANTCO					
G-Buddy 50 (4 t.)	Alle	110065	120,- 150,-	110066	225,- 281,-
Sprint 50 (4 t.)	Alle	110065	120,- 150,-	110066	225,- 281,-
Stealth 50 (4 t.)	Alle	110065	120,- 150,-	110066	225,- 281,-
Venus 50 (4 t.)	Alle	110065	120,- 150,-	110066	225,- 281,-
HOOPER					
One 50 (4 t.)	Alle	110065	120,- 150,-	110066	225,- 281,-

MÆRKE/MODEL	Årg.	Blæserkappe 1		Blæserkappe 2	
		Varenr.	Art.nr.	Varenr.	Art.nr.
MÅRKE/MODELL	Årg.	Cylinderkåpa 1		Cylinderkåpa 2	
		Art.nr.	DKK SEK	Art.nr.	DKK SEK
HYOSUNG					
SB 50 M (Cab)	99>	110121	59,- 74,-		
SF 50 B (Racing)	00>	110121	59,- 74,-		
SF 50 R (Rally)	00>	110121	59,- 74,-		
KEEWAY					
F-act 50	Alle	110078	89,- 111,-		
Flash 50	Alle	110078	89,- 111,-		
Focus 50	Alle	110078	89,- 111,-		
Matrix 50	Alle	110078	89,- 111,-		
KREIDLER					
Easy Rider 50	Alle	110071	91,- 114,-		
KYMCO					
Agility 50 (4 t.)	Alle	110065	120,- 150,-	110066	225,- 281,-
Super 8 50 (4 t.)	Alle	110065	120,- 150,-	110066	225,- 281,-
MALAGUTI					
F10 AC 50	Alle	110071	91,- 114,-		
F12 Phantom AC 50	Alle	110071	91,- 114,-		
PEUGEOT					
V-Clic 50 (4 t.)	Alle	110065	120,- 150,-	110066	225,- 281,-
PEXMA					
KDQT 50 (4 t.)	Alle	110065	120,- 150,-	110066	225,- 281,-
SANELI					
Bahne 50 (4 t.)	Alle	110065	120,- 150,-	110066	225,- 281,-
TEXAS					
Chili 50 (4 t.)	Alle	110065	120,- 150,-	110066	225,- 281,-
City 50 (4 t.)	Alle	110065	120,- 150,-	110066	225,- 281,-
Flash 50 (4 t.)	Alle	110065	120,- 150,-	110066	225,- 281,-
Free 50 (4 t.)	Alle	110065	120,- 150,-	110066	225,- 281,-
TMS					
Retro 50 (4 t.)	Alle	110065	120,- 150,-	110066	225,- 281,-
S3 50 (4 t.)	Alle	110065	120,- 150,-	110066	225,- 281,-
Z2 50 (4 t.)	Alle	110065	120,- 150,-	110066	225,- 281,-
YAMAHA					
Axis 50	95->	110071	91,- 114,-		
Bump 50	97->	110072	100,- 125,-		
BW's 50	->96	110072	100,- 125,-		
BW's N.G. 50	96->	110072	100,- 125,-		
Jog Artistic Fine Selection 50	Alle	110071	91,- 114,-		
Jog Space Innovation 50	98->	110071	91,- 114,-		
Jog-R 50	03->	110071	91,- 114,-		
Neo's 50	97->	110071	91,- 114,-		
Slider 50	01->	110072	100,- 125,-		
Spy 50	Alle	110072	100,- 125,-		
Why 50	99->	110071	91,- 114,-		
YIYING					
Stranger 50 (4 t.)	Alle	110065	120,- 150,-	110066	225,- 281,-



MÆRKE/MODEL	ÅRG.	Varenr.	DKK	SEK
MÄRKE/MODELL	ÅRG.	Art.NR.	DKK	SEK
ADLY				
Cat 50	Alle	110073	91,-	114:-
Jet 50	Alle	110070	91,-	114:-
Silver Fox 50	Alle	110073	91,-	114:-
Super Sonic 50	Alle	110070	91,-	114:-
Thunder Bike 50	Alle	110070	91,-	114:-

MÆRKE/MODEL	ÅRG.	Varenr.	DKK	SEK
MÄRKE/MODELL	ÅRG.	Art.NR.	DKK	SEK
APRILIA				
Amico 50	Alle	110073	91,-	114:-
Gulliver 50	Alle	110070	91,-	114:-
Rally AC 50	96->	110070	91,-	114:-
Scarabeo 50	Alle	110070	91,-	114:-
Sonic AC 50	98->	110070	91,-	114:-
SR - www AC 50	97->	110070	91,-	114:-
SR-50 AC	96->	110070	91,-	114:-

MÆRKE/MODEL	ÅRG.	Varenr.	DKK	SEK
MÄRKE/MODELL	ÅRG.	Art.NR.	DKK	SEK
AVANTI				
9 N 50 (4 t.)	Alle	110079	89,-	111:-
Sport Classic 50 (4 t.)	Alle	110079	89,-	111:-
Eagle 50 (4 t.)	Alle	110079	89,-	111:-
Avanti Wolf 50 (4 t.)	Alle	110079	89,-	111:-

MÆRKE/MODEL	ÅRG.	Varenr.	DKK	SEK
MÄRKE/MODELL	ÅRG.	Art.NR.	DKK	SEK
BAOTAIN				
BT49QT-7 50 (4 t.)	Alle	110079	89,-	111:-
BT49QT-9 50 (4 t.)	Alle	110079	89,-	111:-
BT49QT-11 50 (4 t.)	Alle	110079	89,-	111:-
BT49QT-12C 50 (4 t.)	Alle	110079	89,-	111:-
BT49QT-12 50 (4 t.)	Alle	110079	89,-	111:-

MÆRKE/MODEL	ÅRG.	Varenr.	DKK	SEK
MÄRKE/MODELL	ÅRG.	Art.NR.	DKK	SEK
BENDA				
Scout 50 (4 t.)	Alle	110079	89,-	111:-

MÆRKE/MODEL	ÅRG.	Varenr.	DKK	SEK
MÄRKE/MODELL	ÅRG.	Art.NR.	DKK	SEK
BENELLI				
491 GT 50	97->	110070	91,-	114:-
491 Sport 50	97->	110070	91,-	114:-

MÆRKE/MODEL	ÅRG.	Varenr.	DKK	SEK
MÄRKE/MODELL	ÅRG.	Art.NR.	DKK	SEK
BETA				
Ark AC 50		110070	91,-	114:-
Ark LC 50		110070	91,-	114:-

MÆRKE/MODEL	ÅRG.	Varenr.	DKK	SEK
MÄRKE/MODELL	ÅRG.	Art.NR.	DKK	SEK
CPI				
Aragon 50 (Euro 2)	Alle	110077	89,-	111:-
ATV 50 cc	Alle	110077	89,-	111:-
Formula R 50 (Euro 2)	Alle	110077	89,-	111:-
Hussar 50	Alle	110077	89,-	111:-
Oliver/City 50 (Euro 2)	03->	110077	89,-	111:-
Popcorn 50	Alle	110077	89,-	111:-

MÆRKE/MODEL	ÅRG.	Varenr.	DKK	SEK
MÄRKE/MODELL	ÅRG.	Art.NR.	DKK	SEK
FYM				
QT 50	Alle	110079	89,-	111:-

MÆRKE/MODEL	ÅRG.	Varenr.	DKK	SEK
MÄRKE/MODELL	ÅRG.	Art.NR.	DKK	SEK
GIANTCO				
G-Buddy 50 (4 t.)	Alle	110079	89,-	111:-
Sprint 50 (4 t.)	Alle	110079	89,-	111:-
Stealth 50 (4 t.)	Alle	110079	89,-	111:-
Venus 50 (4 t.)	Alle	110079	89,-	111:-

MÆRKE/MODEL	ÅRG.	Varenr.	DKK	SEK
MÄRKE/MODELL	ÅRG.	Art.NR.	DKK	SEK
HOOPER				
One 50 (4 t.)	Alle	110079	89,-	111:-

MÆRKE/MODEL	ÅRG.	Varenr.	DKK	SEK
MÄRKE/MODELL	ÅRG.	Art.NR.	DKK	SEK
HYOSUNG (blæserdæksel udvendig)				
SB 50 M (Cab)	99>	110097	91,-	114:-
SF 50 R (Racing)	00>	110097	91,-	114:-
SF 50 R (Rally)	00>	110097	91,-	114:-

MÆRKE/MODEL	ÅRG.	Varenr.	DKK	SEK
MÄRKE/MODELL	ÅRG.	Art.NR.	DKK	SEK
HYOSUNG (blæserdæksel indvendig)				
SB 50 M (Cab)	99>	110098	91,-	114:-
SF 50 R (Racing)	00>	110098	91,-	114:-
SF 50 R (Rally)	00>	110098	91,-	114:-

MÆRKE/MODEL	ÅRG.	Varenr.	DKK	SEK
MÄRKE/MODELL	ÅRG.	Art.NR.	DKK	SEK
KEEWAY				
F-act 50	Alle	110077	89,-	111:-
Flash 50	Alle	110077	89,-	111:-
Focus 50	Alle	110077	89,-	111:-
Matrix 50	Alle	110077	89,-	111:-

MÆRKE/MODEL	ÅRG.	Varenr.	DKK	SEK
MÄRKE/MODELL	ÅRG.	Art.NR.	DKK	SEK
KREIDLER				
Easy Rider 50	Alle	110070	91,-	114:-

MÆRKE/MODEL	ÅRG.	Varenr.	DKK	SEK
MÄRKE/MODELL	ÅRG.	Art.NR.	DKK	SEK
KYMCO				
Agility 50 (4 t.)	Alle	110079	89,-	111:-
Super 8 50 (4 t.)	Alle	110079	89,-	111:-

MÆRKE/MODEL	ÅRG.	Varenr.	DKK	SEK
MÄRKE/MODELL	ÅRG.	Art.NR.	DKK	SEK
MALAGUTI				
F10 AC 50	Alle	110070	91,-	114:-
F12 Phantom AC 50	Alle	110070	91,-	114:-

MÆRKE/MODEL	ÅRG.	Varenr.	DKK	SEK
MÄRKE/MODELL	ÅRG.	Art.NR.	DKK	SEK
PEUGEOT				
V-Clic 50 (4 t.)	Alle	110079	89,-	111:-

MÆRKE/MODEL	ÅRG.	Varenr.	DKK	SEK
MÄRKE/MODELL	ÅRG.	Art.NR.	DKK	SEK
PEXMA				
KD 50 (4 t.)	Alle	110079	89,-	111:-

MÆRKE/MODEL	ÅRG.	Varenr.	DKK	SEK
MÄRKE/MODELL	ÅRG.	Art.NR.	DKK	SEK
SANELI				
Bahne 50 (4 t.)	Alle	110079	89,-	111:-

MÆRKE/MODEL	ÅRG.	Varenr.	DKK	SEK
MÄRKE/MODELL	ÅRG.	Art.NR.	DKK	SEK
STRANGER				
X-fight 50 (4 t.)	Alle	110079	89,-	111:-

MÆRKE/MODEL	ÅRG.	Varenr.	DKK	SEK
MÄRKE/MODELL	ÅRG.	Art.NR.	DKK	SEK
TOBILINER				
QT 50 (4 t.)	Alle	110079	89,-	111:-

MÆRKE/MODEL	ÅRG.	Varenr.	DKK	SEK
MÄRKE/MODELL	ÅRG.	Art.NR.	DKK	SEK
TEXAS				
Chili 50 (4 t.)	Alle	110079	89,-	111:-
City 50 (4 t.)	Alle	110079	89,-	111:-
Flash 50 (4 t.)	Alle	110079	89,-	111:-
Free 50 (4 t.)	Alle	110079	89,-	111:-

MÆRKE/MODEL	ÅRG.	Varenr.	DKK	SEK
MÄRKE/MODELL	ÅRG.	Art.NR.	DKK	SEK
TMS				
Retro 50 (4 t.)	Alle	110079	89,-	111:-
S3 50 (4 t.)	Alle	110079	89,-	111:-
Z2 50 (4 t.)	Alle	110079	89,-	111:-

MÆRKE/MODEL	ÅRG.	Varenr.	DKK	SEK
MÄRKE/MODELL	ÅRG.	Art.NR.	DKK	SEK
YAMAHA				
Axis 50	95->	110070	91,-	114:-
Bump 50	97->	110073	91,-	114:-
BW's 50	->96	110073	91,-	114:-
BW's N.G. 50	96->	110073	91,-	114:-
Jog Artistic -Fine Selection 50	Alle	110070	91,-	114:-
Jog Space Innovation 50	98->	110070	91,-	114:-
Jog-R 50	03->	110070	91,-	114:-
Neo's 50	97->	110070	91,-	114:-
Slider 50	01->	110073	91,-	114:-
Spy 50	Alle	110073	91,-	114:-
Why 50	99->	110070	91,-	114:-

MÆRKE/MODEL	ÅRG.	Varenr.	DKK	SEK
MÄRKE/MODELL	ÅRG.	Art.NR.	DKK	SEK
YIYING				
Stranger 50 (4 t.)	Alle	110079	89,-	111:-



MÆRKE/MODEL	ÅRG.
AVANTI	ÅRG.
9 N 50 (4 t.)	Alle
Sport Classic 50 (4 t.)	Alle
Eagle 50 (4 t.)	Alle
Avanti Wolf 50 (4 t.)	Alle
BAOTAIN	
BT49QT-7 50 (4 t.)	Alle
BT49QT-9 (4 t.)	Alle
BT49QT-11 (4 t.)	Alle
BT49QT-12C (4 t.)	Alle
BT49QT-12 (4 t.)	Alle
FYM	
QT 50 (4 t.)	Alle

MÆRKE/MODEL	ÅRG.
GIANTCO	
G-Buddy 50 (4 t.)	Alle
Sprint 50 (4 t.)	Alle
Stealth 50 (4 t.)	Alle
Venus 50 (4 t.)	Alle
HOOPER	
One 50 (4 t.)	Alle
KYMCO	
Agility 50 (4 t.)	Alle
Super 8 50 (4 t.)	Alle
PEUGEOT	
V-Clic 50 (4 t.)	Alle

MÆRKE/MODEL	ÅRG.
PEXMA	
KDQT 50 (4 t.)	Alle
SANELI	
Bahne 50 (4 t.)	Alle
TEXAS	
Chili 50 (4 t.)	Alle
City 50 (4 t.)	Alle
Flash 50 (4 t.)	Alle
Free 50 (4 t.)	Alle
TMS	
Retro 50 (4 t.)	Alle
S3 50 (4 t.)	Alle
Z2 50 (4 t.)	Alle
YIYING	
Stranger 50 (4 t.)	Alle

Udstødningsventil
Avgasventil



Varenr./art.nr. 138400 **99,-** **124,-**

Indsugningsventil
Insugsventil



Varenr./art.nr. 138401 **69,-** **86,-**

Indsugningsventilkit
Insugsventil sats



Varenr./art.nr. 138402 **125,-** **156,-**

Udstødningsventil kit
Avgas ventil sats



Varenr./art.nr. 138403 **125,-** **156,-**

Lås for ventil indsugning-/udstødning
Lås förventilinsug/avgas



Varenr./art.nr. 138450 **45,-** **56,-**

Knastaksel
Kamaxel



Varenr./art.nr. 138452 **234,-** **293,-**

Knastkædeskinne, øverst
Kamkedjestyre, øverst



Varenr./art.nr. 138453 **52,-** **65,-**

Knastkædeskinne, nederst
Kamkedjestyre, nederst



Varenr./art.nr. 138454 **74,-** **93,-**

Lejeoverfald kpl. med viparme
Lejeoverfald kpl. med viparme



Varenr./art.nr. 138455 **399,-** **499,-**

Oljepumpe
Oljapump



Varenr./art.nr. 110067 **99,-** **124,-**

Tandhjul f. oliepumpe
Drev till oljapump



Varenr./art.nr. 110068 **49,-** **61,-**

Oljefilter
Oljafilter



Varenr./art.nr. 110049 **38,-** **48,-**

Ventilmanchet
Ventilmanchet



Varenr./art.nr. 016309 **68,-** **85,-**

Knastkædestrammer
Kamkedjespännare



Varenr./art.nr. 057400 **103,-** **129,-**

Knastkæde
Kamkedja



Varenr./art.nr. 055086 **308,-** **385,-**

KØLERKAPPE
KYLAR KÅPA



MÆRKE/MODEL	Varenr.	DKK	SEK
MÆRKE/MODELL	Art.NR.		
APRILIA			
Amico 50	110225	105,-	131,-
Area 51 50	110225	105,-	131,-
Gulliver 50	110225	105,-	131,-
Rally 50	110225	105,-	131,-
Replica 50	110225	105,-	131,-
Scarabeo 50	110225	105,-	131,-
Sonic 50	110225	105,-	131,-
SR-50	110225	105,-	131,-
SR www 50	110225	105,-	131,-
Stealth 50	110225	105,-	131,-
BENELLI			
491 GT 50	110225	105,-	131,-
K2 50	110225	105,-	131,-
BETA			
Ark 50	110225	105,-	131,-
Quadro 50	110225	105,-	131,-

MÆRKE/MODEL	Varenr.	DKK	SEK
MÆRKE/MODELL	Art.NR.		
ITALJET			
Dragster 50	110225	105,-	131,-
MALAGUTI			
F12 Phantom 50	110225	105,-	131,-
F15 Fire Fox 50	110225	105,-	131,-
PEUGEOT			
Buxy 50	110226	105,-	131,-
Speedake 50	110226	105,-	131,-
Speedfight 50	110226	105,-	131,-
TKR 50	110226	105,-	131,-
Vivacity 50	110226	105,-	131,-
Zenith 50	110226	105,-	131,-
PIAGGIO/VESPA			
NRG 50	110226	105,-	131,-
NTT 50	110226	105,-	131,-
Typhoon 50	110226	105,-	131,-

MÆRKE/MODEL	Varenr.	DKK	SEK
MÆRKE/MODELL	Art.NR.		
YAMAHA			
Aerox 50	110226	105,-	131,-
Axis 50	110226	105,-	131,-
Bump 50	110226	105,-	131,-
BW's 50	110226	105,-	131,-
BW's N.G. 50	110226	105,-	131,-
Neo's 50	110226	105,-	131,-
Spy 50	110226	105,-	131,-
Zest 50	110226	105,-	131,-

DKK Kølerkappe til montering på blæsekappe. Forøger luftgennemstrømningen og giver en bedre køling.

SEK Flætkappa for montering på flætkåpen. Forhøjer luftgennemstrømningen og ger bedre kølning.

110225: Ø 103 mm. 110226: Ø 114 mm.

dealer satisfaction guaranteed

MAX
Our Complete Range Surpasses
MC Parts

JASO MA2

For the ultimate range of Jaso approved motorcycle lubricants, choose *Silkolene*.....

- Comprehensive Range
- Extensive Workshop Deals
- Excellent Technical Backup

FUCHS **Silkolene**
www.silkolene.com

Fuchs Silkolene products are available through our authorised network of distributors. SEE OUR WEBSITE FOR CONTACT DETAILS

Forhandlere
Återförsäljare
s. 2

Stikord
Sökord
s. 4

Tøj/hjelme
Klæder/
hjälmår
s. 6

Dæk og
slanger
Däck och
slangor
s. 15

Olje / spray
Olja / spray
s. 26

Kæder /
tandhjul
Kedjor /
drev
s. 43

Bremse dele
Bromsdelar
s. 48

Låse
Lås
s. 93

Batteri
Batteri
s. 96

Cylinder /
topstykke
Cylinder /
topplock
s. 105

Motor dele
Motor delar
s. 137

Karburator
- Luftfilter
Förgasare
- Luftfilter
s. 208

El-dele
tændrør
Elektriskt
tändstift
s. 222

Udstødning
Avgassystem
s. 246

Forgaffel
Støddæmpere
Framgaffel
Stötdämpare
s. 260

Kabler
Wire
s. 266

Styr og
greb
Styre och
handtag
s. 272

Spejle
Speglar
s. 282

Blinklygter
Baglygter
Blinkers
Baklykte
s. 284

Støtteben
Topboks, mm.
Stödd
Toppbox, mm
s. 291

Rep. bøger
værktøj
Rep. böcker
Verktyg
s. 297